



ONAP PNF Plug and Play for Guilin (R7, 3Q 2020)







- ONAP and PNF Plug and Play for 5G RAN
- 5G Use Case Team



PNF Plug and Play CASABLANCA IMPROVEMENTS OVERVIEW

- ONAP and PNF Plug and Play for 5G RAN
- 5G Use Case Team

Casablanca R3 Summary Overview

TOPIC	ICON	DESCRIPTION
PNF Registration Handler (PRH) Improvements		New VES Event domain for PNF registration with corresponding support in VES collector, DMaaP and PRH.
SO Workflow enhancements		Introduction of dedicated 5G use case work-flow
Service Configuration Improvement		Service configuration improvements from PNF Controller (APP-Cr, SDN-Cr) to PNF after PNF registration to PRH
Security Enhancements		Authentication, Certificates, User name & password and intra-ONAP security.
Modeling enhancements		Modeling enhancements to support 5G PNF in ONAP. Inheritance, and PNF characteristics for sharing. Focusing on PNF connectivity. PNF-SDK.
PNF Onboarding / Package		Defining <i>PNF Onboarding Package</i> . Extending framework to work with PNFs. Defining PNF Package framework.

PnP - ONAP Links

PAGE TOPIC	LINK
5G Use Cases	https://wiki.onap.org/display/DW/Use+case+proposal%3A+5G-+RAN+deployment%2C+Slicing%2C+SON
5G Functional Requirements Tracking	https://wiki.onap.org/display/DW/5G+Functional+Requirements+Tracking [R3 Requirements Main Page]
Casablanca Release Requirements	https://wiki.onap.org/display/DW/Casablanca+Release+Requirements [R3 M1 Milestone Commitments]
NFModeling-SDC_R324Jul2018v1	https://wiki.onap.org/display/DW/Casablanca
Plug and Play Use Case Wiki Page	https://wiki.onap.org/display/DW/5G+-+PNF+Plug+and+Play
A&AI Agenda (w/ PNF PnP items)	https://wiki.onap.org/display/DW/2018-08-08+AAI+Weekly+Meeting+Notes
Dublin Planning 5G	https://wiki.onap.org/pages/viewpage.action?pageId=38119661
DUBLIN Use Cases	https://wiki.onap.org/display/DW/Release+4+%28Dublin%29+Use+Cases
VNFRQTS-289	https://jira.onap.org/browse/VNFRQTS-289
Gerrit	https://gerrit.onap.org
ONAP Docs	https://onap.readthedocs.io/en/latest/submodules/vnfrqts/requirements.git/docs/Chapter7/index.html

PRH Enhancements

DESCRIPTION

PNF Registration Handler (PRH) Enhancements.

(1) New VES Event domain for PNF Registration –

Create new VES event domain for PNF registration with corresponding support in VES collector, DMaaP and PRH. In Beijing the PnP Use case used the “*other*” domain to register VES events. For Casablanca, we propose using a dedicated domain “*pnfRegistration*”. New DMaaP topic corresponding to new domain.

(2) VES EXTENSIONS - As a result, VES collector and VES agent content will change with field updates using the new domain. Extensions for pnfRegistration fields. Corresponding VES Schema change.

(3) DU SIMULATOR UPDATE – The registration VES event used by the DU Simulator (or actual PNF) will need to update its JSON payload to match the changes above.

(4) PRH & AAF INTEGRATION – PRH needs to interface to AAF for Intra-ONAP security. PRH needs to use certificates and tokens for authentication to be allowed to exchange events. PRH needs this authorization to publish to DMaaP topics.

(5) REVIEW LIBRARIES – comply to Linux foundation requirement for licensing & security vulnerabilities. Risk estimation.

(6) DEMO – Demo of PRH w/ PNF PnP in 5G Use Case



PROJECTS

PNF Registration Handler, DMaaP, DCAE

PNF PnP: SO Workflow Enhancements

DESCRIPTION

- (1) SO WORKFLOW ENHANCEMENTS** – Dedicated 5G BTS Workflow in SO. (If not model-driven would need special 5G BTS workflow)
- (2) PNF WORKFLOW** – Extensions to Beijing SO Workflow (part of VCPE workflow). Developed in Beijing not tested or integrated.
- (3) MODEL DRIVEN** – SO not yet model driven. Need to solve vis-à-vis a SO work flow specific to service & resource use case.
- (4) UPDATE PNF WORKFLOW** – needs to be officially tested, accepted (in Casablanca).
- (5) PNF Controller TO SO INTERACTION** –SO calls PNF Controller (SDN-R, Generic API call vs REST call)
- (6) DFX (Design for Excellence)** – Resilience, Performance, Scalability, Stability, Multi-site.

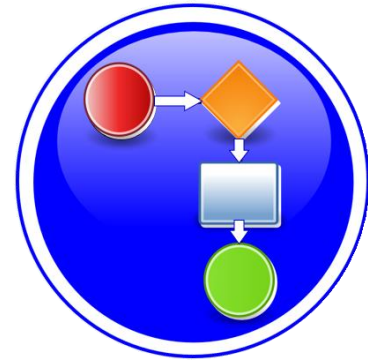

PROJECTS

SO

SERVICE CONFIGURATION ENHANCEMENT

DESCRIPTION

- (1) Service configuration Enhancements** to ONAP Controller to PNF *service configuration* exchange with PNF.
- (2) PROTOCOL DEFINITION** – Better definition around the Protocols supported (and/or support more protocols). What ONAP controller supports what PNF and what protocols are supported. NetConf, Ansible, Chef.
- (3) Configuration Extensions** – New parameters needed for Casablanca use cases. Vid script to pushing data, ID config, ID where data comes from. Generic configuration support.
- (4) PNF PnP Config** – Finishing PNF PnP by sending down config data.
- (5) (OPTIONAL) Vendor Data** – Extensions to Service Configuration with Vendor specific configuration data can be developed (vendor dependent).



PROJECTS

ONAP Controller (SDN-R), VID, SO,
SDC/CDT

SECURITY ENHANCEMENTS

DESCRIPTION

- (1) PNF AUTHENTICATION** – DCAE must authenticate the HTTP/TLS connection from the PNF. DCAE to integrate the HTTP and TLS authentication functionality by AAF.
- (2) VENDOR CERTIFICATES** – Handling Vendor Certificates for TLS/SSH for PNFs.
- (3) USER NAME & PASSWORDS** – Provisioning. DCAE & PNF management of *User Name & Passwords*.
- (4) SECURITY BETWEEN COMPONENTS** – DMaaP & PRH to authenticate w/ other ONAP components.



PROJECTS

PNF Registration Handler, DCAE, AAF,
ONAP Controller, DMaaP

PNF PnP: MODELING ENHANCEMENTS

DESCRIPTION

- (1) PNF MODELING** – Modeling enhancements to support 5G PNF in ONAP. Model Inheritance definitions for PNF. SDC modeling improvements from Beijing PnP use case.
- (2) PNF SHARING** – SDC model updates for PNF characteristics focusing on PNF inter-connectivity.
- (3) PNF-SDK** – SDK provided from Vendors. This will help modeling the Physical “Box” (PNF) and network functions.
- (4) CDT ENHANCEMENTS** - Improving CDT to handle complex config templates, multiple templates per PNF, identify different sources for template data, integrating CDT into SDC, expanding CDT usage to other controllers.



PROJECTS

SDC, CDT

PNF ONBOARDING / PNF PACKAGE

DESCRIPTION

PNF Onboarding and PNF Package

(1) PNF PACKAGE DEFINITION – Defining *PNF Onboarding Package*. Extending framework to work with PNFs. Defining PNF Package framework.

- A. **PNF ARTIFACTS DEFINITION** – Vendor specific/provided artifacts to add to the (new PNF) package.
- B. **PNF ARTIFACTS DISTRIBUTION**



PROJECTS:
SDC, APP-C



PNF Plug and Play IN CASABLANCA (R3)

- ONAP and PNF Plug and Play for 5G RAN
- 5G Use Case Team

PNF Plug and Play Stages

Design Time

①



PNF Modeling

Resources Definition/Services Definition
SDC: PNF (physical element) Modeling
Distribution of types



②



PNF Instance Declaration

PNF Infrastructure Service Declaration

First part of PNF instantiation

DCAE & AAI Entry with PNF ID (e.g. MAC address)

⑮ ⑯ ⑰ ⑱ ⑲ ⑳ ㉑ ㉒



③

PNF Boot-strapping



PNF Powers up and Boot-straps
PNF performs a "Plug and Play" procedure

Equipment vendor proprietary steps

④



PNF Contacts ONAP

PNF connects to ONAP via a Registration Event
PNF Registration Handler (PRH) processes the event

㉓ ㉔ ㉕ ㉖ ㉗ ㉘ ㉙ ㉚

Run-Time (Instances)

⑤



PNF Activation

Connection points configured

Second part of PNF service instantiation

PNF configured and ready to provide service

㉛ ㉜ ㉝ ㉞ ㉟ ㊱ ㊲ ㊳

ACTORS	DESCRIPTION
PNF	PHYSICAL NETWORK FUNCTION (PNF) – A Network Function that is hosted on a physical hardware device, not in the cloud infrastructure.
DHCP	DYNAMIC HOST CONFIGURATION PROTOCOL (DHCP) – Protocol to assign IP addresses to a network element (NE). The IP address can be dynamically assigned or static based on MAC address of PNF.
SEGW	SECURITY GATEWAY – Used to set up IPSec tunnels to protect against unsecured traffic entering an internal network of an operator; used by enterprises to protect their users from accessing and being infected by malicious traffic.
CA/RA	CERTIFICATE AUTHORITY / REGISTRATION AUTHORITY – Used to generate a service provider certificate for the PNF.
Initial EM	INITIAL EM – Provides basic configuration and software download services to the PNF. This might be a equipment vendor specific solution. Also, responsible for identifying a PNF.
SDN-C	SOFTWARE DEFINED NETWORK CONTROLLER (SDN-C) – A controller for Layer 0 to 3 devices. Manages transport and network connections.
DCA&E	DATA COLLECTION, ANALYTICS AND EVENTS (DCAE) – Gathers performance, usage, and configuration data from the managed environment. Collect, store data and provides a basis for analytics within ONAP. For PNF Plug and Play can potentially perform analytics on the Plug and Play process, statistics, logs.
A&AI	ACTIVE & AVAILABLE INVENTORY – The PNF is identified as available inventory and tracked through a key which is the PNF ID. When onboarded the PNF gets an entry in A&AI and can then be tracked, requested, and seen by the ONAP components for service requests or other queries.
SO	SERVICE ORCHESTRATOR – Serves as a mediator and coordinator of service requests.
APP-C	APPLICATION CONTROLLER (APP-C) - A controller for Layer 4 to 7 applications. Manages the life cycle of virtual applications, virtual network functions (VNFs), and components. APP-C manages the 5G DU & 4G DU.
PNF Registration Handler	PNF Infrastructure Manager – A microservice in DCAE used during PNF Plug-n-Play to process the PNF Registration event.

Design Time (ONAP)

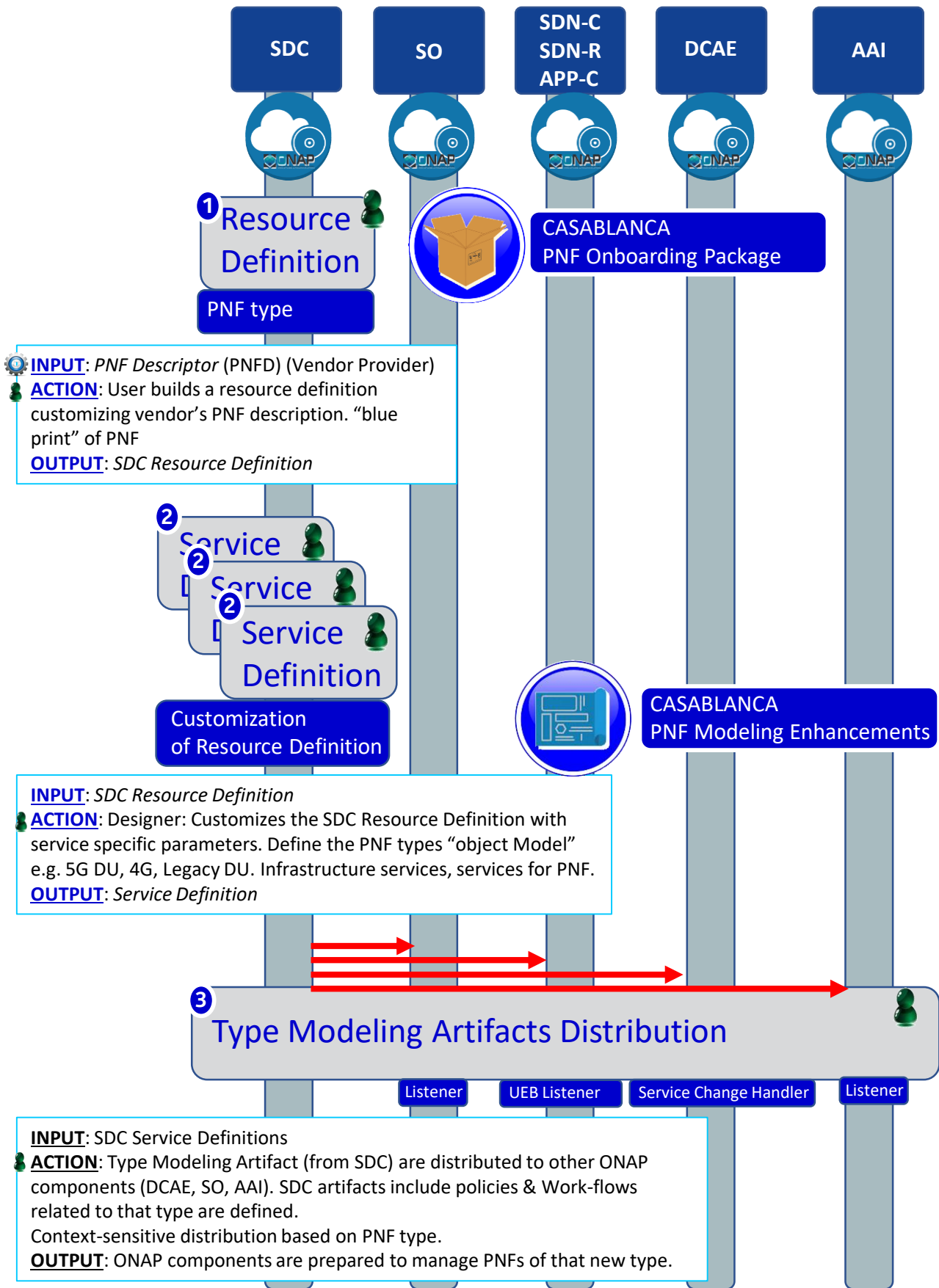

PNF PnP: MODELING ENHANCEMENTS

DESCRIPTION

- (1) PNF MODELING** – Modeling enhancements to support 5G PNF in ONAP. Model Inheritance definitions for PNF. SDC modeling improvements from Beijing PnP use case.
- (2) PNF SHARING** – SDC model updates for PNF characteristics focusing on PNF inter-connectivity. DCAE-DS Micro-service modeling.
- (3) PNF-SDK** – SDK provided from Vendors. This will help modeling the Physical “Box” (PNF) and network functions.
- (4) CDT ENHANCEMENTS** - Improving CDT to handle complex config templates, multiple templates per PNF, identify different sources for template data, integrating CDT into SDC, expanding CDT usage to other controllers.



PROJECTS

SDC, CDT

PNF ONBOARDING / PNF PACKAGE

DESCRIPTION

PNF Onboarding and PNF Package

(1) PNF PACKAGE DEFINITION – Defining *PNF Onboarding Package*. Extending framework to work with PNFs. Defining Package framework.

- A. **PNF ARTIFACTS DEFINITION** – Vendor specific/provided artifacts to add to the (new PNF) package.
- B. **PNF ARTIFACTS DISTRIBUTION**

TOSCA Meta data - main service template, TOSCA template.

Artifact Package. Separated by types of artifacts. Separations by folder for different types. Place artifacts in categories. Anyone can choose which artifacts to receive.

Definitions – Specifies definitions such as CM, FM and PM definitions

(1) Protocols Supported – PNF package. CM Protocol is in PNF onboarding package. (Chef, Ansible, NetConf)

(2) Controller – What is the PNF controller



PROJECTS:

SDC, APP-C

STEP	DESCRIPTION
1	<p>RESOURCE DECLARATION – A user on the VID performs a Resource Declaration. This uses the Service definition created in SDC. The user on the VID can define known information about the PNF. The user can (optional) provide the following information</p> <p>PNF RESOURCE Definition</p> <ul style="list-style-type: none"> Resource Type – Type of Resource. NEW type: PNF (pre-defined in SDC) NAME – Name of the PNF type CATEGORY – e.g. Infrastructure TAGS – User-definable tags (default name of the PNF) DESCRIPTION – Textual description CONTACT ID – Designer (user of ONAP) VENDOR – PNF Vendor (e.g. Nokia) VENDOR RELEASE – Vendor release VENDOR MODEL NUMBER – PNF Model value (link to A&AI) EVENTS – Monitoring Event definitions. Define design-time templates. CLAMP (runtime monitoring), DCAD (design time design template attach to VNF). Define templates & attach them. <p>Note: The user may provide whatever information in the above fields they know. Note: Consumer vs Enterprise deployments. Consumer systems pre-registered, distributed throughout a region. For a consumer deployment you might not know the MAC address/Serial number (PND IF) until the PNF connects to ONAP.</p>
2	<p>SERVICE Definition (uses a PNF)</p> <ul style="list-style-type: none"> NAME – Name of the Service (mandatory) CATEGORY – e.g. Network L1...L4, VOIP call Control, Mobility TAGS – User-definable tags (default name of the PNF) DESCRIPTION – Textual description of service (mandatory) CONTACT ID – Designer (user of ONAP) (mandatory) PROJECT CODE – ID (mandatory) Ecomp-Generated Naming – Name Naming Policy – Policy to be used to assign a name to a service by SO/SDNC SERVICE TYPE – Type of service SERVICE ROLE – The Role of this service. ENVIRONMENTAL CONTEXT – distributed environments Specific Service(?) – PNF, allotted resource from a CU Service <p>The “basic” model are extended. Inherit (OO) from existing model. Vendor takes standard node types and creates their own extension. CDT (Configuration Design Tool) (GUI) to build artifacts to be used by APP-C (Tosca models) for a configure Template.</p>
3	<p>DISTRIBUTION – Event Monitoring Templates distributed. (?)</p>

Deployment Handler (VES Collector)

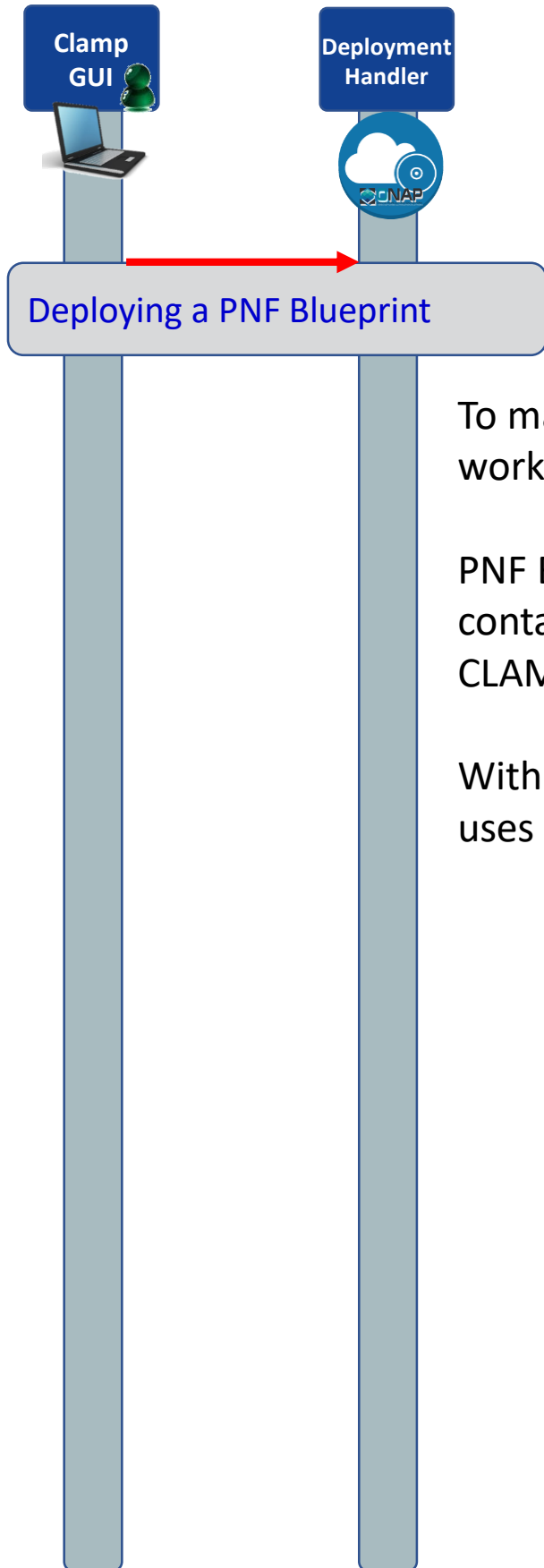

To make a VES Collector in DCAE work properly

PNF Blueprint will be docker container. May be deployed from CLAMP or Cloudify Orchestrator.

Within VES Collector schema uses “Adder” (existing)

STEP	DESCRIPTION
1	<p>DEPLOYMENT HANDLER PNF BLUEPRINT – The Deployment handler is necessary to use, to give it the PNF blueprint so that later on in the Plug and Play flow, DCAE will recognize the PNF. The PNF Blueprint will be docker container. The PNF blueprint May be deployed from CLAMP or Cloudify Orchestrator to DCAE. Within VES Collector schema uses “Adder” (existing).</p>

PNF Resource Declaration

BSS Portals
VID
AAI UI



AAI



OPT

4

Resource Declaration & Create A&AI PNF Entry



A&AI entry of Inactive PNF, PNF Type Resource Declaration



Inactive PNF
A&AI entry

Steps 15-22 accomplishes this purpose but service providers can choose to implement this flow to augment (e.g. service providers inventory management system)

STEP	DESCRIPTION
4	<p>RESOURCE DECLARATION – A user on the VID performs a Resource Declaration. This uses the Service definition created in SDC. The user on the VID can define known information about the PNF. The user can (optional) provide the following information</p> <p>PNF RESOURCE Definition</p> <ul style="list-style-type: none"> Resource Type – Type of Resource. NEW type: PNF (pre-defined in SDC) NAME – Name of the PNF type CATEGORY – e.g. Infrastructure TAGS – User-definable tags (default name of the PNF) DESCRIPTION – Textual description CONTACT ID – Designer (user of ONAP) VENDOR – PNF Vendor (e.g. Nokia) VENDOR RELEASE – Vendor release VENDOR MODEL NUMBER – PNF Model value (link to A&AI) EVENTS – Monitoring Event definitions. Define design-time templates. . <p>The PNF entry in AAI is created by the PRH with the PNF ID (or correlation ID) address. After this step, the PNF is considered to be created but inactive within ONAP. It can then be later used in the second part of service instantiation. See Step 28.</p> <p>(OPTIONAL) IP address of PNF may be set during this step</p>

PNF Plug and Play Component Interaction

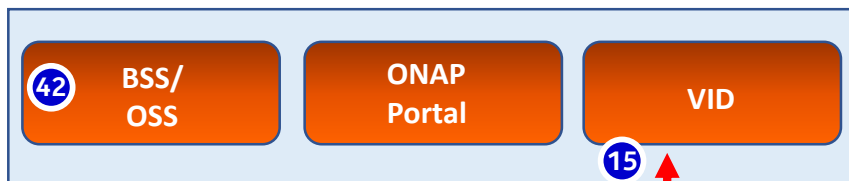



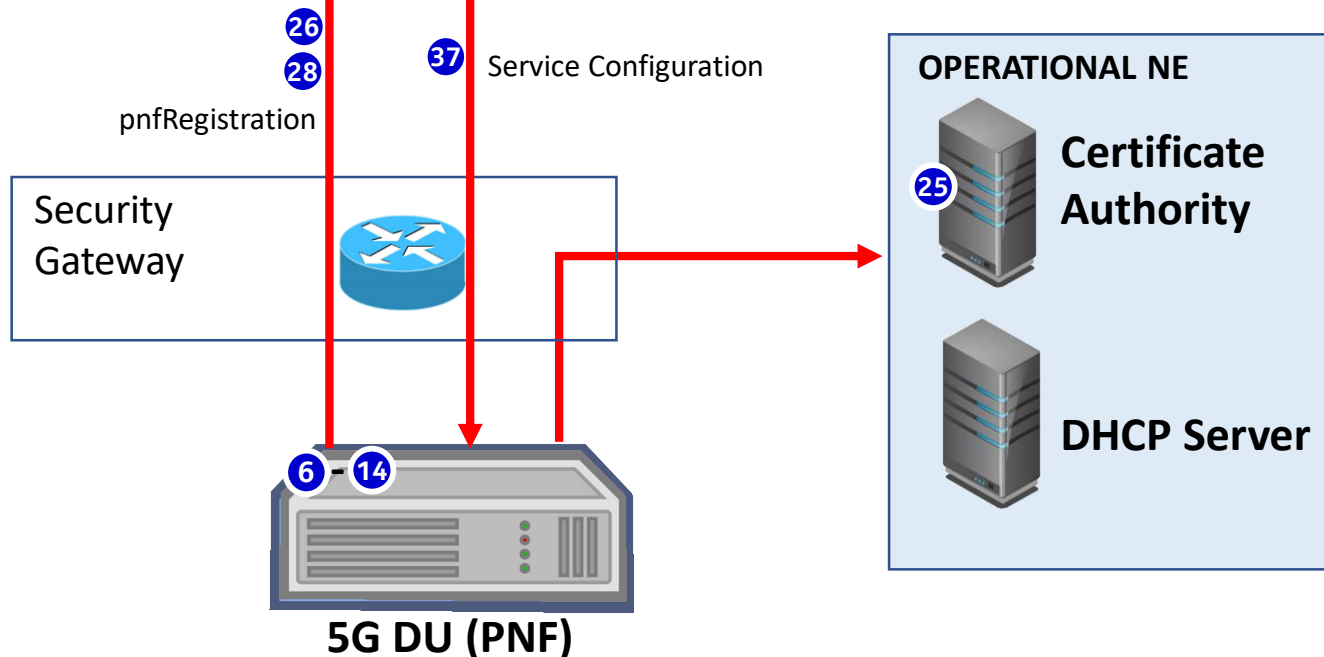
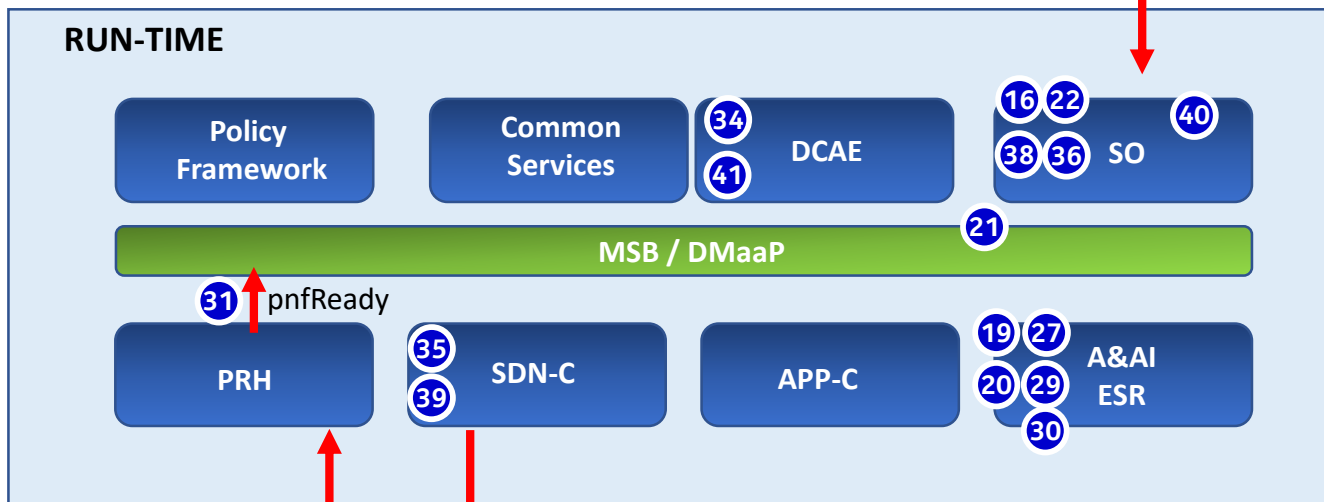
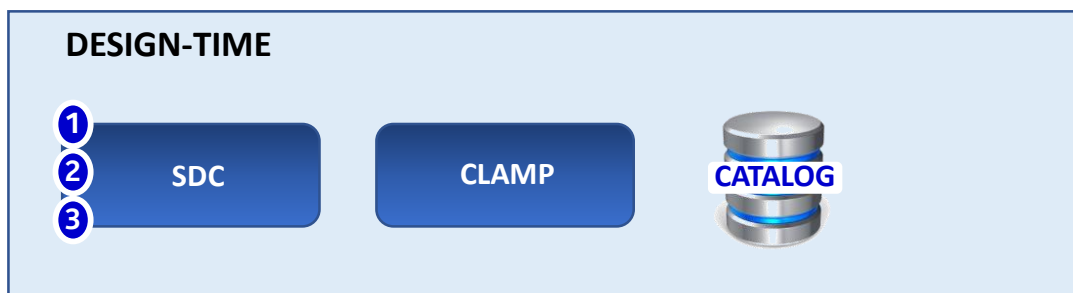



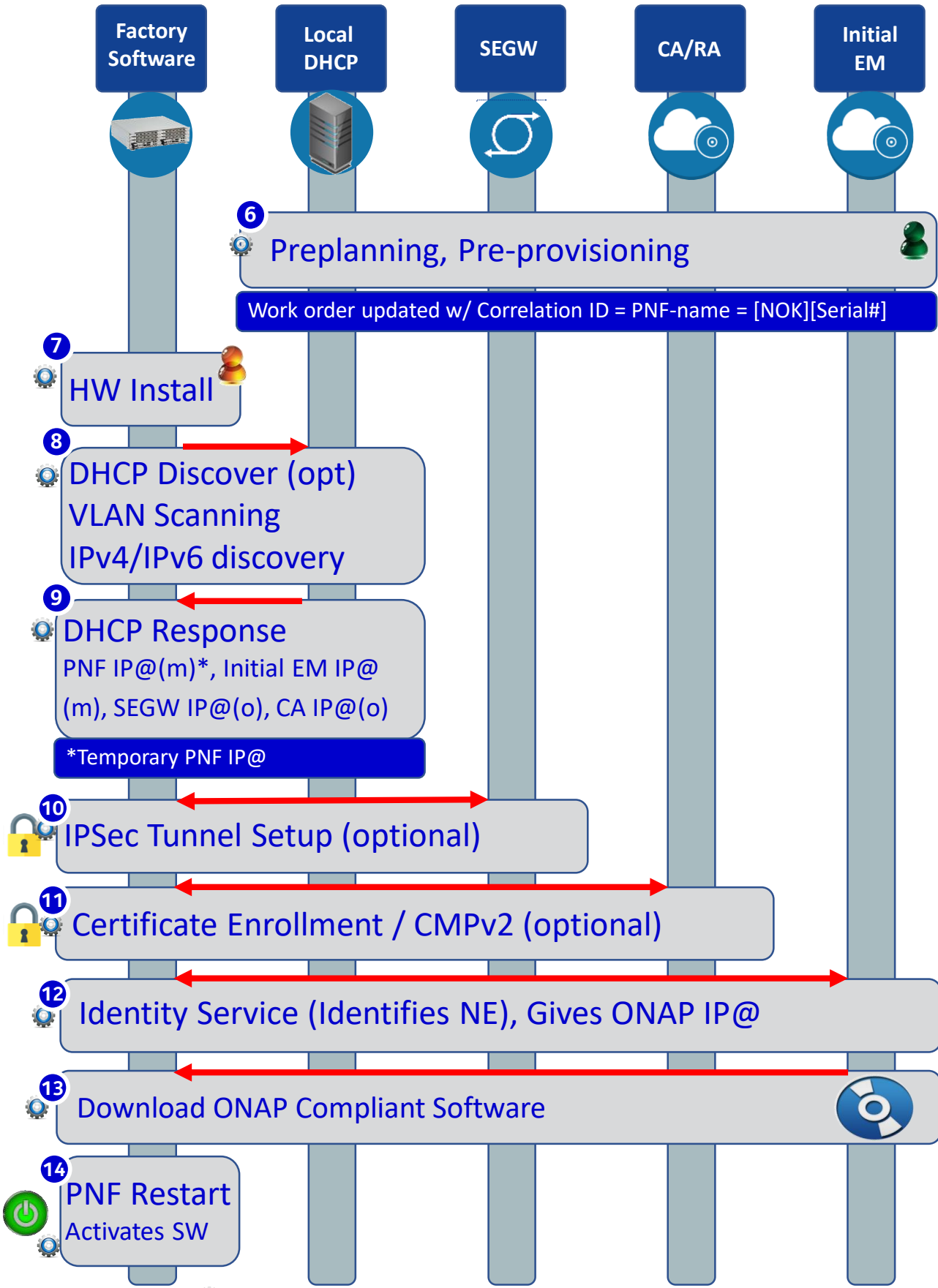

ONAP Deployment









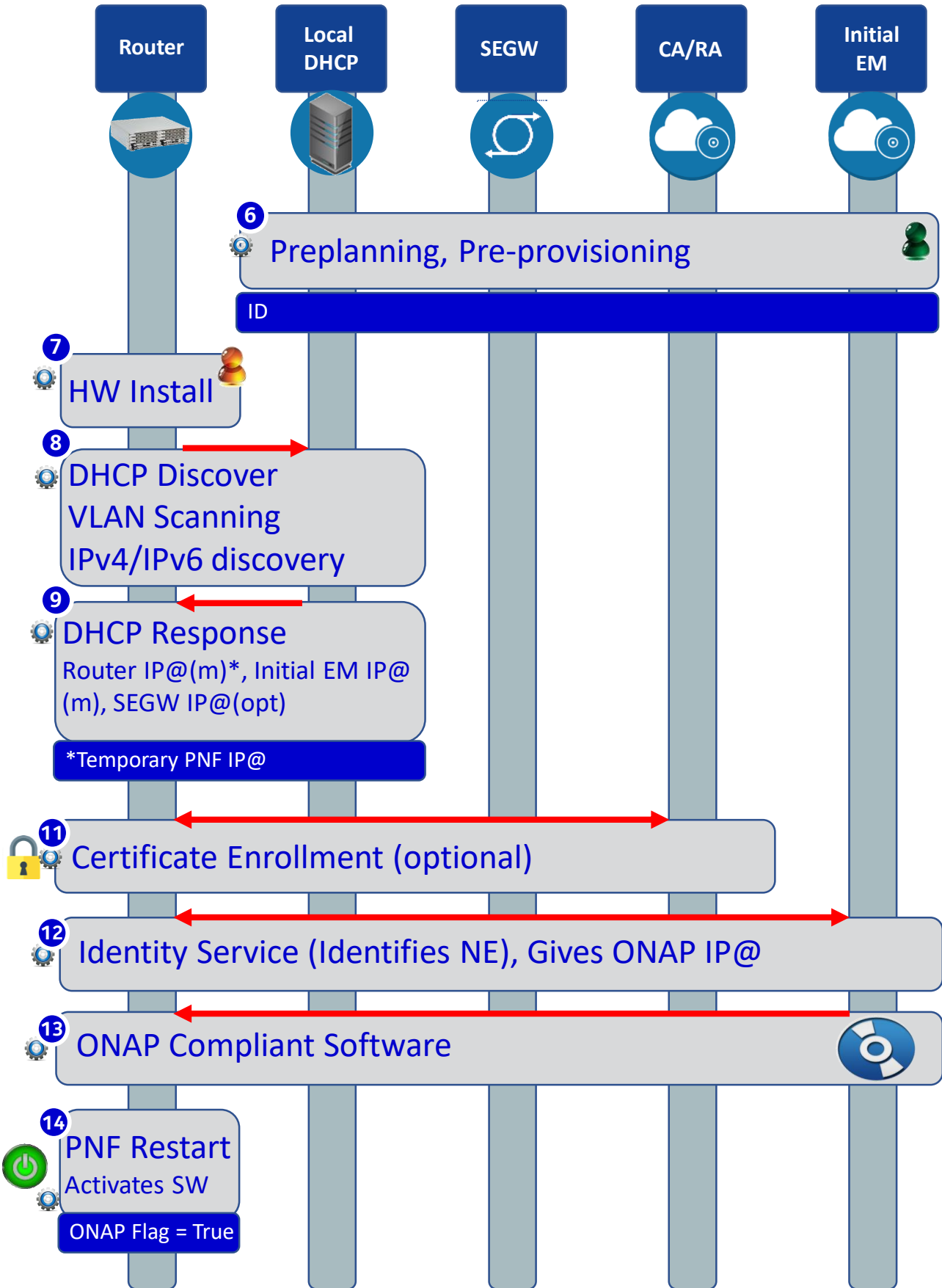

Stage 3: PNF Plug and Play Steps (for 5G DU)



STEP	DESCRIPTION (Plug and Play Vendor steps for Infrastructure components)
6 	<p>PRE-PLANNING, PRE-PROVISIONING – There is data which is programmed into the system for the PNF Plug and Play operation. The user programs the local DHCP IP address(@), the Security Gateway IP@, the CA/RA certificate information, the management plane IP address (the ONAP IP@), the software service IP@ for use by the PNF during the onboarding process.</p> <p>Note: <i>The CU is instantiated ahead of time with the expected DUs that it should be connected to (that is outside the scope of this flow).</i></p> <p>Note: The user name & password which the PNF needs to know to contact and get through the vAAA server before it contacts ONAP.</p>
7 	<p>HW INSTALL – The physical hardware is installed at the site. Site licensing, real estate contacts, zoning, and physical hardware of the PNF is installed by technicians. Power, backhaul, and antennas are installed and connected.</p>
8 	<p>INITIAL NETWORK ACCESS – A DHCP Discover procedure is executed when the PNF powers on, VLAN Scanning is performed, and IPv4/IPv6 discovery is done. The DHCP Discover message exchange provides an entryway into the network and is designed as an procedure for a network element to be able to find connection to the network from “scratch”. VLAN Scanning and IPv4 vs IPv6 discovery is done as well.</p>
9 	<p>DHCP RESPONSE – The DHCP response returns a PNF IP address, the initial EM IP address, Security Gateway IP address (optional), and certificate authority IP address (opt). It is possible the PNF IP address is a temporary IP address used for initial connectivity purposes, and that a permanent PNF IP address will be granted later.</p>
10 	<p>IPSEC TUNNEL – An IP Sec Tunnel is established which uses cryptography to provides a secure connection. IPSec has two security services: Authentication header and an encapsulating security payload with tunnel and transport modes.</p>
11 	<p>CERTIFICATE ENROLLMENT – The process where the PNF gets a service provider certificate from the Certificate authority. The certificate is then used to authenticate and verify the PNF.</p>
12 	<p>IDENTITY SERVICE – The identity service is there to identify the PNF. It also returns the ONAP (DCAE) IP address.</p>
13 	<p>ONAP COMPLIANT SOFTWARE – The PNF contacts the initial EM and downloads the ONAP Bootstrap software. This is a software package that is meant to perform the remaining steps of PNF registration and activation onto ONAP</p>
14 	<p>PNF RESET – The PNF is reset so that the downloaded ONAP Bootstrap software becomes activated and is then ready to continue to PNF registration</p>

PNF Bootstrapping Steps (for Routers)



STEP	DESCRIPTION (Plug and Play Vendor steps for Infrastructure components)
6 	<p>PRE-PLANNING, PRE-PROVISIONING – There is data which is programmed into the system for the PNF Plug and Play operation. The user programs the local DHCP IP address(@), the Security Gateway IP@, the CA/RA certificate information, the management plane IP address (the ONAP IP@), the software service IP@ for use by the PNF during the onboarding process.</p> <p>Note: <i>The CU is instantiated ahead of time with the expected DUs that it should be connected to (that is outside the scope of this flow).</i></p> <p>Note: The user name & password which the PNF needs to know to contact and get through the vAAA server before it contacts ONAP.</p>
7 	<p>HW INSTALL – The physical hardware is installed at the site. Site licensing, real estate contacts, zoning, and physical hardware of the PNF is installed by technicians. Power, backhaul, and antennas are installed and connected.</p>
8 	<p>INITIAL NETWORK ACCESS – A DHCP Discover procedure is executed when the PNF powers on, VLAN Scanning is performed, and IPv4/IPv6 discovery is done. The DHCP Discover message exchange provides an entryway into the network and is designed as an procedure for a network element to be able to find connection to the network from “scratch”. VLAN Scanning and IPv4 vs IPv6 discovery is done as well.</p>
9 	<p>DHCP RESPONSE – The DHCP response returns a PNF IP address, the initial EM IP address, Security Gateway IP address (optional), and certificate authority IP address (opt). It is possible the PNF IP address is a temporary IP address used for initial connectivity purposes, and that a permanent PNF IP address will be granted later.</p>
11 	<p>CERTIFICATE ENROLLMENT – The process where the PNF gets a service provider certificate from the Certificate authority. The certificate is then used to authenticate and verify the PNF.</p>
12 	<p>IDENTITY SERVICE – The identity service is there to identify the PNF. It also returns the ONAP (DCAE) IP address.</p>
13 	<p>ONAP COMPLIANT SOFTWARE – The PNF contacts the initial EM and downloads the ONAP Bootstrap software. This is a software package that is meant to perform the remaining steps of PNF registration and activation onto ONAP</p>
14 	<p>PNF RESET – The PNF is reset so that the downloaded ONAP Bootstrap software becomes activated and is then ready to continue to PNF registration</p>

Stage 2: Service Instantiation Process

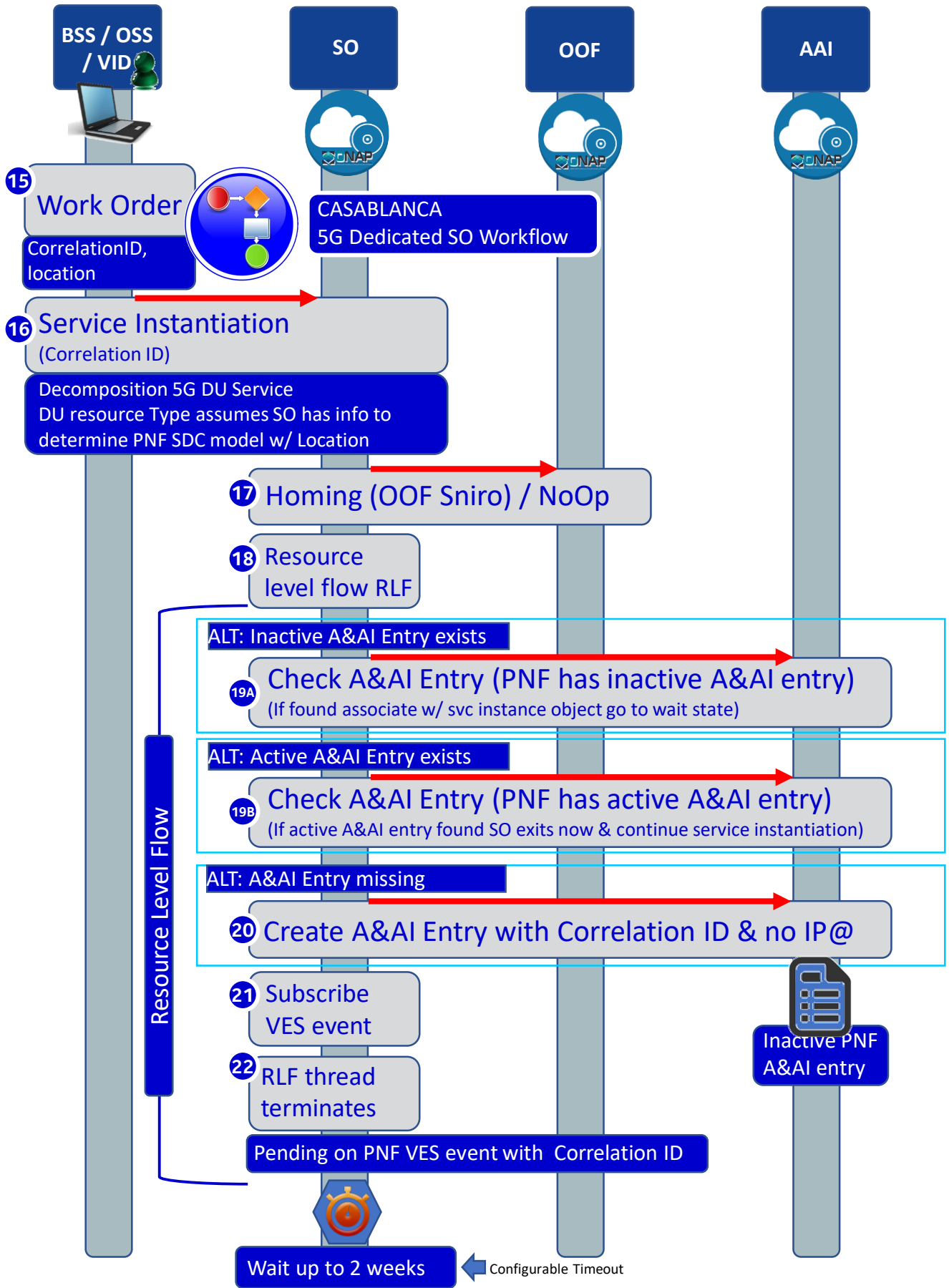

PNF PnP: SO Enhancements

DESCRIPTION

- (1) PNF WORKFLOW** – Coded in Beijing but needs yet to be integrated, tested, and accepted. Note: One PNF workflow (SO) that has two entry points: (1) instantiate & wait (Step 16) (2) Update (Step 34). One BPMN.
- (2) SO TO PNF Controller INTERACTION** – SO calls SDN-R (Generic API call vs REST call (?)). How should SO recognize which controller to use. List of operations.
- (3) PNF WORKFLOW ENHANCEMENTS** – Investigate the use of a Generic PNF workflow (will it work for 5G PNF). Investigate if enhancements (customizations) are needed to the PNF Workflow.
- (4) MODEL DRIVEN** – SO not yet model driven. Need to solve vis-à-vis a SO work flow specific to service & resource use case. *Controller type* to be used w/ PNF should be modeled in SDC.
- (5) DFX (Design for Excellence)** – Resilience, Performance, Scalability, Stability, Multi-tenants (multi-tenants access). Multi-site (single instances of SO).

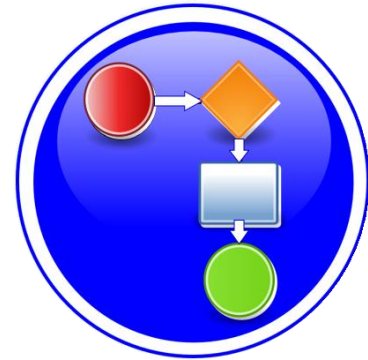

PROJECTS

SO, SDN-R, SDC, AAI

#	DESCRIPTION
15	WORK ORDER – The work order (AT&T work order process) determines which PNF to use for this Service/work order. BSS is told the correlation ID. Typically, the PNF will be known before the PNF comes on-line. Orchestrated with a equipment order (to vendor) and location value for the PNF.
16	SERVICE INSTANTIATION – The user on the VID creates a service instantiation providing a correlation ID. The service is decomposed for a 5G DU PNF. The DU resource types assumes that there is enough information to determine the PNF SDC model. The configuration parameter is provided manually (as part of service instantiation data).
17	HOMING – The SO instantiation is homed with the OOF. Dependencies stated on PNF. The homing latency constraints are based on CPE address (location). As part of the service definition a latency needs to be less than [x]. This is a service constraint. Homing dependencies should come from SDC or VID. PNF homes to a CU. [FUTURE] Homing identifies the place where a VNF is instantiated. For PNF there is no “cloud” resources needed (CU); ONAP instantiations/data-centers want to define which ONAP instantiation takes care of a PNF [FUTURE].
18	RESOURCE LEVEL FLOW (RLF) - The resource level flow thread starts. This thread is responsible for carrying out the creation of an A&AI entry in the following steps (steps 18 through 21).
19	CHECK A&AI ENTRY – The RLF thread in SO checks the A&AI entry for the PNF. If SO discovers that there is an A&AI entry with both the correlationID and the PNF IP@ then it can continue. If found it can associate it with the service instance.
20	CREATE A&AI ENTRY – A&AI entry created by SO for PNF using the available information and the correlation ID. This is done in anticipation of the PnP PNF VES event.
21	CREATE DMaaP TOPIC LISTENER – The RLF thread (process) subscribes to the DMaaP Topic that will complete the service instantiation. It allows ONAP to intercept the VES event that will eventually come from the PNF when it reaches a point in the PNF Plug and Play process that it is ready to contact ONAP. The RLF specific resource thread indicates that it cares about the VES event with this correlation ID. Essentially it activates a “listener” of the PNF VES event. DCAE is the normal VES event Listener which creates a DMaaP Topic. SO saves the state information looks and sees if it is one of the DMaaP topics it is waiting for.
22	RLF THREAD TERMINATES – The Resource Level Flow (RLF) thread in SO terminates. When the VES event is received at a later point in time, it can be processed accordingly. Additionally, these steps 15-22 prepare ONAP with the pre-requisite information so that when the VES event comes from the PNF it will not be discarded. This is denoted by stopwatch icon  . At a later step in the PNF Plug and Play this thread becomes relevant again at the other stopwatch icon. The RLF thread/process stops processing and wait for an asynchronous event (to avoid a long running event). Writes a process, kamunda handler for an event that rehydrates it. (this reuses the SO rainy day handling)

Stage 4: PNF Registration Steps

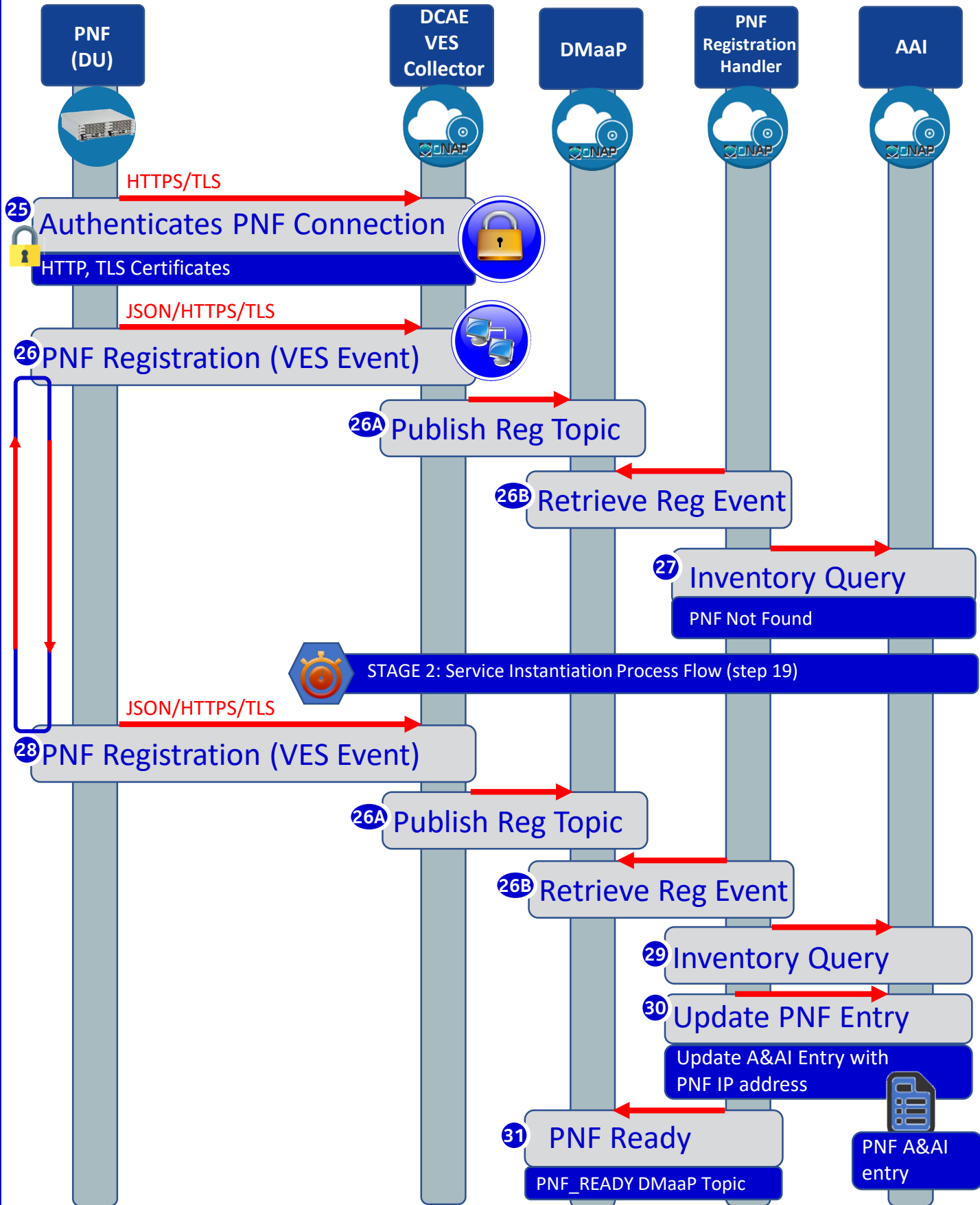

Re-registration PnP Use Case

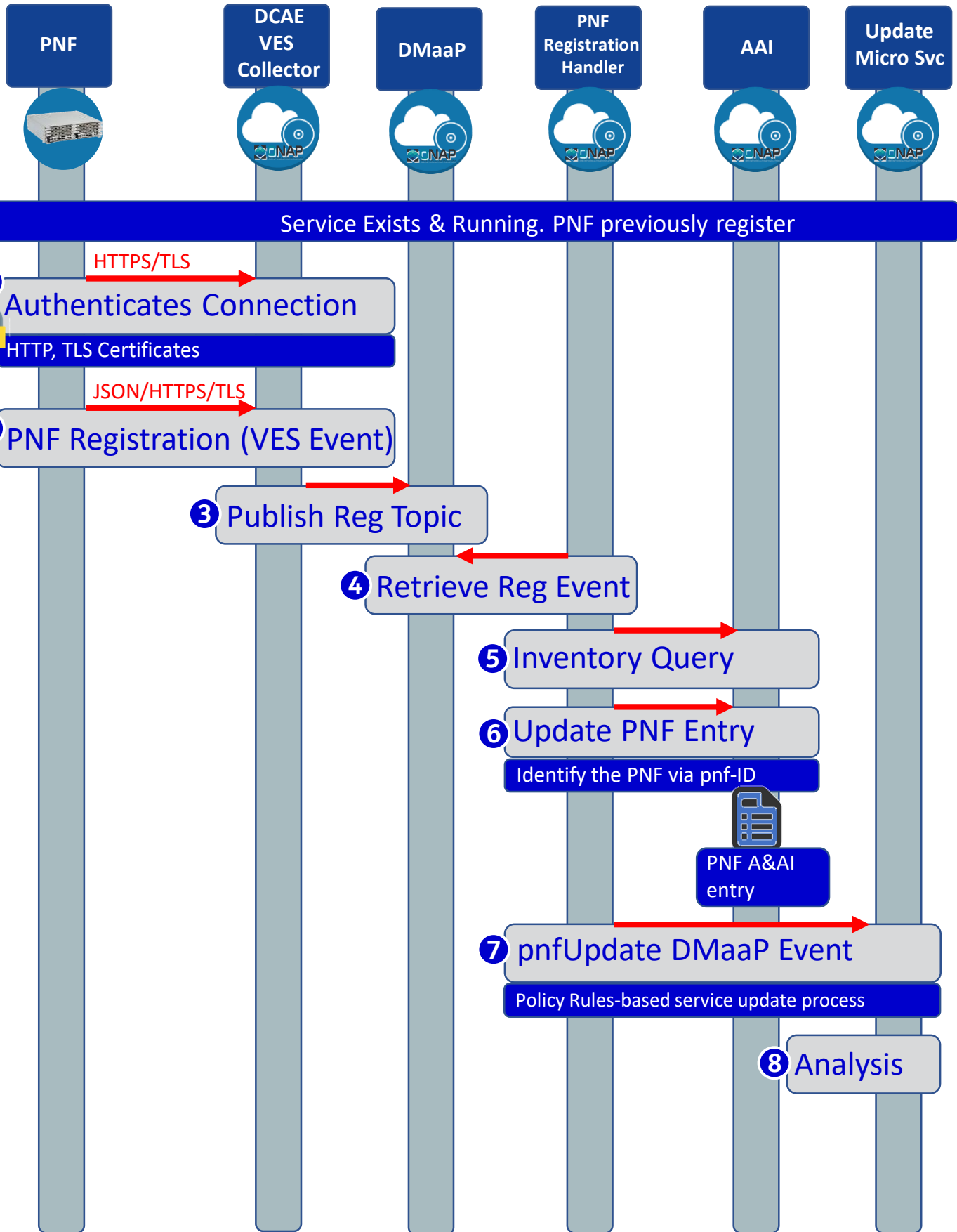

PNF Re-Registration Use Case (continued)

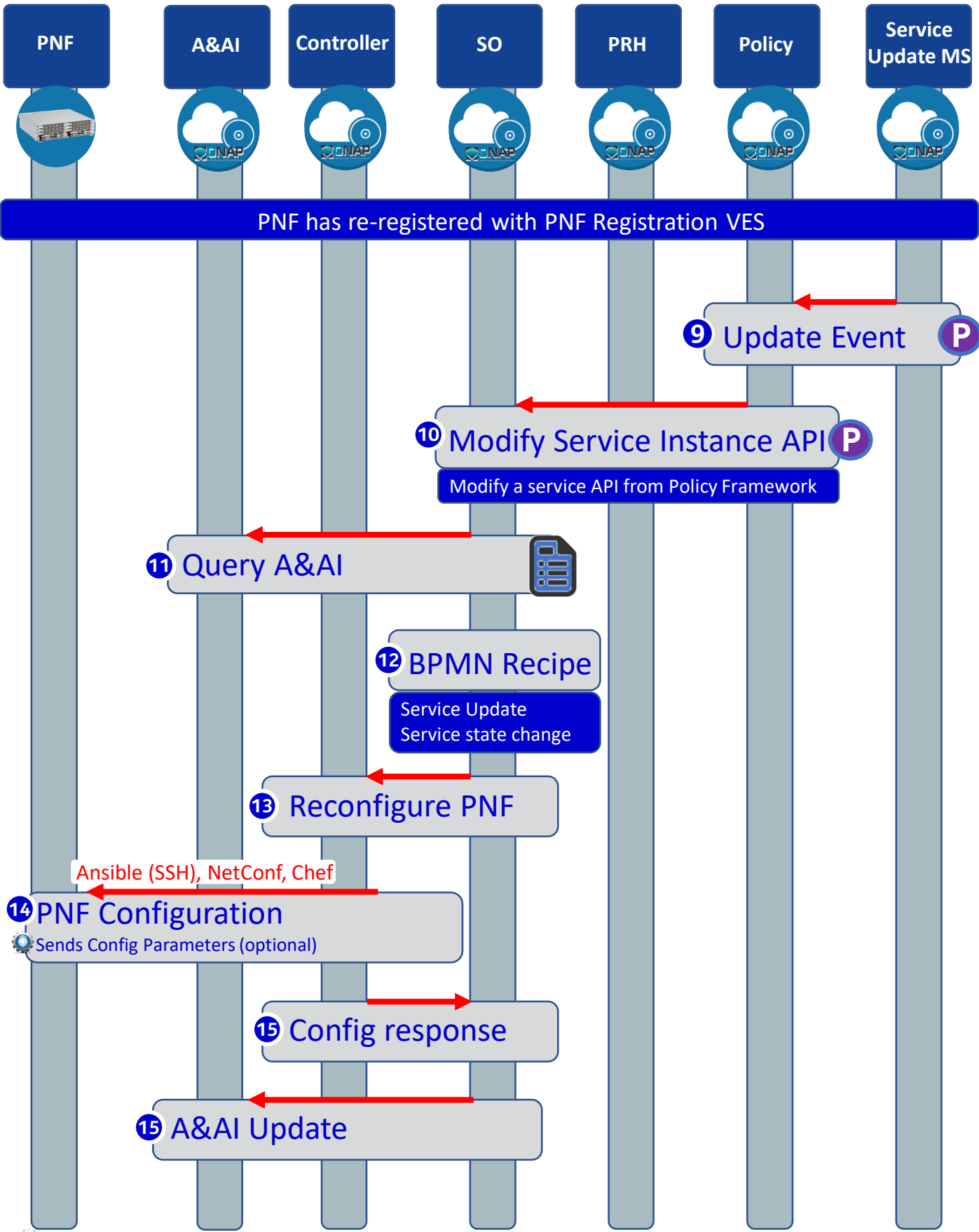

PNF Re-Registration Use Case

Rehoming

The PNF is rehomed to a different ONAP instance or a different manager

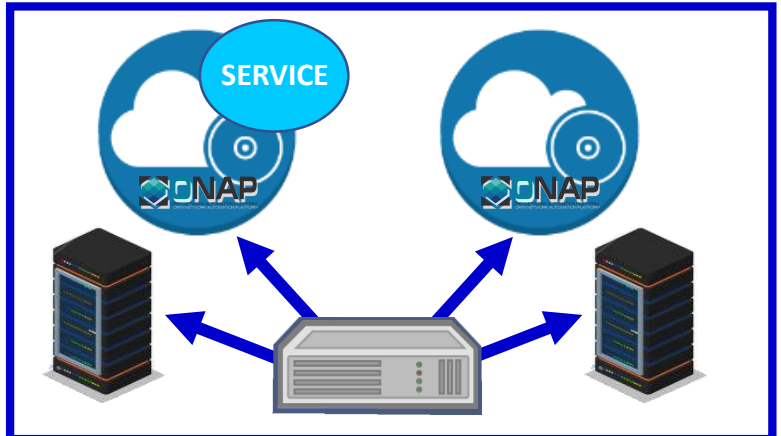

Disconnection / Reconnection

The PNF is disconnected and reconnected a period of time later.

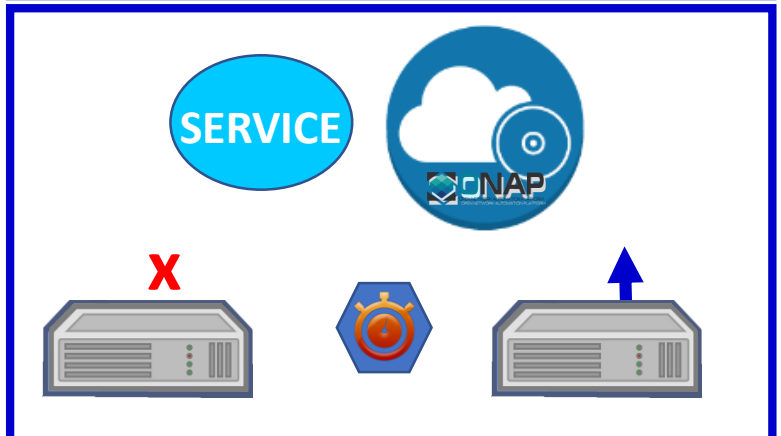

Physical Relocation

The Physical relocation of the PNF, for example of one side of the city to another.

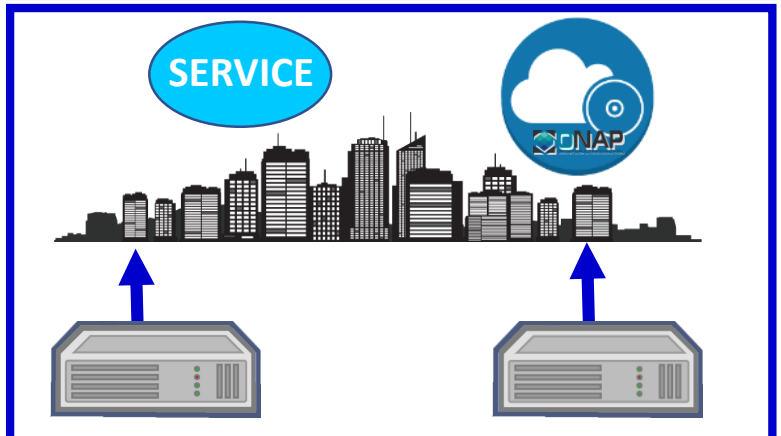

Service Management

The Service associated with a PNF needs to be updated.

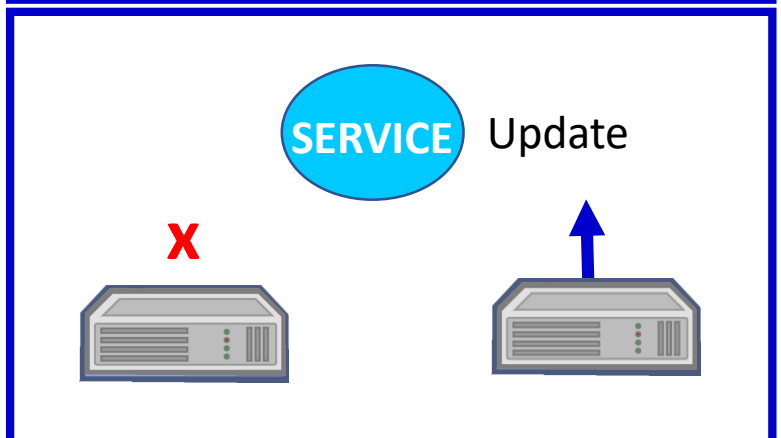

pnfRegistration VES Event

Field	Type	Required?	Description
version	number	Yes	Version of the event header (currently: 3.0) 3.0
eventName	string	Yes	pnfRegistration_vendor_pnfName where pnfName is specified by the vendor and is a PNF type; e.g. pnfRegistration_Nokia_5gDu
domain	string	Yes	Event domain enumeration: 'fault', 'heartbeat', 'measurementsForVfScaling', 'mobileFlow', 'other', 'sipSignaling', 'stateChange', 'syslog', 'thresholdCrossingAlert', 'voiceQuality', 'pnfRegistration'
eventId	string	Yes	Event key that is unique to the event source registration_yyyyyyyy where yyyyyyyy is an integer starting at 0 and incremented by 1 for every pnfRegistration event sent by this PNF
eventType	string	No	pnfRegistration
nfcNamingCode	string	No	Network function component type: 3 characters (aligned with vfc naming standards) Not used
nfNamingCode	string	No	Network function type: 4 characters (aligned with vnf naming standards) Not used
sourceId	string	No	UUID identifying the entity experiencing the event issue (note: the AT&T internal enrichment process shall ensure that this field is populated) Not used
sourceName	string	Yes	Name of the entity experiencing the event issue PNFid (unique PNF instance ID = PNF correlation ID = pnf-name stored in AAI ; e.g. NOK6061ZW3)
reportingEntityId	string	No	UUID identifying the entity reporting the event, for example an OAM VM (note: the AT&T internal enrichment process shall ensure that this field is populated) Not used
reportingEntityName	string	Yes	Name of the entity reporting the event, for example, an EMS name. May be the same as the sourceName. For synthetic events generated by DCAE, it is the name of the app generating the event. PNFid (unique PNF instance ID = PNF correlation ID = pnf-name stored in AAI ; e.g. NOK6061ZW3)
priority	string	Yes	Processing priority enumeration: 'High', 'Medium', 'Normal', 'Low' Normal
startEpochMicrosec	number	Yes	the earliest unix time aka epoch time associated with the event from any component--as microseconds elapsed since 1 Jan 1970 not including leap seconds current time
lastEpochMicrosec	number	Yes	the latest unix time aka epoch time associated with the event from any component--as microseconds elapsed since 1 Jan 1970 not including leap seconds current time
sequence	integer	Yes	Ordering of events communicated by an event source instance (or 0 if not needed) 0
internalHeaderFields	internalHeaderFields	No	Fields (not supplied by event sources) that the VES Event Listener service can use to enrich the event if needed for efficient internal processing. This is an empty object which is intended to be defined separately by each provider implementing the VES Event Listener. Empty Not used

pnfRegistration VES Event

Field	Type	Required?	Description
pnfRegistrationFieldsVersion	number	Yes	Version of the pnfRegistrationFields block (currently: 1.0)
serialNumber	string	Yes	TS 32.692 serialNumber = serial number of the unit; e.g. 6061ZW3
vendorName	string	Yes	TS 32.692 vendorName = name of manufacturer; e.g. Nokia. Maps to AAI equip-vendor.
oamV4IpAddress	string	No ¹	IPv4 m-plane IP address to be used by the manager to contact the PNF. Maps to AAI ipaddress-v4-oam.
oamV6IpAddress	string	No ¹	IPv6 m-plane IP address to be used by the manager to contact the PNF. Maps to AAI ipaddress-v6-oam.
macAddress	string	No	MAC address of unit.
unitFamily	string	No	TS 32.692 vendorUnitFamilyType = general type of HW unit; e.g. BBU.
unitType	string	No	TS 32.692 vendorUnitTypeNumber = vendor name for the unit; e.g. Airscale. Maps to AAI equip-type.
modelName	string	No	TS 32.692 versionNumber = version of the unit from vendor; e.g. AJ02. Maps to AAI equip-model.
softwareVersion	string	No	TS 32.692 swName = active SW running on the unit; e.g. 5gDUv18.05.201.
manufactureDate	string	No	TS 32.692 dateOfManufacture = manufacture date of the unit in ISO 8601 format; 2016-04-23.
lastServiceDate	string	No	TS 32.692 dateOfLastService = date of last service in ISO 8601 format; e.g. 2017-02-15.
additionalFields	hashMap	No	Additional registration fields if needed, provided as key-value pairs.

pnfRegistration VES Event

```
"event": {
  "commonEventHeader": {
    "domain": "pnfRegistration",
    "eventId": "pnfreg000000001",
    "eventName": "Pnfreg_du-Nokia",
    "lastEpochMicrosec": 13172659790000000,
    "priority": "Normal",
    "reportingEntityName": "NOK1234567890",
    "sequence": 0,
    "sourceName": "NOK1234567890",
    "startEpochMicrosec": 13172659790000000,
    "timeZoneOffset": "UTC+06:00",
    "version": "4.0.2",
    "vesEventListenerVersion": "7.0.2"
  },
  "pnfRegistrationFields": {
    "additionalFields": {
      "Name1": "Value1",
      "Name2": "Value2",
      "Name3": "Value3",
      "Name4": "Value4",
      "Name5": "Value5"
    },
    "lastServiceDate": "10FEB2019",
    "macAddress": "FF:28:22:34:45:56",
    "manufactureDate": "FEB2018",
    "modelName": "FE934567",
    "oamV4IpAddress": "10.255.1.254",
    "oamV6IpAddress": ":::",
    "pnfRegistrationFieldsVersion": "2.0",
    "serialNumber": "NOK1234567890",
    "softwareVersion": "5gDUv18.05.202",
    "unitFamily": "BBU",
    "unitType": "5gDU",
    "vendorName": "NOKIA"
  }
}
```

PRH Enhancements

PNF Registration Handler (PRH) Enhancements.



(1) New VES Event domain for PNF Registration – Create new VES event domain *pnfRegistration* for PNF registration with corresponding support in VES collector, DMaaP and PRH. PnP Use case was using the “*other*” domain to register VES events. For Casablanca, we propose using a dedicated domain. VES separation of events. VES agent update in PNF.

(2) VES EXTENSIONS - As a result, VES collector and VES agent content will change with field updates using the new domain. Extensions for PNF registration fields. Corresponding VES Schema change (VES message 6.0 standard)

(3) PNF REGISTRATION EXCHANGE UPDATE – The registration VES event used by the DU Simulator (or actual PNF) will need to update its JSON payload to match the changes above.

(4) TOPIC CREATION – Once DMaaP is secured, creation of new *pnfRegistration* DMaaP Topic. Topic needs to be pre-provisioned. *pnfReady* event.

(5) AAF & PRH – Intra-ONAP Security. PRH integration with AAF for security. Refactor VES.

(6) FAILURE HANDLING – Error handling for when registration fails. (1) send response didn't find AAI keep sending (2) avoid multiple PNF ready to SO for same PNF. (3) AAI unavailable ONAP components not running (4) PNF sending erroneous info. (5) Failures on (a) PNF registration (b) DMaaP PNF Ready (c) AAI (d) Platform (6) VES Schema validation (7) **PNF timeout & max# tries (actual DU).**

(7) SO INTEGRATION – SO WF Integration. Service Instance (Timeout = wait for 2 weeks). External inventory monitoring system.

(8) REQUIREMENTS PROJECT – Add requirements: for all equipment providers their PNFs have to use this event.

PROJECTS

PNF Registration Handler, DMaaP, DCAE

SECURITY ENHANCEMENTS

HTTP

- ONAP to eliminate username and password for HTTPS.

TLS

- DCAE authenticates Vendor or Service Provider X.509v3 certificate for TLS connection.
- ONAP User is able to install Vendor Root CA certificate as trust anchor in ONAP.
- ONAP supports 3 level chain (Root CA, Sub CA and End-Entity certificates).
- Vendor is able to install ONAP Root CA as trust anchor on NF for mutual TLS authentication.

CA

- Provide CA services to NFs in ONAP for development and testing; enrollment, authentication.
- Support CMPv2 for NF for certificate enrollment and end-entity key renewal in ONAP for development and testing.
- Support integration with Service Provider CA/PKI in ONAP.

SSH/SFTP

- Create RSA public/private key pair for ONAP Controllers and File Collector for SSH/SFTP access into the NF for CM/PM.
- Provision SSH username/public key on NF for Ansible or NetConf access from ONAP Controllers for CM and SFTP.
- Client shouldn't accept username / password for SSH authentication.



PROJECTS

PNF Registration Handler, DCAE, AAF,
ONAP Controller, DMaaP

STEP	DESCRIPTION
23	DHCP Request –ONAP Onboarding S/W performs a DHCP procedure with vDHCP
24	DHCP Response – DHCP response returns a ONAP IP address
25	Authenticate PNF – The PNF is authenticated through a vAAA.
26 & 28	<p>PNF REGISTRATION – The PNF periodically generates a VES Event (json schema extend for discovery event) to DCAE which is the “triggering” event that tells ONAP that the PNF is trying to register. This event contains the Correlation ID (PNF ID), which will serve as an identifying key within A&AI to seek for that particular PNF instance. The event also contains the PNF OAM IP address and the vendor name. PNF sends the Event over an HTTPS connection which may be authenticated with a username and password. The Event is “standardized” and is the same for all hardware (PNF) irrespective of equipment vendor, thus there needs to be ONAP compliant software. The PNF must natively support or have an adapter to be ONAP capable.</p> <p>Note [FUTURE]: A (new) “<i>PNF Infrastructure Manager</i>” may evolve in the future to include other management functions, as there may be a need for an entity that owns the interactions with device interactions w.r.t. ONAP. Management of devices vs containers. I/F manages & consumes services. VIM/Multi-Cloud. Multi-VIM PNF plugin. Multi-VIM would call the PNF infrastructure manager.</p>
27 & 29	INVENTORY QUERY – PNF Registration Handler performs an inventory Query to A&AI using the Correlation ID (based on the PNF ID) as the key. The AAI instance for this PNF ID must have already been created. If it has, then this is a valid, expected PNF. If not, then this is not a valid or not found a response is given to the PNF. In Step 32, PNF A&AI entry is found.
30	<p>UPDATE PNF ENTRY IN AAI – The PNF entry in AAI is updated with the PNF IP address. After this step, the PNF is considered to be active in ONAP and becomes available as an network element to fulfill service requests.</p> <p style="text-align: right; font-size: small;">Patch AAI MO command If {entry} {error & exit} If {entry} {overwrite & send PNF Ready}</p>
31	PNF READY - PRH publishes a PNF Ready event on the DMaaP bus to which SO subscribes. SO receives the PNF Ready event, determines that it is an event it is waiting for and rehydrates the appropriate RLF to restart the Service Instantiation
(15-22)	SERVICE INSTANTIATION PROCESS (PART 1) – Steps 15-22, the Service Instantiation Process (part 1) occurs in parallel to these steps. When that process reaches the pending point (denoted by ) it rejoins the flow here. PNF previously declared.
32	PNF REGISTRATION RESPONSE - There is discussion whether in the failure cases of PNF registration if a response back from ONAP should be sent. Under consideration for Casablanca release (R3)

Stage 5: PNF Activation Steps (ONAP)

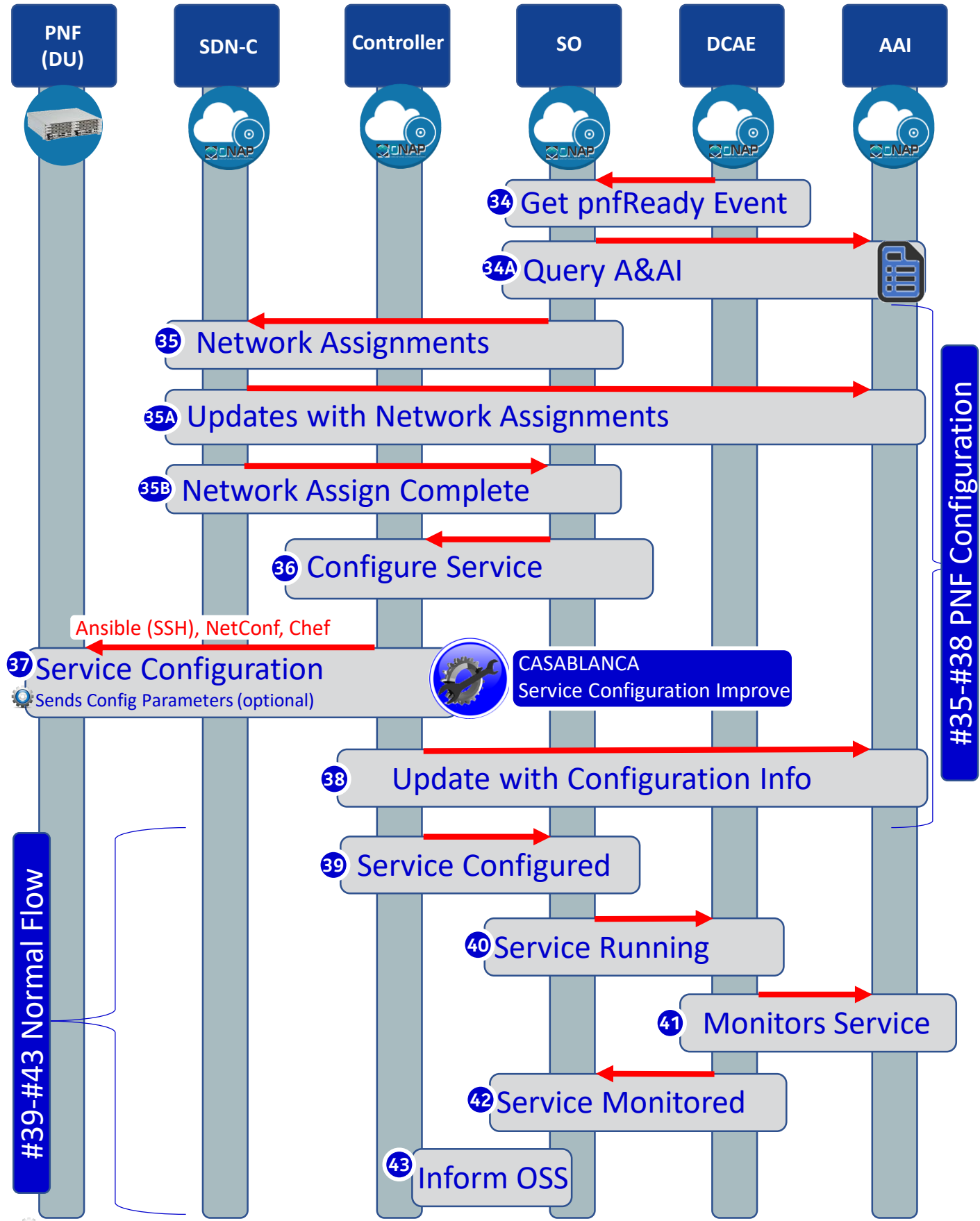

SERVICE CONFIGURATION ENHANCEMENT

DESCRIPTION

- (1) Service configuration Enhancements** to ONAP Controller to PNF *service configuration* exchange with PNF.
- (2) PROTOCOL DEFINITION** – Framework for how SDN-R will support NetConf, Ansible, Chef. All 3 are expected to be supported with PNFs. How is the protocol agreement done?
- (3) Configuration Extensions** – New parameters needed for Casablanca use cases. Vid script to pushing data, ID config, ID where data comes from. Generic configuration support.
- (4) PNF PnP Config** – Finishing PNF PnP by sending down config data.
- (5) (OPTIONAL) Vendor Data** – Extensions to Service Configuration with Vendor specific configuration data can be developed (vendor dependent).



PROJECTS

ONAP Controller (SDN-R), VID, SO,
SDC/CDT

STEP	DESCRIPTION
34	SO NOTIFIED - PNF Infrastructure Manager Notifies SO. SO listens to the DMaaP hook. A trigger. Wait for PNF onboarded. Calls SDN-C.
35	NETWORK ASSIGNMENTS – SDN-C assigns an IP Address for PNF. The IP @ assigned to the PNF is drawn either from the DHCP server, IP address Pool, or a Static IP@. Managing physical/virtual links to PNF. Between CU & DU. Transport connectivity setup. SDNC makes assignments, the resource model have external/internal connection points (named). For each point, attributes say L1/L2 connection. If L3 who assigns the IP address. Each point, SDNC knows if and what to assign. Set either through SDNC (L0-L3) or APP-C (L4-L7). Driven by TOSCA Model.
36	ACTIVATE – Configuration & Activation of the PNF Depends on the resource type. The controller requires input data based on PNF type. Either VF-C or APP-C orchestrate with SO. The IP@ is retrieved SDNC instance manager for PNF and the DHCP server may be updated. Pass on configuration parameter(s). (Future) retrieve VNF a configuration parameter.
37	 SERVICE CONFIGURATION – APP-C calls Ansible to configure PNF’s (Configuration Parameter) NetConf messages from SDN-C to PNF. (1) Configuration Parameter (optional) – SDN-R/APP-C gives the Controller IP@ to the DU. In R3, SDN-R/APP-C may pass configuration parameter(s) to the 5G DU, this will also give a configuration parameter (e.g. CU IP@). (2) OAM IP@ (optional) - The permanent OAM IP address is given to the PNF. The IP address may come from vAAA, or drawn local pool of IP addresses. SDN-C performs the IP address selection. SDN-C knows if a permanent IP address should be assigned. (3) Transport configuration (optional) – Transport configuration is given to the PNF. (4) Location (optional) – the Location configuration may be given to the PNF. (5) Software Version (optional) – In Casablanca it could be specified a Software Version. http://onap.readthedocs.io/en/latest/submodules/appc.git/docs/APPC%20LCM%20API%20Guide/APPC%20LCM%20API%20Guide.html
38	SDN-C Updates A&AI – SO updates A&AI with Network Assignments (from step 35)
39	SDN-C replies to SO – SDN-C replies to SO are the service configuration step.
40	Service Running – SO publishes a “Service running” event to which DCAE subscribes.
41	Monitors Service - DCAE reads A&AI entry and sets up monitoring for the new service. DCAE publishes “Service monitored” event to which SO subscribes. For monitoring events, the DU will be managed by the CU (in the FUTURE an M-Plane will be setup to ONAP to DU
42	OSS Inform - SO responds to User/BSS/OSS that the service is active.

Stage 5: PNF Download & Activation (Vendor Specific)

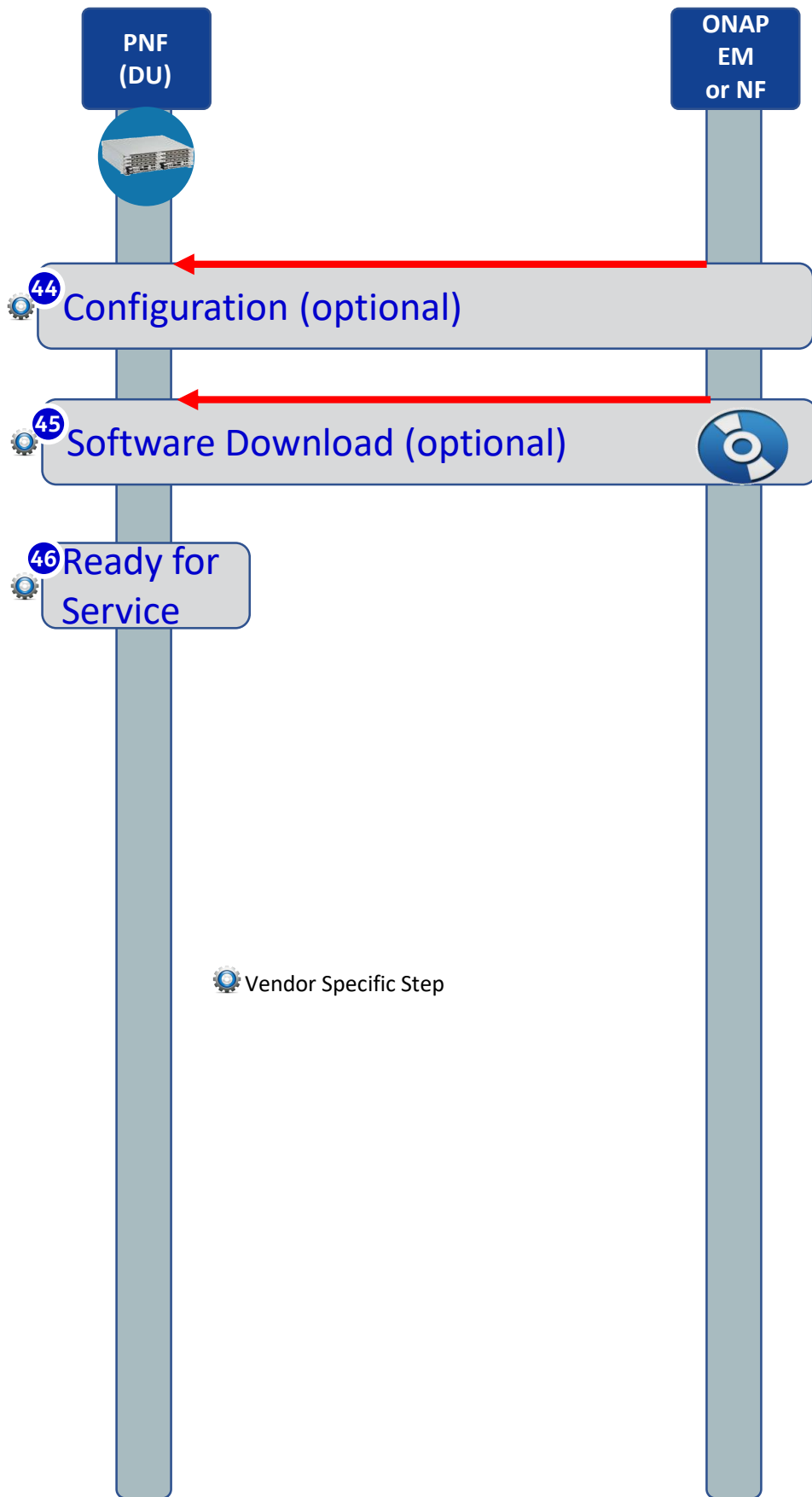



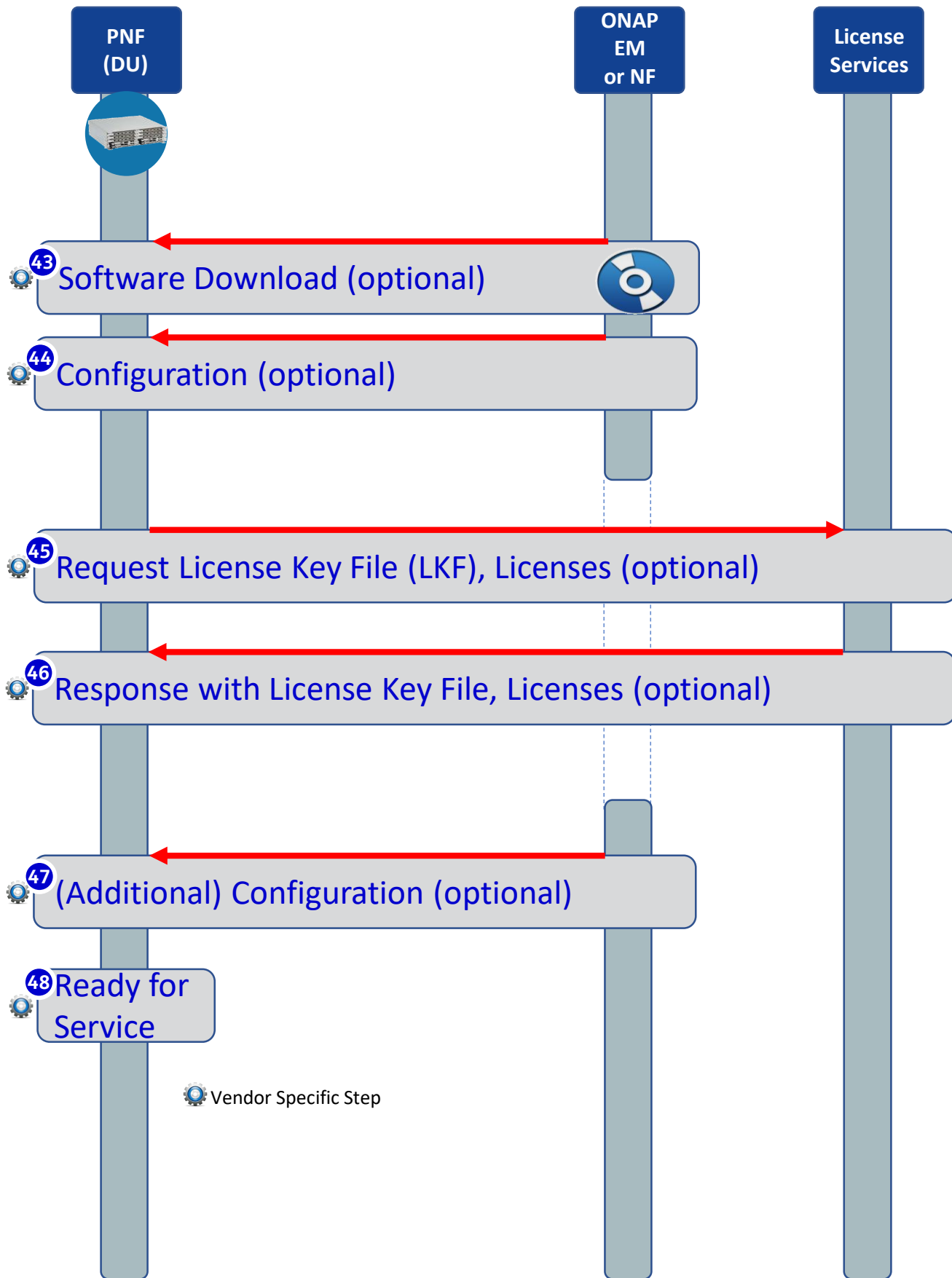

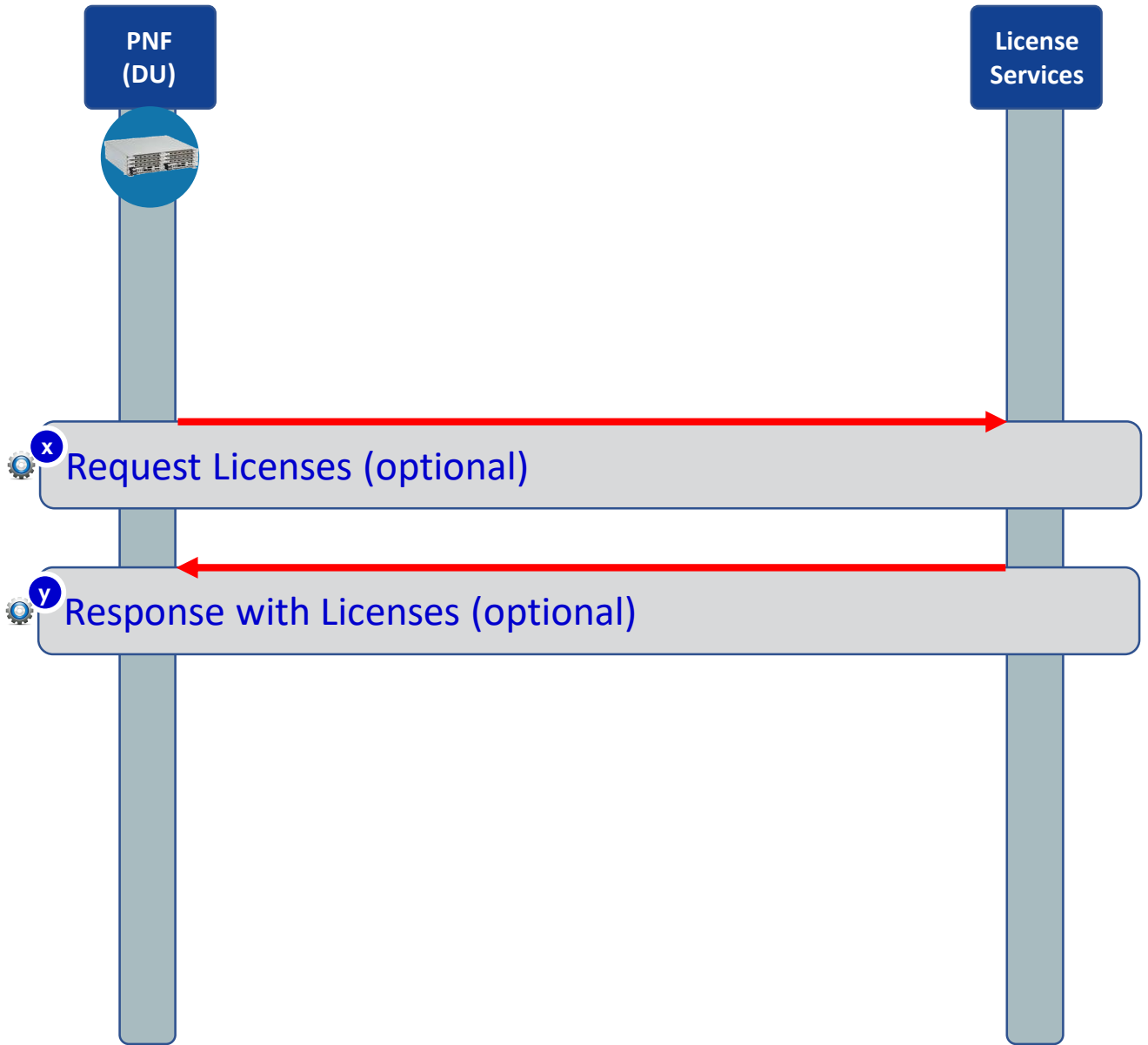

Stage 5: PNF Download & Activation (Vendor Specific)





Stage x: PNF PnP & Vendor Specific License Service



STEP	DESCRIPTION
43 	CONFIGURATION (Optional) – The configuration information is downloaded from [ONAP, EMS, or another PNF] to the DU. This information provides operational configurations and settings which are vital for service. They would be pre-provisioned and allow the PNF to operate with specified configurations, optimizations, RF settings, connectivity, and L1/L2 algorithmic settings.
44 	SOFTWARE DOWNLOAD (Optional) – Software download from [ONAP, EMS, or another PNF] to the DU. This software download is optional and is specific to a vendor.
45 	REQUEST LICENSES (Optional) – The 5G PNF (DU) contacts the License Service to request license key file (LKF) and license data. NetConf Mask. Feature License (License to Use). Capacity license. Partial data model exposure.
46 	INSTALL LICENSES (Optional) – The License Service returns the LKF and license data and the PNF installs them
47 	CONFIGURATION (Optional) – Additional configuration information may be downloaded based on the licenses and LKF that had been installed.
48 	DU RESTART (Optional) – The 5G PNF (DU) is ready to provide service using the configuration provided to it. Typically, a test call is performed to verify service is working end-to-end. A DU restart may occur (optional, and vendor specific) based on service provider/ vendor procedure.

 Vendor Specific Step

STEP	DESCRIPTION
45 	REQUEST LICENSES (Optional) – The 5G PNF (DU) contacts the License Service to request licenses.
46 	RESPONSE WITH LICENSES (Optional) – The License Service returns licenses and the PNF can install them

 Vendor Specific Step

VNF vs PNF Comparison

TOPIC	VNF	PNF
Concept	Application fulfills the role of a network function.	It is a network element, a physical entity, which can implement the role of a network function.
Physical Characteristic	Application without dedicated hardware; Virtualized applications require specific capabilities; Run on different vendor servers. SRIOV, Inter-DPDK. Hardware capabilities.	Has an actual physical asset that is deployed and associated directly with the PNF.
On-boarding	To onboard a VNF is to “bring it into ONAP” i.e. the VNF images, component VNF-C provide descriptors of these NFs. Deployment model, # components, functions. Configuration parameters. VNF is not tied or optimized for a specific hardware, only requiring perhaps some capability to be supported.	For PNF provide the descriptors. Only provide the meta-data. PNF S/W specifically optimized to run on dedicated hardware. (Now) Not the software image. (Future) ONAP will provide the software image repository.
Plug and Play	The model triggers the orchestration.	(See this slide package for PNF Plug and Play) at the end of PnP the PNF can provide service.
Characteristics	5G CU could be a VNF since there is no need to have an association to a physical environment.	5G DU must be PNF. PNFs are Elements which may need to interact with the physical environment. PNF is “High-Touch” technology. E.g. Emit radio waves in a geographical area.
Configurability & Deployment	Easily adaptable to functions that you expect. E.g. Packet gateway to reconfigure as different NFs. Services easily create instances reconfigures including deployments (for different applications). Use a different instances of the VNF to provide a new service. For a VNF you can easily “delete” and “create” a new VNF to perform a new function. Configured dynamically.	PNF has a “fixed” set of capabilities but can’t easily reconfigure it. One PNF in multiple services. Different capabilities exposed by the PNF. Reuse the same PNF with different services configuration. For a PNF you would not “destroy” a PNF but rather re-configure it. Can be configured dynamically.
ONAP Interaction	ONAP is started with VNF. VNF is “deployed” on-demand. Control from the ONAP perspective when a deployment of a VNF happens. DCAE – same Configure – Chef, Ansible	PNF do not “deploy” application. Do not use multi-VIM. Only “configure” the application, the PNF is deployed. A technician goes to site and “deploys” a PNF. DCAE – same Configure – Implementation of PNF client. Communication protocol, Client
Design Time Modeling	Model VNF. Templates. Onboarded before. In Run-time. Make sure properly identify specific PNF instance already deployed. Vs a dynamically created instances. VNF instances could be created & instantiated dynamically. SDC may assumed instantiation of network function.	PNF cannot be instantiated, a PNF is only instantiated when it “powers up” and connects to ONAP. Service Orchestration. PNF is instantiated by nature of a PNF installation & commission procedure.
Service Orchestration	VNF cloud, #VM resources consumption, define components implement different functions. Where & What will be deployed.	Physical location, pre-provisioned capabilities, performance monitoring. Components installed. RUs for specific functions.
Resources	VNF dynamically assigned resources.	PNF statically associated (hardware) resources.
Capacity	VNF Capacity can be dynamically changed	PNF is static (number of cells supported)



PNF Plug and Play Project Impacts

- ONAP and PNF Plug and Play for 5G RAN
- 5G Use Case Team

Management Design

ONAP Project	IMPACT
Management Design	(After modeling, and instantiation) “in the middle” Policy Design changes? (check w/ Policy Project) CDT (APPC) - Networking Design – SDN-C design tool for networking design. Creates Yang files. Config Design

VID IMPACT

ONAP Project	IMPACT
VID & PNFID SUPPORT	<p>With Seshu (SO) decided will continue vCPE work-flow extensions. Show in integration team, interim test. VID Impact, the API of that SO work-flow is extended, which must consume the CORRELATION ID (PNF ID). The PnP registration workflow can be included into a broader use case work-flow. i.e. can “Cut & paste” to the vCPE/VOLTE work-flow. Any workflow that deploys a service. VID uses different APIs of different ONAP components. VID deploy VCPE. VID creates a new cell, format; calls extended API. Client call. GUI to SO/AAI. VID GUI uses REST APIs of other modules. Display parameters of other ONAP modules.</p> <p>#1A – PNFID SUPPORT – VID to support PNF-name/PNFid for SO instantiate vCPE/VoLTE Work-flow from Beijing (R2). SO work-flow API. [existing screens in VID – vCPE/VOLTE W/F]. Testing. Allotted VNF creation. Skip VNF part.</p>
VID & INSTANTIATION	<p>#1B – SERVICE INSTANTIATION – For R3, a vCPE W/F, want pnfRegistration use case supported by vCPE W/F, with new SO work-flow API. Camunda BPMN engine & external API. SO API internal calls mapped to Camunda. Sub-work flow to deal w/ pnfRegistration. VID needs to support instantiation of that work-flow. Maybe a new VID screen</p> <p>Q: <i>What is the W/F that we need to trigger? API/Payload details what input to ask user in VID (what data to supply). SO define APIs that VID consumes.</i> Krzyztof Kurczewski. SO uses a “generic API” for SDN-C. Create service instance in VID (PNFid) “instantiate”; service model.</p> <p>Q: association PNFmgmt cf BPMN PNF association to service instance from VID. (seshu: supported)</p>
VID & MULTI-PNF [FUTURE R4+]	<p>#3 – MULTI-PNFID - today we are asking VID to provide an additional PNFID to the work-flow. Integration want to use VOLTE have 2 instances of PNF (need 2 PNF ID). Infrastructure w/ 2 routers PNF create 1 service. 1 PNF:1 Service > n PNFs:1 Service. Slices share 1 PNF. 1 PNF:n Services. PNFID = Correlation ID. Study item (backlog). Q: <i>Will these APIs be ready in R3? API/Payload details.</i></p>
VID & WORK ORDER [FUTURE R4+]	<p>#4 – WORK ORDER (Optional) – Supporting Work Order. Supported with service specific applications. Inventory systems (optional). Future extension to ONAP. Interface w/ BSS-OSS systems (API).</p> <p>ACTION: Error cases (check if SDC model parameters != A&AI PNF entry)</p>
VID & AAI CREATION	<p>#5 – VID A&AI INSTANCE CREATION – (optional) (slide 20/Step 4) – VID supporting Resource Declaration a PNF A&AI Instance creation. Similar</p>

PNF REGISTRATION HANDLER IMPACTS

PNF Registration Handler (PRH) Project Impacts

NEW pnfRegistration DOMAIN



- (1) New VES Event domain for PNF Registration** – Create new VES event domain *pnfRegistration* for PNF registration with corresponding support in VES collector, DMaaP and PRH. PnP Use case was using the “other” domain to register VES events. For Casablanca, we propose using a dedicated domain. VES separation of events. VES agent update in PNF.
- (2) VES EXTENSIONS** - As a result, VES collector and VES agent content will change with field updates using the new domain. Extensions for PNF registration fields. Corresponding VES Schema change (VES message 6.0 standard)
- (3) PNF REGISTRATION EXCHANGE UPDATE** – The registration VES event used by the DU Simulator (or actual PNF) will need to update its JSON payload to match the changes above.
- (4) TOPIC CREATION** – Once DMaaP is secured, creation of new *pnfRegistration* DMaaP Topic #1 (Static). DMaaP Topic #2 (Static) needs to be pre-provisioned. *pnfReady* event.

AAF



- (5) AAF & PRH INTEGRATION** – Intra-ONAP Security. PRH integration with AAF for security.
- (6) VES INTEGRATION** – To authenticate VES collector and authentication of PNFs connecting to VES Collector. To facilitate this development, the VES S/W is being refactored.

FAILURE HANDLING

- (7) FAILURE HANDLING** – Error handling for when registration fails. (1) send response didn't find AAI keep sending (2) avoid multiple PNF ready to SO for same PNF. (3) AAI unavailable ONAP components not running (4) PNF sending erroneous info. (5) Failures on (a) PNF registration (b) DMaaP PNF Ready (c) AAI (d) Platform (6) VES Schema validation (7) **PNF timeout & max# tries (actual DU)**.

SO INTEGRATION



- (8) SO INTEGRATION** – SO WF Integration. Service Instance (Timeout = wait for 2 weeks). External inventory monitoring system. RH to support AAF authentication between RH and SO

REQUIREMENTS PROJECT



- (9) REQUIREMENTS PROJECT** – Add requirements: for all equipment providers their PNFs have to use this event.
- (a) PNF side: Requirement for PNF Time/Max# Tries
- (b) ONAP side: Timeout (e.g. 2 weeks)

DMaaP meeting – sunil unnava (MR), Dominic lunanova dgl@research.att.com (Bus controller)

Requirements Meeting – steven wright su622b@att.com

VID meeting - Ofir Sansino

SERVICE ORCHESTRATOR (SO) IMPACTS

SERVICE ORCHESTRATOR (SO) PROJECT IMPACTS

WORK FLOW Integration/ Testing (SO executor)

Create work-flow for PNF (Srini)
For configuration for SO
Coded in Beijing but needs yet to be integrated, tested, and accepted.
Note: One PNF workflow (SO) that has two entry points: (1) instantiate & wait (Step 16) (2) Update (Step 34). One BPMN.

AAF & PRH Integration

SECURITY - SO enhancement to support using AAF authentication between **PRH** and **SO** (will SO integration to AAF in general).
PRH to SO security – TLS, Certificates, Client/Server interaction, DMaaP. (1) MSB REST call (SDO). [Not an issue] (2) pnfReady (DMaaP). Requires AAF (needs to developed). Implement AAF in client.

SO TO Controller INTERACTION

1. **IDENTIFY THE CONTROLLER:** How should SO recognize which controller to use. STEP37 SO calls (Controller: APP-C, SDN-C, SDN-Cr/APP-Cr (SDN-R), VF-C Identified in PNF A&AI Entry) (Generic API call **vs** REST call (?)). List of operations.
PNFID > PNFID > Controller. **For R3 Hardcode controller to SDN-C**
2. **HOW TO CALL THE CONTROLLER** - API to the identified Controller. SDN-C (Generic API). North-bound would be SDN-C API (REST/RPC)
ACTION: [R3 CLOSED] SO Calls (Generic API) the Controller (SDN-C)

PNF WORKFLOW ENHANCEMENTS

Investigate the use of a Generic PNF workflow (will it work for 5G PNF). Investigate if enhancements (customizations) are needed to the PNF Workflow. Sub-Flow. BPMN (separate WF). PNF Auto-discovery WF. Stand-alone WF that can be “plugged” into other WFs.

MODEL DRIVEN

SO not yet model driven. Need to solve vis-à-vis a SO work flow specific to service & resource use case. *Controller type* to be used w/ PNF should be modeled in SDC.

DFX (Design for Excellence)

Resilience, Performance, Scalability, Stability, Multi-tenants (multi-tenants access). Multi-site (single instances of SO).

Controller Association

ACTION: [CLOSED] Identifying the PNF Controller (set in Design time). What is the API. ANSWER: fixed to SDN-C, Generic API.

Slide 19/Alt-2 Step 20

ACTION: “Manual” (Slide 19) vs Automated (Slide 26) (w/ Vimal, Gil)
CONCLUSION – [CLOSED] MOVED AS A PROPOSAL FOR DUBLIN

PNF Modeling IMPACTS in SDC Project

See the Slides
NFModeling Slides

(See the references section in this slide pack for a URL
to the slide pack)

ACTIVE INVENTORY (A&AI) IMPACTS

ACTIVE & AVAILABLE INVENTORY (A&AI) PROJECT IMPACTS

New A&AI PNF Parameters

~~**PNF GEOLOCATION**~~ – geographical location (e.g. coordinates or address of the building, etc.). Latitude/Longitude. **THIS ALREADY EXISTS VIA ASSOCIATION TO THE “COMPLEX” OBJECT.** The Complex Object represents a BUILDING or location with geographical information. The AAI PNF will have a UML association to the Complex object.

S/W Image Repository



S/W Image Repository – Where the S/W is located. Configuration Parameter. IP address to where the NF’s S/W repo is. *[Doesn’t really belong in A&AI]. CM DB? Run-Time Catalog?*

Homing



PNF [#1:CU/#2:ONAP] CLOUD HOME (CLOUD SERVER LOCATION) – PNF is served by some regional ONAP cloud servers. Serves in “Rehome” PNF. **CLLI Code** (specifies location, street address, **CloudID**, physical server is deployed). [Potentially a list of locations]
 OOF determine the homing of a NF. Anything you home is determined in the context of a deployment. (Homing) Policy used as a f(service). Data center might have been divided into cloud regions. Service VMME running in NE area (distances, regions, tenants where to instantiate PNF). AAI has **COMPLEX node**. “Physical Location ID” (8 char CLLI code, lat/long = geolocation info of data center. Cloud region doesn’t span data centers.

External Manager IP Address



NF-M External Manager IP Address – provides an additional IP address for the BTS that is vendor-specific and relevant to the OAM management of the BTS. External Manager needs to be associated with a PNF.
 ESR.

<https://onap.readthedocs.io/en/beijing/submodules/aai/esr-server.git/docs/>
<https://onap.readthedocs.io/en/beijing/submodules/aai/esr-server.git/docs/>
<https://wiki.onap.org/pages/viewpage.action?pageId=11930343#A&AI:ExternalSystemOperationAPIDefinitionInESR-EMSregistration>

SUGGESTION (from Christina A&AI) model the NMS as a PNF itself (and the NMS will have parameters to represent itself; and then PNF can be associated with it). [REJECTED]
 ESR - Stores system information for external systems not part of ONAP, needs information system information (credentials). AAI ESR; ESR server Module, ESR gui Module; ESR schema section in A&AI Schema. Talk to ESR team if the ESR objects could be linked to the PNF. @LiveBo, & Christina. Would CCVPN schema changes already cover this? ESR system info as external AAI. Related PNF to external system.

<https://wiki.onap.org/display/DW/AAI-CCVPN+Schema+Proposal+for+Casablanca+Release>

S/W Image Repository

ACTIVE & AVAILABLE INVENTORY (A&AI) PROJECT IMPACTS

Software Version

DETECTED SOFTWARE PNF VERSION(S) – `swVersionList`.

R3 Casablanca – This will be a list of software versions. In Run-Time when PNF registers with ONAP it can report its (list) of PNF Software that is currently has installed. This will be tracked in A&AI entry for that PNF. Entry will also an indication that one is *Active*.

R4 Dublin – proposing software Object which could be linked by SDC and A&AI.

`swVersion [1...x] (Array)`

{

`swVersion (String)`

`activeSw (Boolean)`

}

External Manager

<https://wiki.onap.org/display/DW/AAI-CCVPN+Schema+Proposal+for+Casablanca+Release>

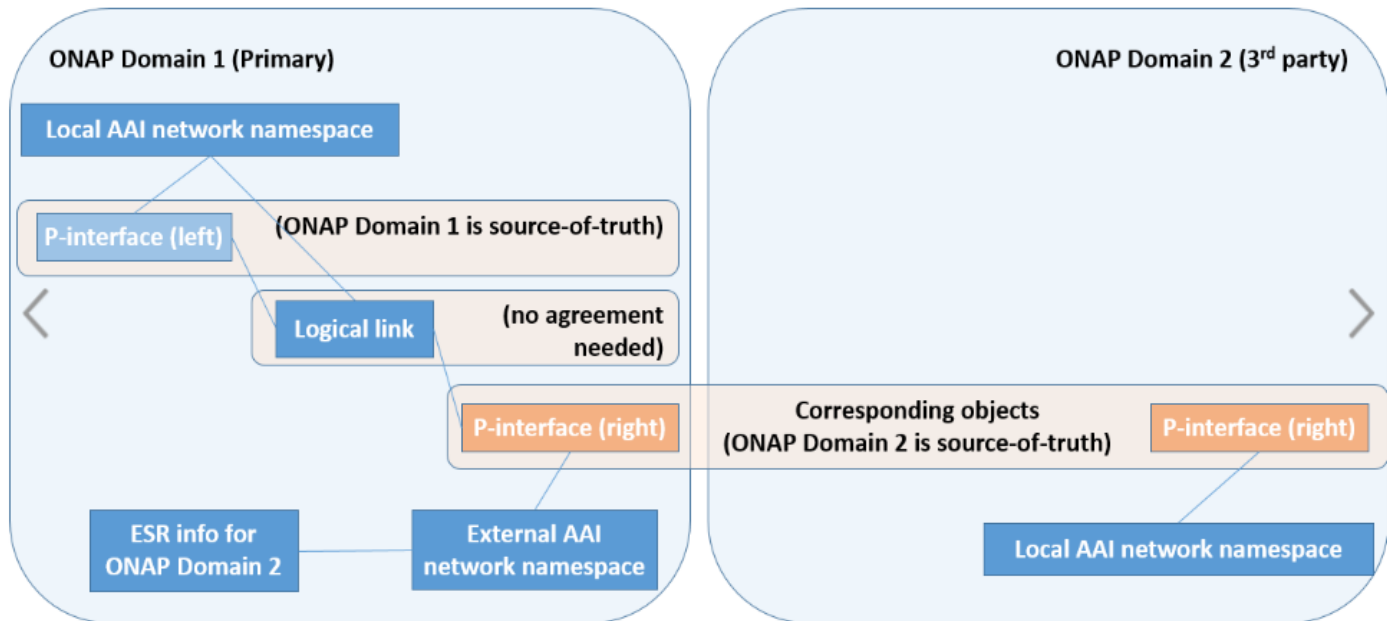

AAI-1353-12

cross-domain link

Notes:

See Figures 5, 6, 7, 8 and 9 above.

Record information in AAI that crosses between ONAP Domain 1 and ONAP Domain 2

new proposed elements "external-aai-list" and "external-aai":

[Mockup Schema \(OXM\)](#) > Expand source

[Mockup API](#) > Expand source

```

<java-type name="ExtAaiNetwork">
  <xml-root-element name="ext-aai-network" />
  <java-attributes>
    <xml-element name="aai-id" type="java.lang.String"
      required="true" xml-key="true">
    <xml-element name="schema-version" type="java.lang.String">
    <xml-element name="esr-system-info"
      type="inventory.aai.onap.org.v14.EsrSystemInfo" />
    <xml-element name="logical-links"
      type="inventory.aai.onap.org.v14.Logicallinks" />
    <xml-element name="vpn-bindings"
      type="inventory.aai.onap.org.v14.VpnBindings" />
    <xml-element name="pnfs"
      type="inventory.aai.onap.org.v14.Pnfs" />
  
```

As

```

<xml-root-element name="ext-aai-network" />
<java-attributes>
  <xml-element name="aai-id" type="java.lang.String"
    required="true" xml-key="true">
  <xml-element name="schema-version" type="java.lang.String">
  <xml-element name="esr-system-info"
    type="inventory.aai.onap.org.v14.EsrSystemInfo" />
  <xml-element name="logical-links"
    type="inventory.aai.onap.org.v14.Logicallinks" />
  <xml-element name="vpn-bindings"
    type="inventory.aai.onap.org.v14.VpnBindings" />
  <xml-element name="pnfs"
    type="inventory.aai.onap.org.v14.Pnfs" />

  <xml-element name="connectivities"
    type="inventory.aai.onap.org.v14.Connectivities" />
  <xml-element name="lan-port-configs"
    type="inventory.aai.onap.org.v14.LanPortConfigs" />
  <xml-element name="network-resources"
    type="inventory.aai.onap.org.v14.NetworkResources" />
  <xml-element name="site-resources"
    type="inventory.aai.onap.org.v14.SiteResources" />
  <xml-element name="sdwan-vpns"
    type="inventory.aai.onap.org.v14.SdwanVpns" />
  <xml-element name="devices"
    type="inventory.aai.onap.org.v14.Devices" />
  
```

(A&A) swVersionList (R3)

ACTIVE & AVAILABLE INVENTORY (A&A) PROJECT IMPACTS

swVersionList

DETECTED SOFTWARE PNF VERSION(S) –

R3 Casablanca – This will be a list of software versions. In Run-Time when PNF registers with ONAP it can report its (list) of PNF Software that is currently has installed. This will be tracked in A&A entry for that PNF. Entry will also an indication that one is *Active*.

swVersion [1...x] (Array)

{

swVersion (String)

activeSw (Boolean)

}

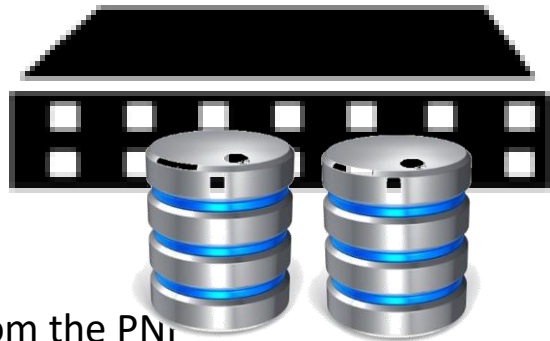

PROBLEM: Report the swVersionList from the PNF

SOLUTION: pnfRegistration Event

Swload 1.2

Swload 1.4

IMPACT: VES event Listener document (Alok)

IMPACT: PRH S/W

IMPACT: A&A Implement the inclusion of swVersionList in PNF object

Each PNF has its own *unique* set of software

West-side Region #1 S/W version 2018.08A

East-side Region #2 S/W version 2018.07D

PNF #1 – [Partition #1] 2018.08A (activeSw = TRUE),

[Partition #2] 2018.07D (activeSw = FALSE),

[Partition #3] 2018.05C (activeSw = FALSE) [West]

PNF #2 - 2018.08A, 2018.07D, 2018.05C [West]

PNF #3 - 2018.08A, 2018.07D [West]

PNF #4 - 2018.07D, 2018.05C [East]

PNF #5 - 2018.07D [East]

Keong

keong.lim@huawei.com

CCVPN

Pattern introduce

List of Complex Objects in TOSCA Model
Migration

(A&AI) swVersionList (R4+)

Modeling Sub-committee

A&AI

SDC

DCAE (Analytics)

New Data Type

Software (object)

FIELD	TYPE	DESCRIPTION
software-id	String	Index key for this object
swDescription	String	Descriptive text of the software
swVersion	String	The version of this software
swVendor	String	Vendor for this software
swVersionLabel	String	Semantic label for the software

PNF A&AI Entry

PARAMETER	DESCRIPTION
PNF-NAME	<p><i>pnf-name</i> is the Key in AAI. <i>pnf-name</i> is the first three letters of the Vendor and PNF serial number. This is a unique identifier for the PNF instance. It is also called the Correlation ID.</p> <p>Note: MAC address & serial number are unique per vendors; not across vendors, so the Vendor name is added to insure uniqueness.</p> <p>Pservers, compute host, copied model & propagated</p>
EQUIP-TYPE	The <i>equip-type</i> parameter gives the type of the PNF.
EQUIP-VENDOR	The <i>equip-vendor</i> is an optional parameter which indicates the vendor for the PNF. For example, Nokia or Ericsson.
EQUIP-MODEL	The <i>equip-model</i> is an optional parameter which indicates the model of the PNF.
PNF-ID	<p>UUID = Service provider assigned number from network planner.</p> <p><i>Globally unique identifier for an instance of a PNF.</i></p>
MANAGER IP ADDRESS	adds <i>ipaddress-v4-oam</i> ; <i>ipaddress-v6-oam</i> This is the “manager IP Address” which for a DU might be a CU IP address; (FYI/ <i>ipaddress-v4-loopback-0</i>).
MAC ADDRESS	This is the MAC address of the PNF. This is a service field.
SERIAL NUMBER	This is the serial number of the PNF. This is a service field.
PROXY IP ADDRESS	This field contains the <i>proxy IP address</i> for the PNF.

Model Version ID – version of model

Model invariant ID – for all version of this model find me all the instances

Internal Model

Onboarding Model > Catalog

“Model” has version ID

That value in AAI for instances from that model

Not stored in ID of instance

CHESLA WECHSLER (AT&T)

ACTIVE INVENTORY (A&AI) IMPACTS

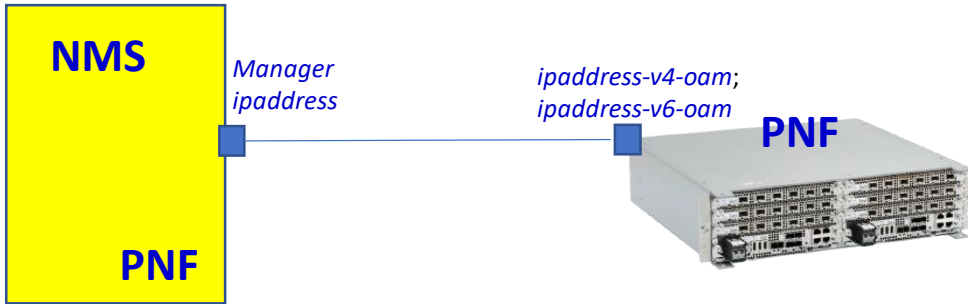

OAM
FCAPS
Logging
SWM
Identity

1. ONAP -> NMS command
2. Relay (NMS trusted source)
3. Network Analytics – (DCAE AA)

5G RAN W/F

VNF instantiation
Sub-W/F

PNF Plug and Play UC
Sub-W/F

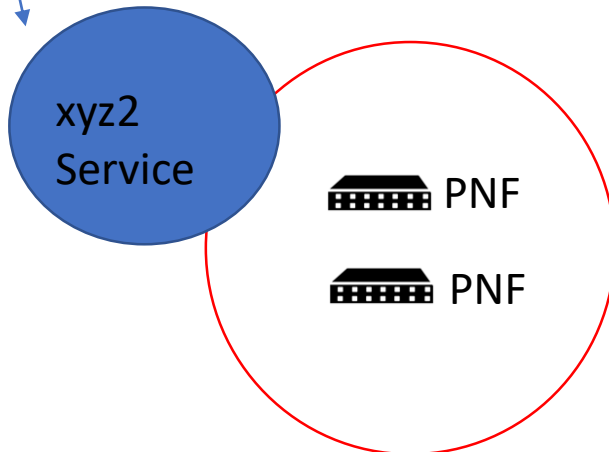
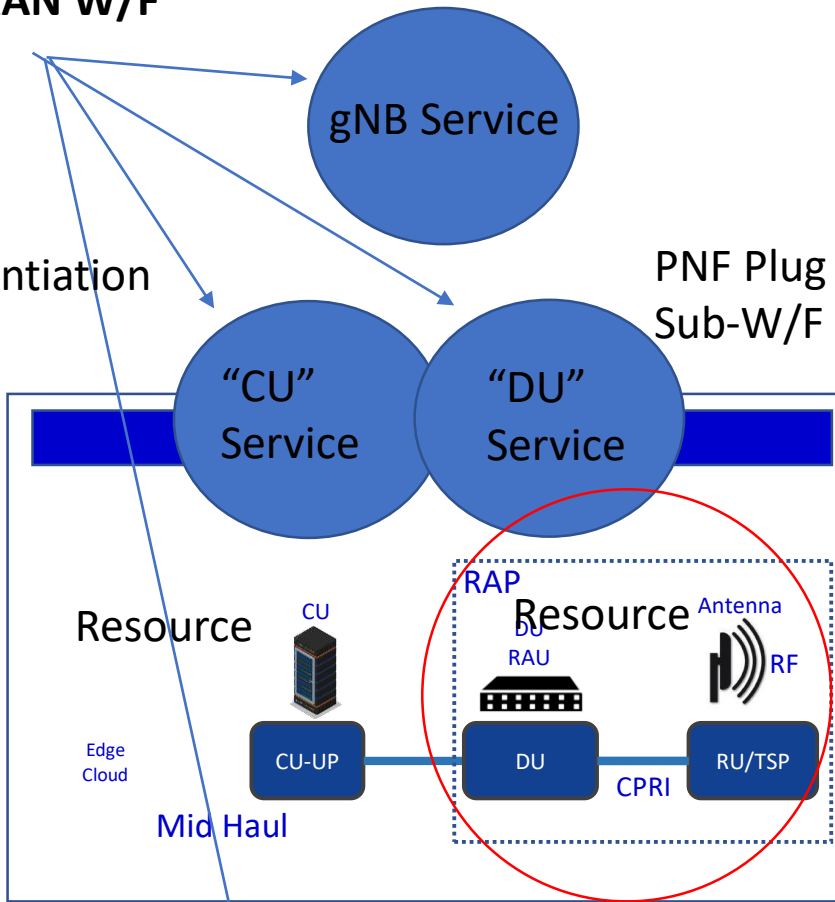

COMPLEX OBJECT

Physical Location

Manhattan
Freedom Tower
123 Main St.



Staten Island

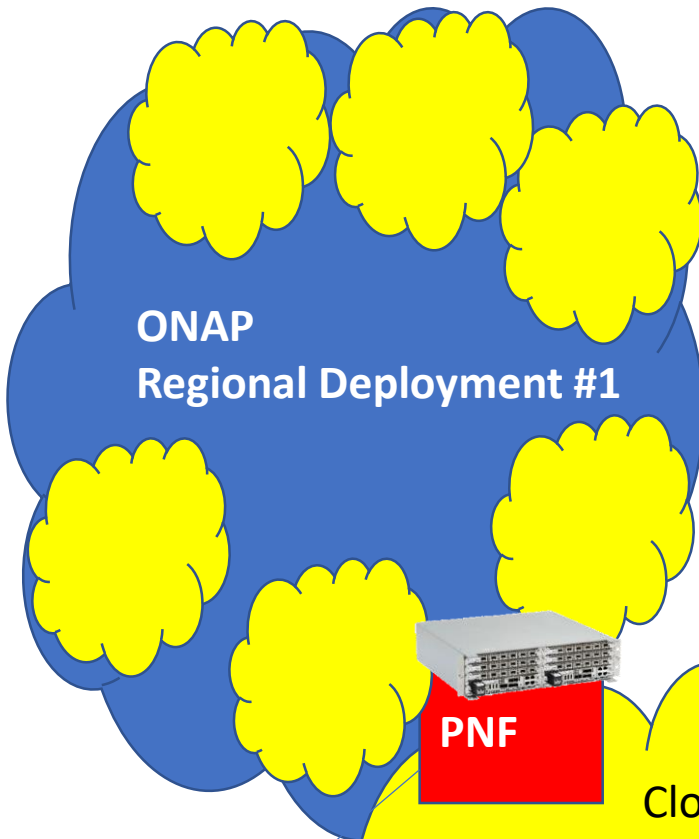

ONAP
Regional Deployment #1

PNF

LATA

PNF
Controller

Cloud Region
Object

Cloud Region #1

Complex
Object

Complex
Object

Complex
Object



<https://wiki.onap.org/pages/viewpage.action?pageId=25431491>

Create a Complex Object

PUT /aai/v11/cloud-infrastructure/complexes/complex/cli2 HTTP/1.1

Host: <AAI_VM1_IP>:8443

X-TransactionId: 9999

X-FromAppld: jimmy-postman

Real-Time: true

Authorization: Basic QUFJOkFBSQ==

Content-Type: application/json

Accept: application/json

Cache-Control: no-cache

Postman-Token: 734b5a2e-2a89-1cd3-596d-d69904bcda0a

```
{
  "physical-location-id": "cli2",
  "data-center-code": "example-data-center-code-val-6667",
  "complex-name": "cli2",
  "identity-url": "example-identity-url-val-28399",
  "physical-location-type": "example-physical-location-type-val-28399",
  "street1": "example-street1-700MountainAvenue",
  "street2": "example-street2-GlenSideRoad",
  "city": "example-city-MurrayHill",
  "state": "example-state-NewJersey",
  "postal-code": "example-postal-code-07974",
  "country": "example-country-UnitedStates",
  "region": "example-region-val-28399",
  "latitude": "111.1",
  "longitude": "234.2",
  "elevation": "example-elevation-538feet",
  "lata": "example-lata-val-28399"
}
```

DCAE IMPACTS

DCAE PROJECT IMPACTS

**Security
Validation**

Authenticate Connection

MONITORING

Monitoring definitions – SDC has a side monitoring template designer. Way to define monitoring alarms etc; In AT&T there is a project; IN ONAP code is there finalizing code; pluggable modeler for monitoring. DCAE as part of onboarding specify what VES template. DCAD define microservices for monitoring. How is PNF monitored & correlated. If [x] goes down how is this correlated. SDC would define the Modeling what needs to be monitored and how they would correlated with other events from other NE. Thresholds. [Baby step to process get an alarm from PNF, YAML file describes fault VES event, Fault meta-data; alarms generate].

**(PRH DCAE
Plug-in)**

(see PRH Impacts)

SDN-R (Controller) IMPACTS [APP-C]

SDN-R APP-C PROJECT IMPACTS



CC-SDK (SDN-R)

Artifacts from CC-SDK, APP-C

Mobility controller

Artifacts “borrowed” will become part of CC-SDK

Available for all controller persona.

QUESTION: moving towards CC-SDK & common foundation is there anything

On top of that planned for SDN-R.

Some thing specific to wireless, ... perhaps they do not belong in CC-SDK.

Things borrowed from CC-SDK and libraries that are common.

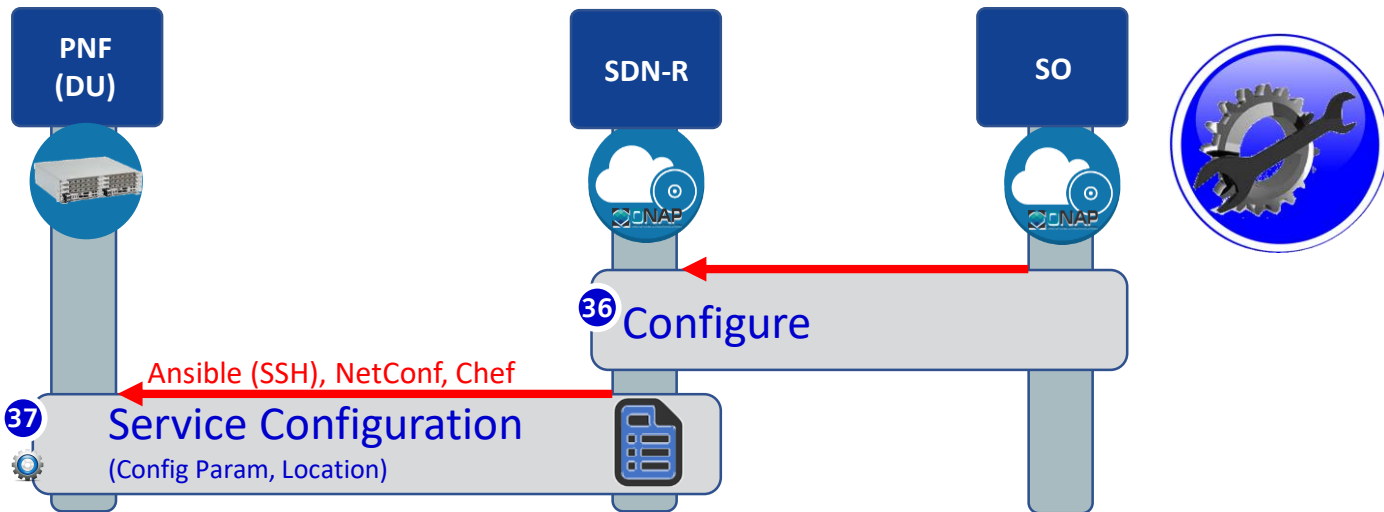

PNF Controller (SDN-R) w/ PnP in R3



SDN-R is ONAP controller derived from CC-SDK that combines functionality of APP-C & SDN-C and includes wireless artifacts.

SDN-R FUNCTIONS	DESCRIPTION
PROTOCOLS SUPPORTED	Ansible, Chef, and NetConf (all 3 will be supported)
PNF SUPPORTED	(5G Radio RAN Wireless) PNF
PNF DATA SUPPORTED	 <p>(1) Configuration Parameter (optional) – SDN-R/APP-C can give the Controller IP@ to the PNF.</p> <p>(2) OAM IP@ (optional) - The permanent OAM IP address is given to the PNF. The IP address assigned from SDN-C may come from the vAAA, or it may draw from a local pool of IP addresses. SDN-C performs the IP address selection. It knows if a permanent IP address should be assigned to the PNF. Note: this IP@ assignment <i>optional</i>.</p> <p>(3) Transport configuration (optional) – Transport configuration is given to the PNF.</p> <p>(4) Location (optional) – the Location configuration may be given to the PNF. [in A&AI Complex Object association]</p> <p>(5) Software Version (optional) – The expected PNF Software Version(s) is given to PNF (Controller reads the Detected PNF S/W version).</p>

SDN-R w/ PnP in R3

SDN-R FUNCTIONS	DESCRIPTION
PROTOCOL SPECIFIED	<p>PNF onboarding package defines of PNF (protocol). PNF info model (SDC) will have (1) protocol (2) controller:</p> <p>(1) <u>Protocols Supported</u> – PNF package. CM Protocol is in PNF onboarding package.</p> <p>(2) <u>Controller type</u> – defined in design time. Controller type is specified in design time. Design time designer specifies which controller is used.</p> <p>Distributed in PNF Modeling artifacts <u>R3 CONCLUSION:</u> This is still an open point (July 25, 2018)</p>
MODEL DRIVEN DESIGN	<p>APP-C, SDN-C, SDN-R, VF-C as possible controllers. Modeling which controllers will be used by the PNF. Also needs to standardize what it expects from controller. Things controller needs to support.</p> <p><u>R3 CONCLUSION:</u> SDN-C is fixed PNF controller.</p>
VENDOR SPECIFIC ADAPTOR 	<p>Customized DG (directed graph) element ODL (node in graph database) added with Java. Substitute a value and add fields in a template. SDN-R is following DG abstraction. If there is a vendor specific plug-in in the service model it can be represented as a node in DG and the interaction will be captured in that model.</p> <p><u>R3 CONCLUSION:</u></p>
UPDATING PNF & CONTROLLER RELATION INFO	<p>Updating the PNF controller/protocol (“lifecycle management”). <u>R3 CONCLUSION:</u> This will not be in R3, PNF has hardcoded Controller</p>
ERROR LEGS (ERROR FLOWS) 	<p>Errors when SDN-R interacts w/ a PNF <u>R3 CONCLUSION:</u></p>
JIRA-260 (SDN-C) 	<p>[Oct 1, 2018] Ansible infrastructure available. Need Ansible Play-book and Directed Graph to be developed. API of SDN-C/SDN-R which can be used. Is there a Work-flow in SO (BPMN) using this API. Sub-work performing step 37.</p> <p>ACTION-1: (Tool/Infrastructure) Verify with DAN Timoney what might need to be developed as an Ansible Play-book or Directed Graph.</p> <p>ACTION-2: (Use) Meet Seshu and add the Step 37 into a VCPE-subPNFPnP-subStep37 Work Flow (avoids the need to manually perform Step 37) [Generic API]</p>

SDN-C/SDN-R Config Database

PARAMETER	DESCRIPTION	Type
PNF-NAME	<i>pnf-name</i> is the Key in AAI.	String
Controller IP address	IP address of PNF (External) Controller	String
Transport Configuration	Transport configuration is given to the PNF.	String
Location	the Location configuration may be given to the PNF. [in A&AI Complex Object association]	String
Software Version	The expected PNF Software Version(s) is given to PNF (Controller reads the Detected PNF S/W version).	software_versions list (array structure)

SDN-R Config Database

SDN-R has a RAN Config Database (MariaDB/MySQL)

- REST API query interface to other ONAP modules – **need swagger API spec asap**
- Used by PCI-H-MS (step 4b) and **OOF (step 7)**
- Put timestamp in API, and figure out history specs later

Attribute	Format
<u>networkId</u>	string
<u>cellId</u>	string
<u>pciValue</u>	integer
<u>nbrList</u>	list of <u>cellId</u>
<u>lastModifiedTS</u>	timestamp

API	Input	Output
Get <u>cellList</u>	<u>networkId</u> , <u>ts</u>	List of <u>cellIds</u>
Get PCI	<u>cellId</u> , <u>ts</u>	PCI Value
Get <u>nbrList</u>	<u>cellId</u> , <u>ts</u>	List of <u>cellIds</u>

SDN-R w/ PnP in R3

SDN-R is ONAP controller derived from CC-SDK that combines functionality of APP-C & SDN-C and includes wireless artifacts.

SDN-R is a sub-project of SDN-C.

“Is SDN-R is a sub-project of SDN-C. If not what is it?”

SDN-R = APP-C for RAN. “ how is SDN-R common to APP-C “

ISSUE:

Concern that SDN-R replicates functions (e.g. SDN-C does IP assignments).

SDN-C configures/creates Networks.

SDC would need to be aware of another SDN-controller, new logic to pass DGs.

ISSUE:

“SDN” implies a networking controller vs an PNF “App” controller

SDN-R app controller for PNF/VNFs vis a vis LCM.

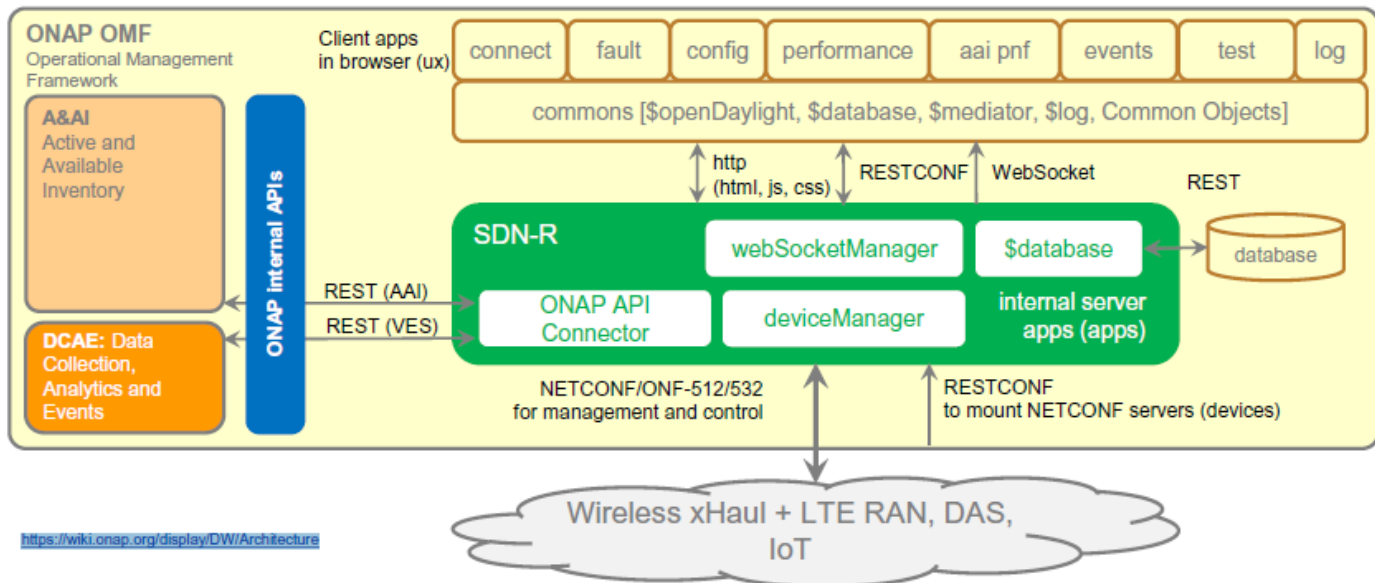

CC-SDK based Mobility Network Function Controller (MNFC) for Mobility/Wireless

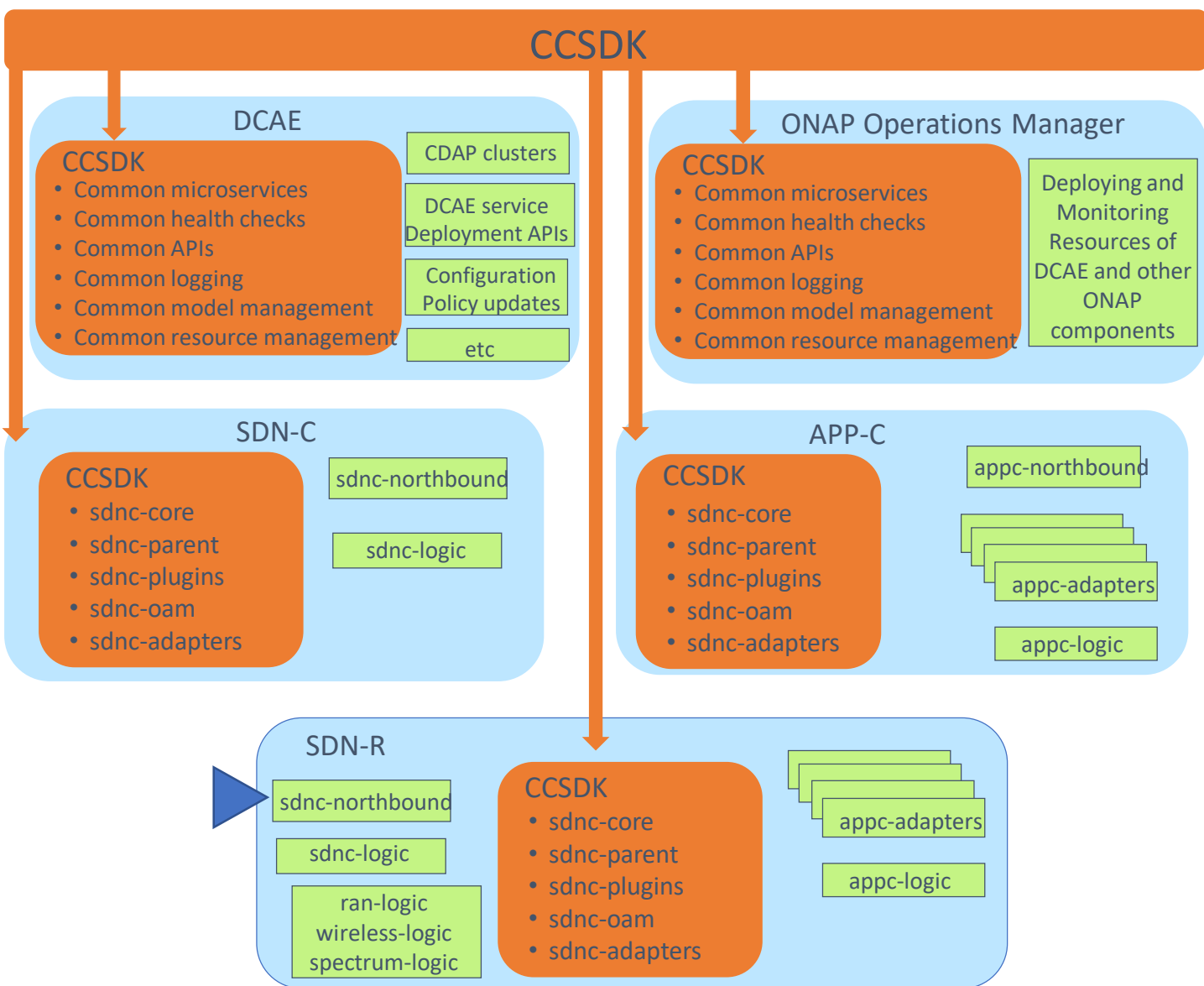

SDN-R

- Evolving to become the one ONAP Controller for Mobility/Wireless PNF/VNF
- Sub-project in SDN-C

SDN-R intended to be a stand-alone controller
Only organizationally is SDN-R a sub-project of SDN-C

SDN-R uses SDN-C Northbound (verify - ?)

SDN-R Device Discovery

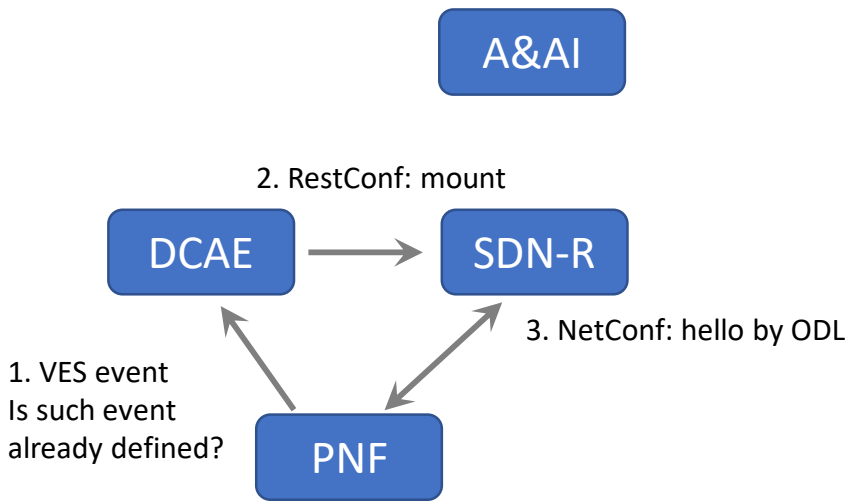

SDN-R Event Flow

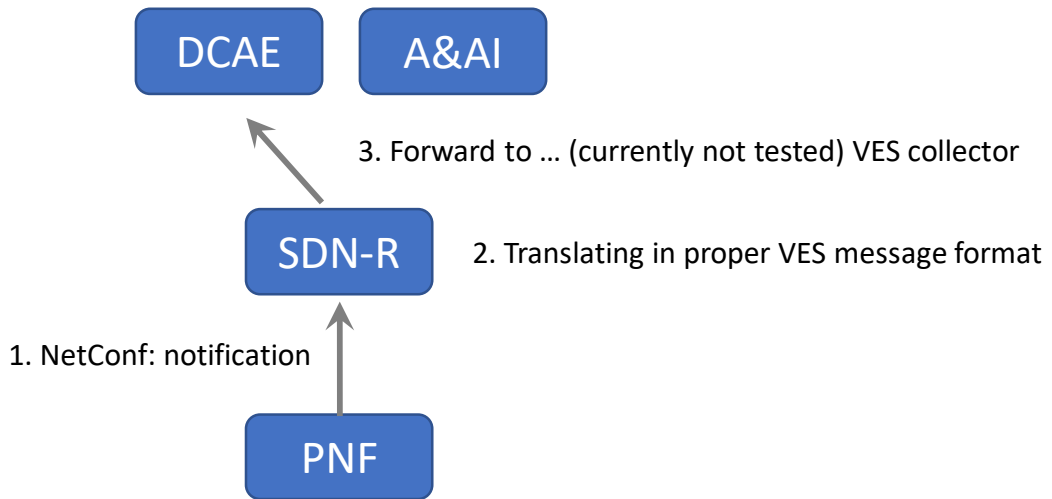

SDN-R A&AI Flow

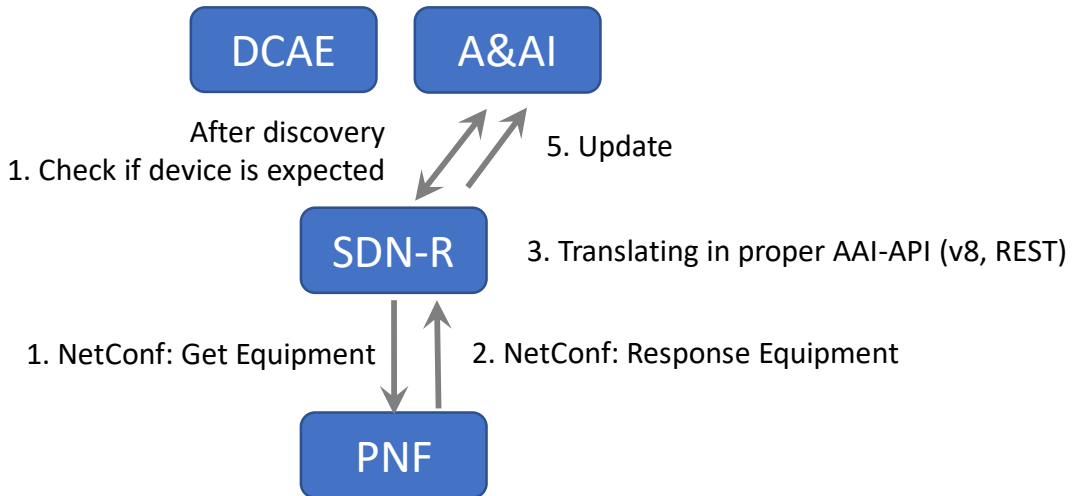



PNF Plug and Play INTEGRATION & SHOWCASING

- ONAP and PNF Plug and Play for 5G RAN
- 5G Use Case Team

PNF PnP Deployment Diagram R3

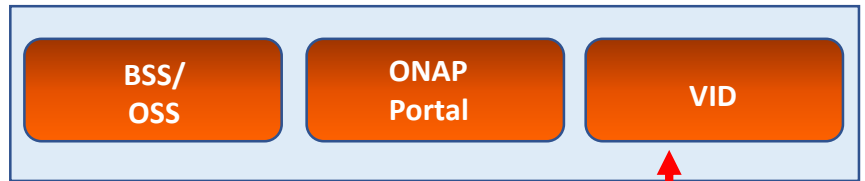

ONAP Deployment

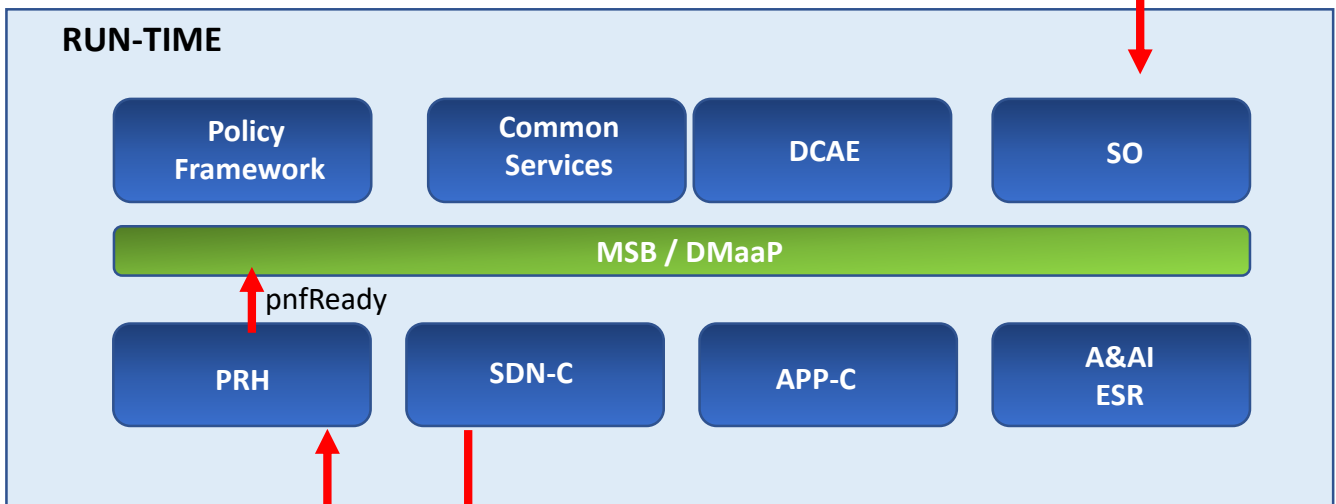
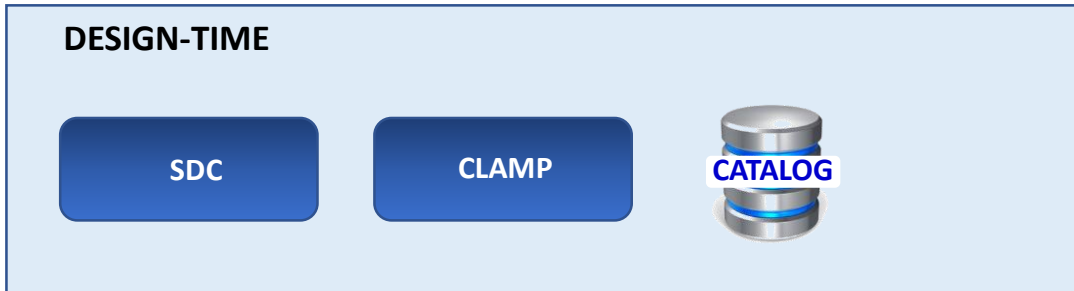

Emulated DU (PNF)

Docker container
Lab – one VM (2 containers)
Cont#1 Sends pnfReg
Cont#2 NetConf Server

Assumption:
 PNF is management accessible through
 Physical connectivity
 To ONAP deployment
 To external provider network

Overlay
 Virtual network
 SRIOV
 VNFs external connectivity

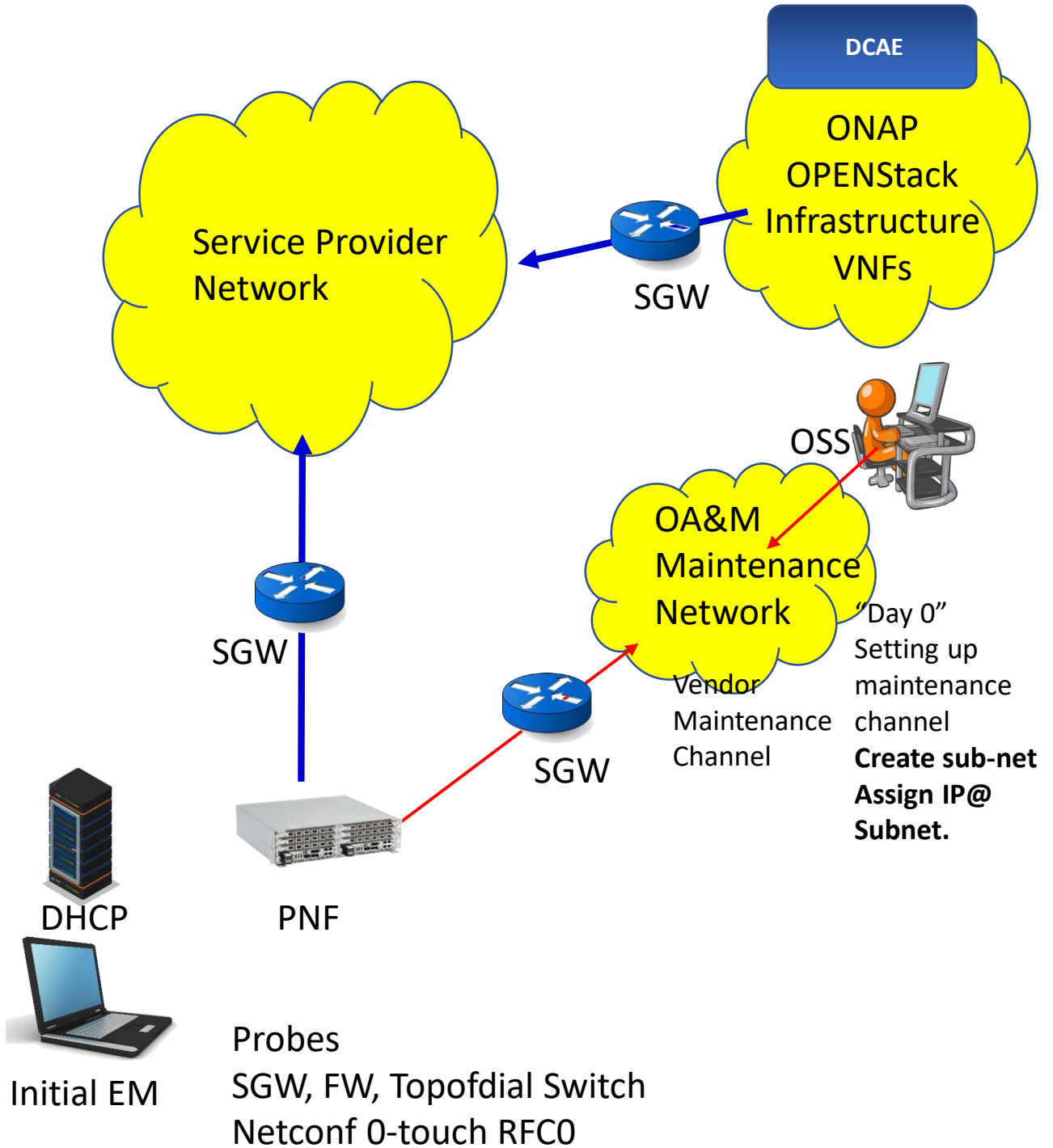

PnP Flow STEP	TEST CASE SECTION	RELEASE
1 Resource Definition	PnP1 Resource Definition	R2 (Beijing)
2 Service Definition	PnP2 Service Definition	R3 (SDC: new PNF model)
3 Type Modeling Artifacts	PnP3 Type Modeling Artifacts	R2 (Beijing)
4 Resource Declaration	PnP4 Resource Declaration	R3 (Alt Operator`s Inventory Management system)
5 Create A&AI PNF Entry	PnP5 Create A&AI PNF Entry	R3 (ibid)
13 ONAP Compliant S/W	PnP13 ONAP Compliant S/W	R2 (Beijing)
15 Work Order to SO	PnP15 Work Order to SO	R3 (SO R2 Integration)
16 Service Instantiation	PnP16 Service Instantiation	R3 (SO R2 Integration)
17 Homing OOF Sniro	PnP17 Homing OOF Sniro	R3 (SO R2 Integration)
18 Resource RLF	PnP18 Resource RLF	R3 (SO R2 Integration)
19 Check A&AI Entry	PnP19 Check A&AI Entry	R3 (SO R2 Integration)
20 Create A&AI Entry	PnP20 Create A&AI Entry	R3 (SO R2 Integration)
21 Subscribe VES Event	PnP21 Subscribe VES Event	R3 (SO R2 Integration)
22 RLF Thread Terminates	PnP22 RLF Thread Terminates	R3 (SO R2 Integration)
25 Authenticates PNF Connection	PnP25 Authenticate PNF Connection	R3 (Casablanca)
26 PNF Registration VES Events	PnP26 PNF Registration VES Events	R3 (pnfRegistration domain)
27 Inventory Query	PnP27 Inventory Query	R3 (pnfRegistration domain)
29 Inventory Query	PnP29 Inventory Query	R3 (pnfRegistration domain)
30 Update PNF Entry	PnP30 Update PNF Entry	R3 (pnfRegistration domain)
31 PNF Ready	PnP31 PNF Ready	R3 (pnfRegistration domain)
34 Update PNF WF	PnP34 Update PNF WF	R3 (SO R2 Integration)
35 Network Assignments	PnP35 Network Assignments	R3 (SO R2 Integration)
36 Configure	PnP36 Configure	R3 (SO R2 Integration)
37 Service Configuration	PnP37 Service Configuration	R3 (controller updates)
38 SO Updates w/ Assginments	PnP38 SO Updates w/ Assginments	R2 (Beijing)
39 Controller Replies	PnP39 Controller Replies	R2 (Beijing)
40 Service Running	PnP40 Service Running	R2 (Beijing)
41 Monitors Service	PnP41 Monitors Service	
42 Inform OSS	PnP42 Inform OSS	

INTEGRATION TEAM IMPACTS

INTEGRATION TEAM IMPACTS

SHOWCASING

DEMO CONTENT – [Closed] What will be **showcased**? Test send registration event. Instantiation Pt1/Pt2 (Update A&AI). PRH service request (VES event & DMaaP topic). APP-C Ansible configure. PNF sends event, receives ansible event. Start with R1 use case (VoLTE / vCPE) upgraded w/ mechanisms of R2. DU Emulator (for registration).

ACTUAL PNF, DU Emulator

DU EMULATOR – [Closed] Nokia will provide a simple DU emulator [Mar 16 2018]. Capable of sending PNF registration request (Step 26, 28). Capable of receive configuration command from APP-C via Ansible (Step 37) and recording result of successful reception (or failure) in a log.

Test Case Description (Demo Document) [Open Point]

(1) **Demo Document** – Document describing demo (use case group?) <https://wiki.onap.org/display/DW/vCPE+Use+Case+Tutorial%3A+Design+and+Deploy+based+on+ONAP+Amsterdam+Release>
 (2) **Test case description** – Documenting the test case. Start with VoltE and modify it.

LOGISTICS (Open Point)

(1) **DEMO ANNOUNCEMENT** – “come see this demo” – Integration ONAP Wiki. Video. Schedule ONAP Wiki Events Calendar. Integration project. (SME = x).
 (2) **LOGISTICS** – *Contacts* Helen Chen, Yang Xu. Intel Windriver Lab, T-Lab (AT&T Lab, Bedminster), and/or use CMCC Lab. ONAP “Open Lab”. ONAP installed in a lab. Demo shown via conference. Virtual Demo (dial in).
 (3) **RELEASE MANAGER** – Coordinate w/ Joe Gildas. Joe Gildas release manager (status of project). M4 Voting.

AUTHENTICAT ION

AUTHENTICATION – Authentication is optional, and for R2 Demo we will not have any authentication. Could be considered for Casablanca (R3). Amsterdam authentication flow not useful for PNFs. Not use second vDHCP & vAAA.

CONTROLLER CONFIGURATI ON

CONFIGURATION: IP address (from DHCP). Username & Password. Configured in controller (manually added to ONAP). VES configuration (do not need username & password to be configured on VES)

DEMO ARCHITECTURE

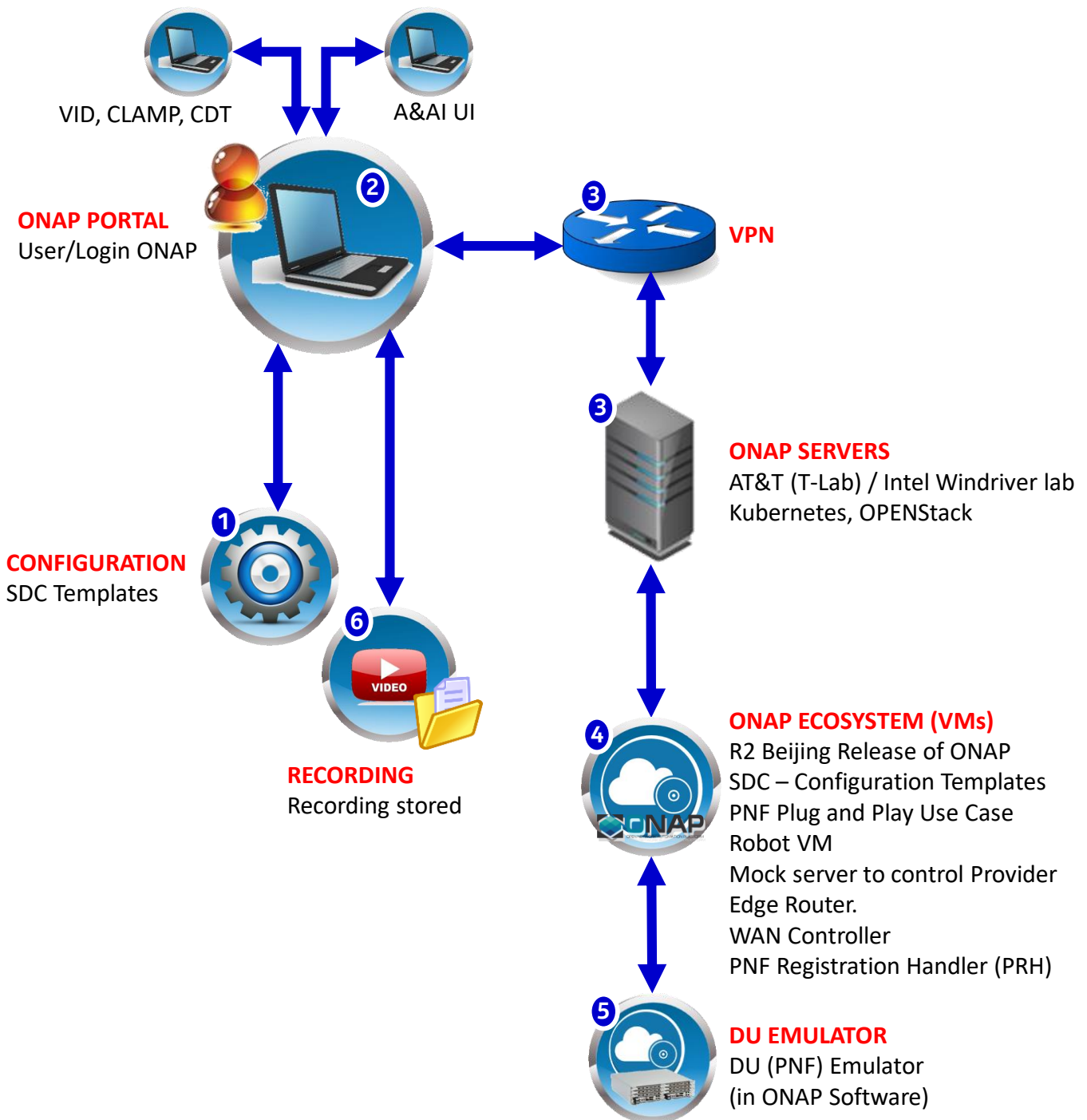

STEP	DESCRIPTION
1	CONFIGURATION – SDC Design templates need to be configured in preparation of the Demo & Showcasing. The appropriate PNF and VNF designs are designed, validated and exported to the other components of ONAP.
2	PORTAL & GUI – The ONAP Portal is used to access the appropriate GUIs and interfaces necessary to operate and configure ONAP. The VID and CLMAP GUI are used to configure the appropriate information for the showcase. The A&AI GUI are used to show the created entries in A&AI for the PNF.
3	VPN – The appropriate security gateways and/or VPN networks are configured. The appropriate security setups are authenticated against. Passwords and IP addresses that are needed to connect to the ONAP servers go through this VPN or security gateway (as appropriate) ONAP SERVERS – The ONAP Servers that host the ONAP ecosystem are connected to
4	ONAP ECOSYSTEM (VM) – The ONAP ecosystem has all of the appropriate Virtual Machines necessary to operate. This has the R2 Beijing Release of ONAP. All of the PNF Plug and Play Use Case updated software is available in the ONAP Ecosystem. The Robot VM, Mock server to control Provider Edge Router, and WAN Controller are established. The PNF Registration Handler a new DCAE plug-in are available in this ONAP ecosystem which is used to register the PNF into ONAP.
5	DU EMULATOR – The DU Emulator is used to emulate the responses and connection to ONAP. The DU emulator establishes a VES HTTPS connection with the PRH during the registration process and receives a APP-C response back via ansible.
6	RECORDING – A recording is made of the showcase and demo for later upload/download and playback for demonstration purposes.

Need a integration details on SDC modeling/CSAR package

PNF Plug and Play ROADMAP (After Casablanca)

- ONAP and PNF Plug and Play for 5G RAN
- 5G Use Case Team

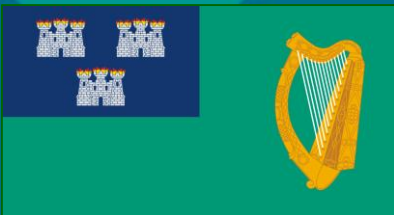



FUTURE FUNCTIONS (Dublin R4)

PnP DUBLIN WORK ITEM	DESCRIPTION
Licensing Management	Having meta-data manage licensing. This at first (in Dublin) might be very simple but can be expanded. Feature activation licensing. Vendor licensing management systems.
VNF & PNF 5G Flow	CU w/ DU - New 5G Sub-Use Case. Interleaving w/ Controller association. MODELLING work to lay ground-work (SA/SD, OO, UML) 5G RAN W/F
PNF Artifacts (PNF Package) & PNF Modeling	In Casablanca we did not get in artifacts in time, and for Dublin we are looking to incorporate actual Artifacts. Some parameters were identified for PNF model and pushed to Dublin for example the Package version.
SO Model Driven	The PNF controller caused quite a stir in Casablanca, the tension between Design/Platform Model vs Run-Time/Deployment Model. As a result the SO controller design was sub-optimal and should be addressed in Dublin
PRH with Actual DU	It would be nice if in Dublin (or Frankfurt) if the Plug and Play Use Case actually worked with a real DU.
Security Enhancement	Security enhancements slated for Dublin will need to be working for PnP Use Case
Software Management	A first step in S/W management was version reporting incorporated into the PNF model. Further or next steps can be taken in Dublin. Software download during installation & commissioning.
NMS as a PNF	Christina (A&AI) had suggested the NMS be modeled as a PNF. This was brought up quite late in the Casablanca development cycle, and even if rudimentarily implemented needs to be further evolved in Dublin
Controller	Controller definition (SDN-C) came so late in Casablanca, we had defined some additional optional parameter for the step37 Service Configuration but likely more evolution needs to be done. SDN-C was not the theoretical proper controller and people objected as this is conceptually the L0-L3 controller.
PRH	There might be more integration or development for the PRH in Dublin.
Integration Casablanca	Experience shows that there are integration things that were often started in the previous release but not yet fully integrated or finished.



FUTURE FUNCTIONS (Dublin R4)

PnP DUBLIN WORK ITEM	DESCRIPTION
VID Enhancement s	<p>#4 – WORK ORDER (Optional) – Supporting Work Order. Supported with service specific applications. Inventory systems (optional). Future extension to ONAP. Interface w/ BSS-OSS systems (API).</p> <p>ACTION: Error cases (check if SDC model parameters != A&AI PNF entry)</p> <p>#5 – VID A&AI INSTANCE CREATION – (optional) (slide 20/Step 4) – VID supporting Resource Declaration a PNF A&AI Instance creation. Similar flow in eCOMP.</p>
5G RAN W/F	Create the <i>5G RAN Work-Flow</i> .
SO support of A&AI creation	<p>A&AI UI can create an inactive PNF A&AI entry.</p> <p>A Service provider might use an inventory system and A&AI UI to create a PNF A&AI entry.</p> <p>In Step #19A instead of EXITING, SO would go into WAIT STATE pending rehydration of RLF w/ pnfReady</p>
SO support for already existing PNF A&AI entry	<p>Support of SO for an already existing PNF A&AI Entry (use case with a deleted & recreated or 2nd service using a PNF)</p> <p>In Step #19B SO would exit and service creation would continue</p>
A&AI pnf-id as INDEX for PNF	Using the pnf-id (instead of pnf-name) as the index for PNF into A&AI. (discussion started in R3, socialized, Contact: Chesla Wechsler)



APPENDIX & Meeting Notes



DISCUSSION MAY 03, 2018

SDN-R supports all 3

CC-SDK controller

Should support all 3

How does that get implemented

PNF agnostic/future-proof

PNFs will support one

ADAPTORS/MEDIATORS

Adaptor – No adaptor

PNF talks directly to ONAP

Adap/transl/mediators

For embedded base.

5G “going native”

PNF – Descriptor

Protocols supports

PNF Package defines

The Meta-models Tbsupported

mm microwave PNF unchanged

ID PNF

PNF #62

SDN-C
UUID

PNF #62

A&AI

Mac Address
IP Address

Correlation ID
(UUID)
PNF #62

Gets Assigned a UUID

Just like any VNFID

From then on processes of ONAP

Work on UUID

CorrelationID is no longer used.

UUID assigned by SDN-C (rules how UUIDs assigned)

DCAE Kubernetes Deployment

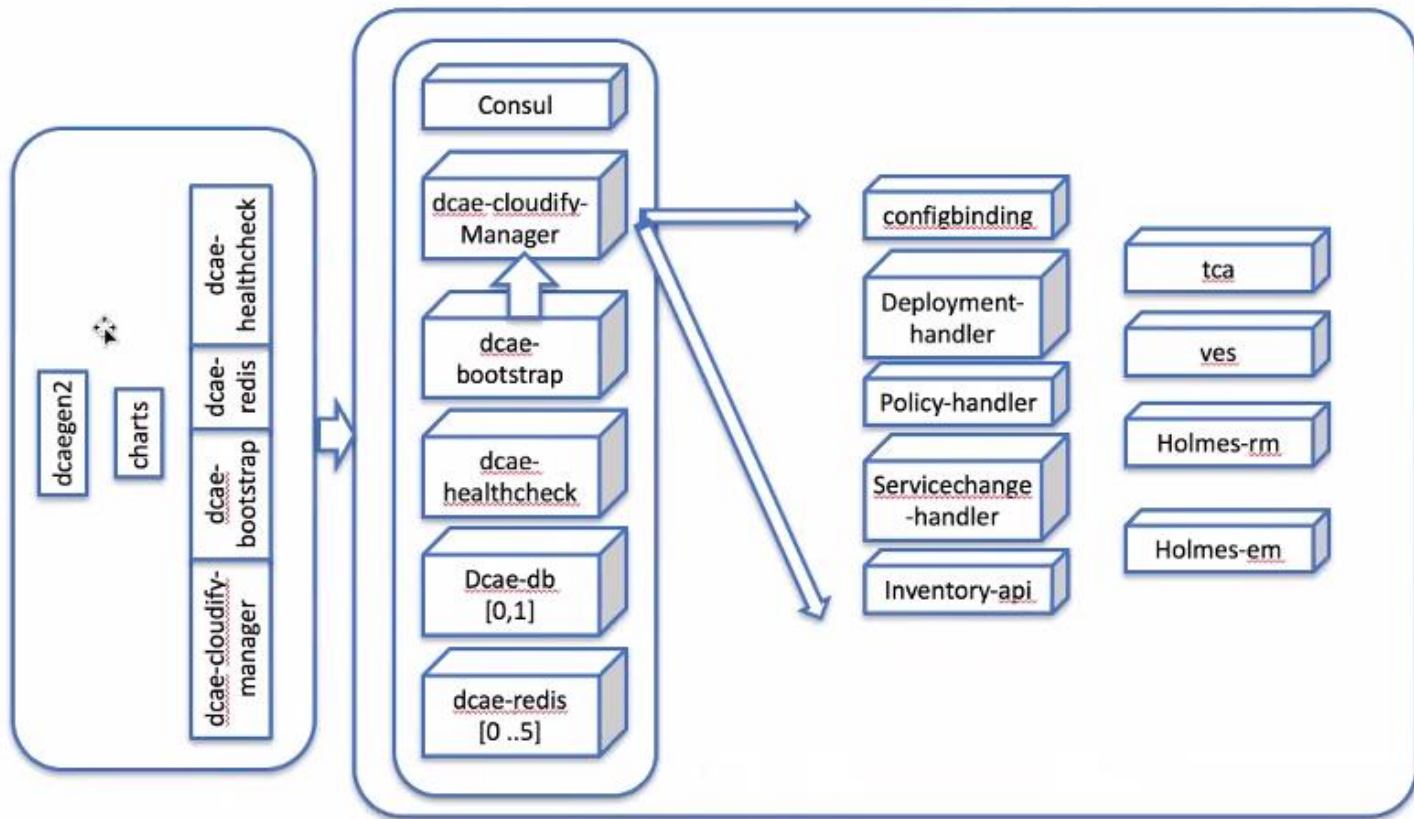

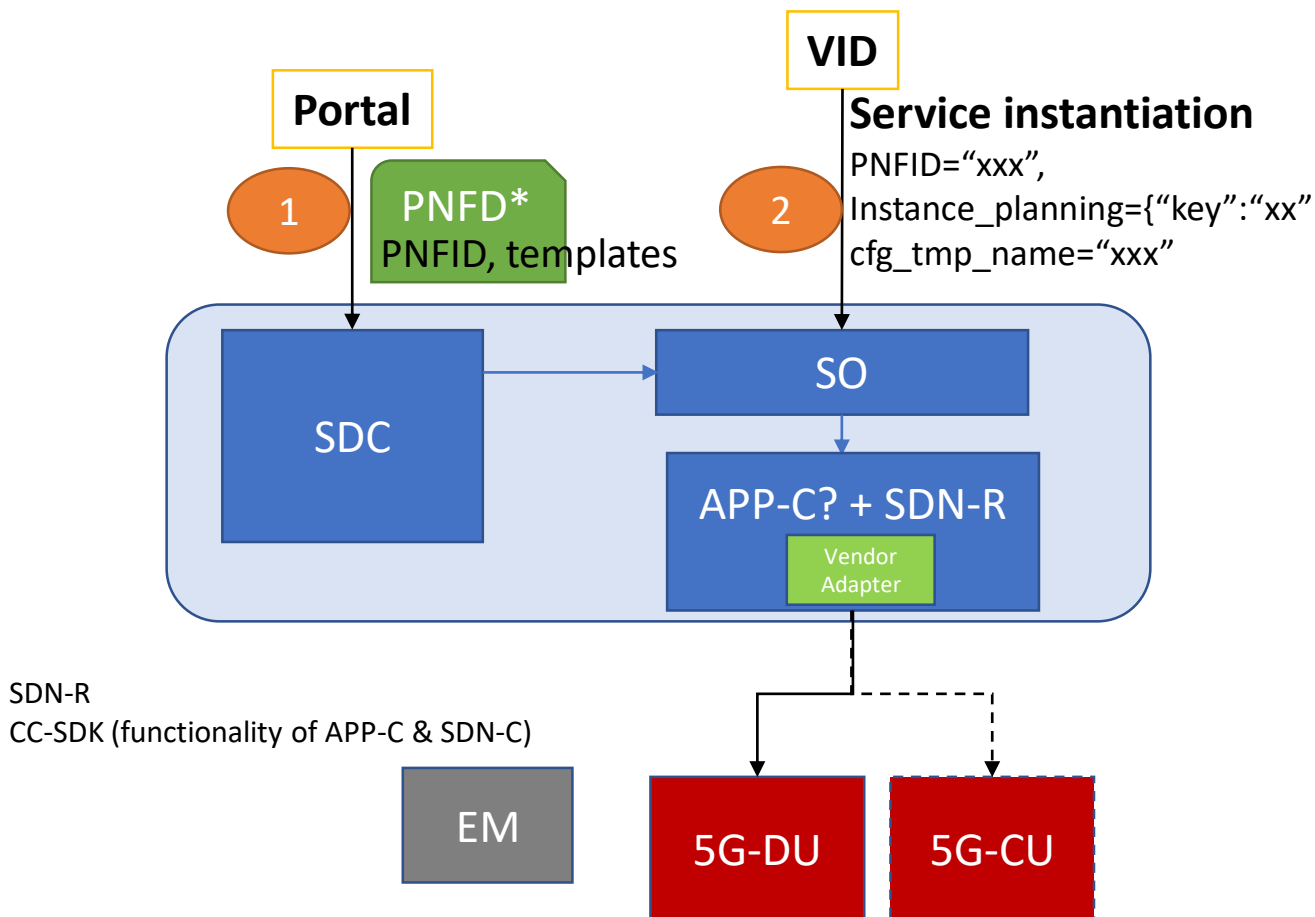

Design time

- (1) Onboarding PNFD
 - PNFID
 - Templates, including PNF/VNF templates,
 - Configuration templates

Run time

- (2) service instantiation
- (3) generate configuration data
- (4) configure PNF/VNF via EM
- (5) CU-DU inter-connect

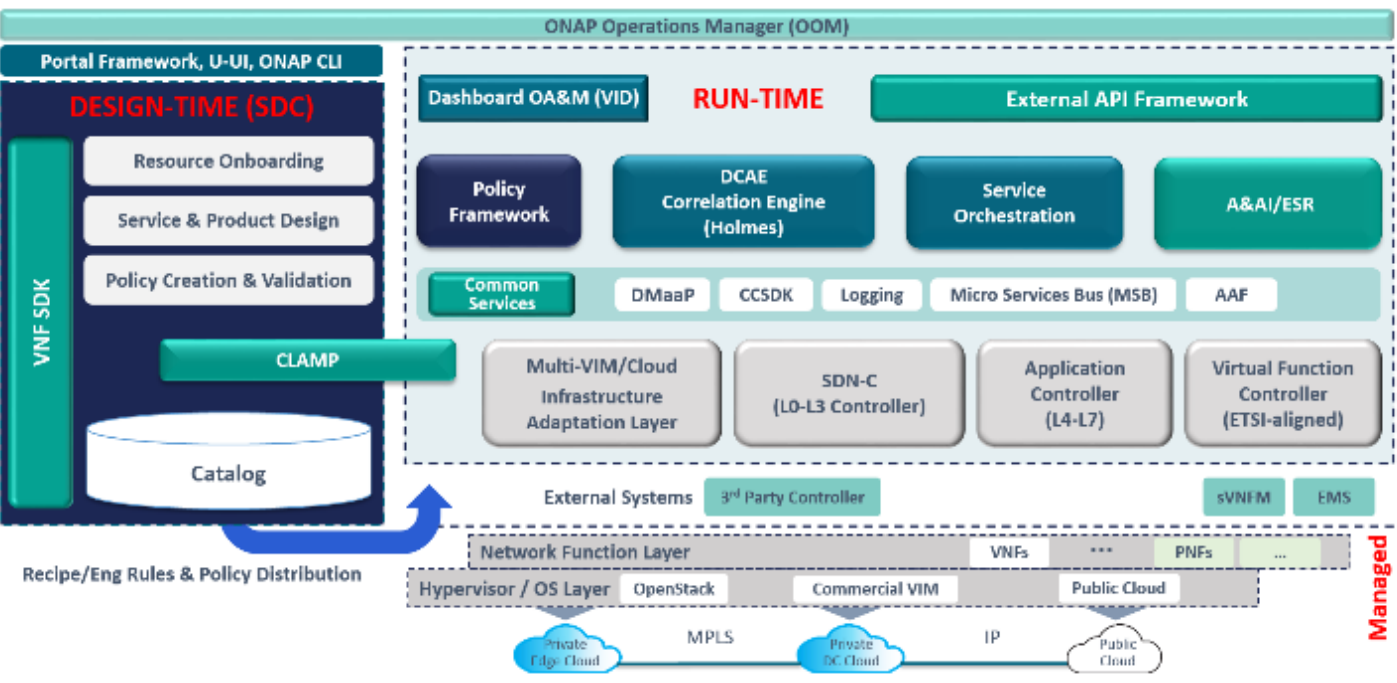
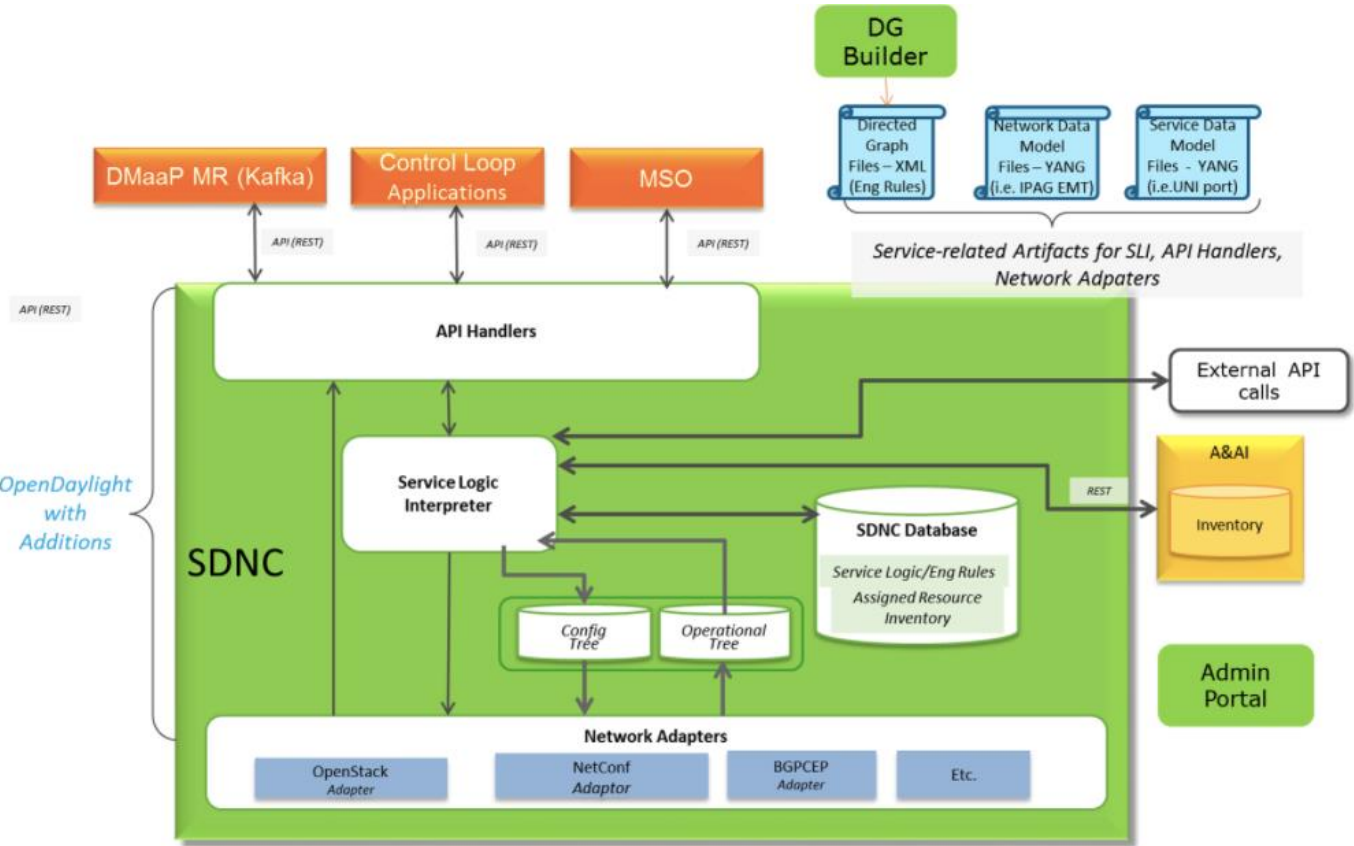

DESIGN TIME

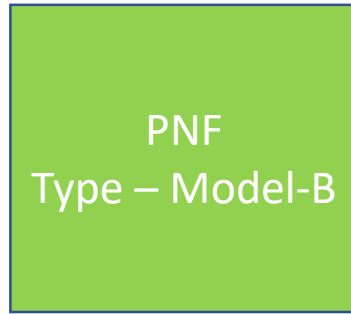

Serial Number = 1234567890

SDC Run-time attribute; optional; expected to be filled in run time

Logical Resources

RUN TIME

A&AI

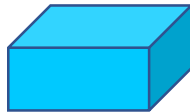
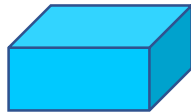
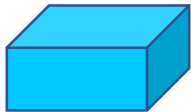

PNF #821

PNF #822

PNF #823

PNFB #824

PNFB #825

Serial Number

Serial Number

Serial Number

Serial Number

Serial Number

Physical Infrastructure

SAMPLE YAML FAULT DEFINITION

```
event: {presence: required, action: [ any, up, overTemperature, RECO-rebootPnf, null ],
structure: {
  commonEventHeader: {presence: required, structure: {
    domain: {presence: required, value: fault},
    eventName: {presence: required, value: Fault_Nokia_5GCU_Overtemperature},
    eventId: {presence: required},
    priority: {presence: required},
    reportingEntityName: {presence: required},
    sequence: {presence: required},
    sourceName: {presence: required},
    startEpochMicrosec: {presence: required},
    lastEpochMicrosec: {presence: required},
    version: {presence: required, value: 3.0}
  }},
  faultFields: {presence: required, structure: {
    alarmCondition : {presence: required, value: Overtemperature},
    eventSeverity: {presence: required, value: MAJOR},
    eventSourceType: {presence: required, value: BaseStation},
    faultFieldsVersion: {presence: required, value: 3.0},
    specificProblem: {presence: required},
    vfStatus: {presence: required, value: "Active"}
    alarmInterfaceA : {presence: required},
    additionalInformation: {presence: optional, array: {
      keyValuePair: {presence: required, structure: {
        key: {presence: required, value: Temperature},
        value: {presence: required}
      }
    }
  }
  }
  }
}
```

VES FAULT EVENT (faultFields)

Field	Type	Required ?	Description
alarmAdditional Information	hashMap	No	Additional alarm information (note: for SNMP mapping to VES, for hash key use OID of varbind, for value use incoming data for that varbind)
alarmCondition	string	Yes	Short name of the alarm condition/problem, such as a trap name. Should not have white space (e.g., tpLgCgiNotInConfig, BfdSessionDown, linkDown, etc...)
alarmInterfaceA	string	No	Card, port, channel or interface name of the device generating the alarm
eventCategory	string	No	Event category, for example: 'license', 'link', 'routing', 'security', 'signaling'
eventSeverity	string	Yes	Event severity enumeration: 'CRITICAL', 'MAJOR', 'MINOR', 'WARNING', 'NORMAL'
eventSourceType	string	Yes	Examples: 'card', 'host', 'other', 'port', 'portThreshold', 'router', 'slotThreshold', 'switch', 'virtualMachine', 'virtualNetworkFunction'
faultFieldsVersion	number	Yes	Version of the faultFields block
specificProblem	string	Yes	Description of the alarm or problem (e.g., 'This event is sent when the LG is asked to perform a location for a CGI that is not in its configuration')
vfStatus	string	Yes	Virtual function status enumeration: 'Active', 'Idle', 'Preparing to terminate', 'Ready to terminate', 'Requesting Termination'

Approach for RAN Simulator

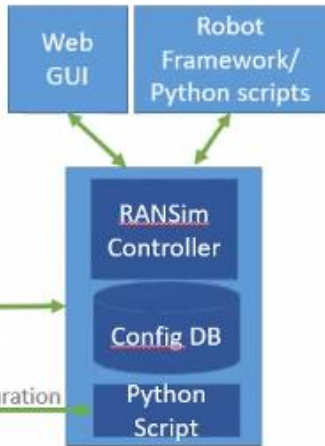
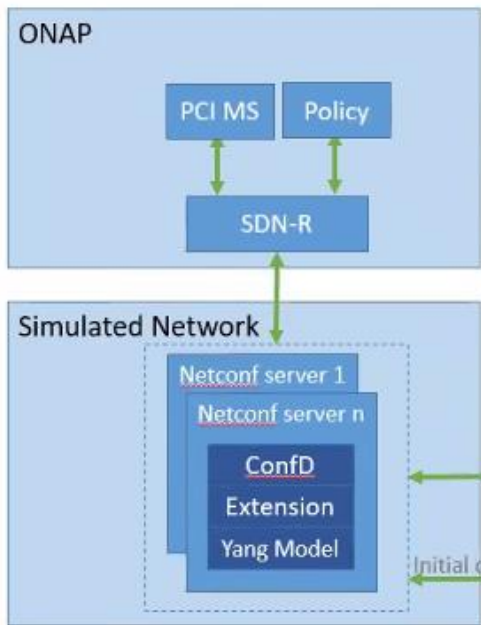

- Simulated Network
 - Yang model defined by SDN-R module will be used for simulation
 - ConfD Basic Netconf Server will be used to simulate the RAN. C-API extension will be used to update the *phy-cell-id* values, to send *ran-neighbor-list* changes
 - Each netconf server will run as standalone process or Docker container
 - The netconf servers will be spawned by RANSim Controller based on the topology specified.
 - Python scripts and client will seed the initial configuration for each Node.
 - Each netconf server can send a mount request to SDN-R when they are spawned.
 - *ran-neighbor-list* update notification will be sent by netconf server to SDN-R based on the trigger from RANSim Controller
 - Will be able to accept *phy-cell-id* update trigger from SDN-R and forward same to RANSim Controller

Network Service Descriptor Model - Based on R2

创建: Jessie S Jewitt, 最新修改于: 八月 24, 2018

<https://wiki.onap.org/display/DW/Network+Service+Descriptor+Model+-+Based+on+R2>
<https://wiki.onap.org/display/DW/PNF+resource+IM+proposal>

Stage 5: PNF Activation Steps (ONAP)

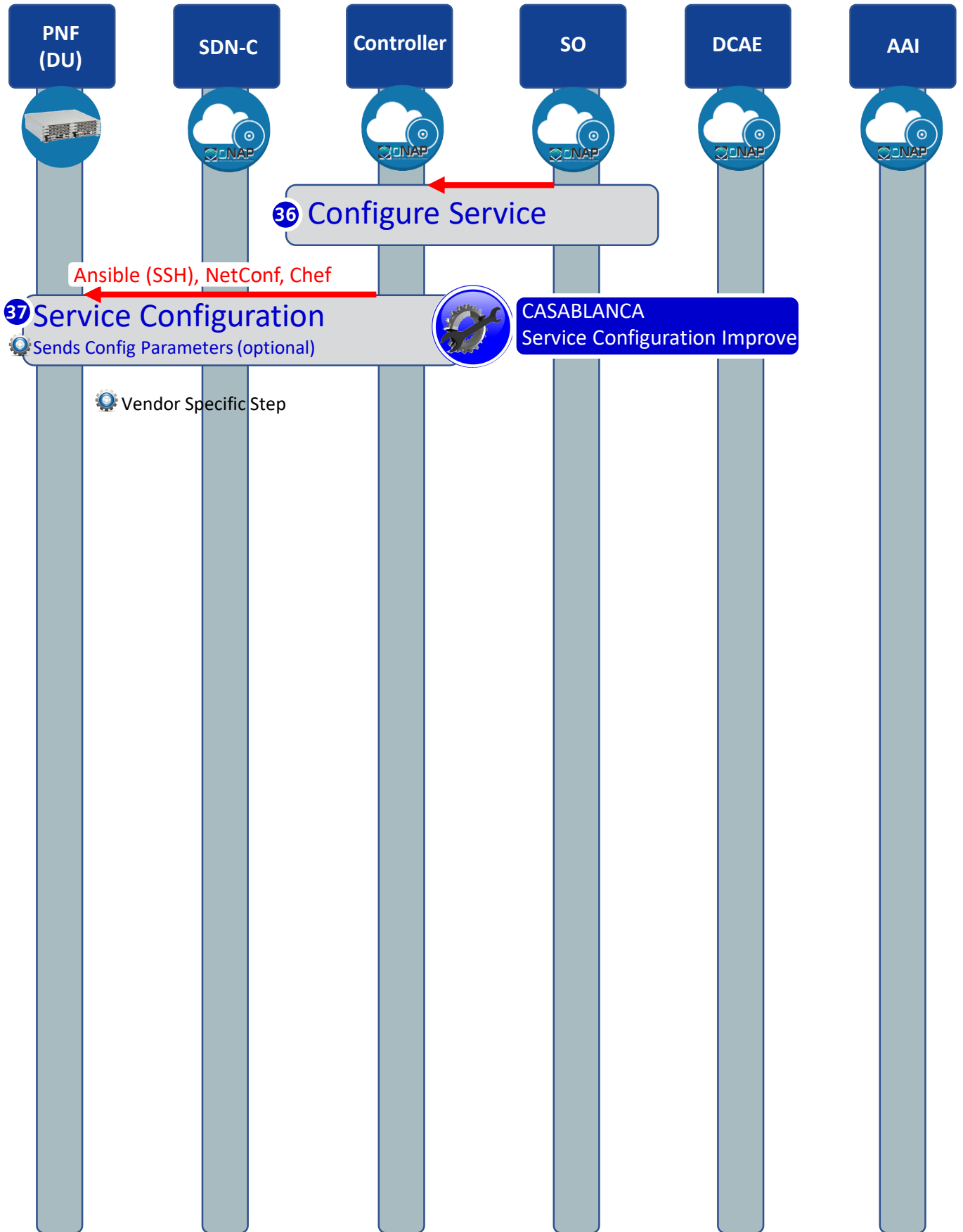

- 1. PM, FM EVENTS CACHE** - Info before pnfRegistration has Completed. CFAM. No FM upload. If Mplane connectivity, BTS queues until event is open. BTS queues events until connection is available. Dependency pnfReg start/stop & other VES events. Service is created, BTS started. A&AI entry. BTS is already sending FM. Customer pnfReg msg. Plan file. End points for FM, PM, PNFReg. (Long Term) [If FM/PM end-point is configured, the BTS can send FM/PM VES events](#). It is expected that the FM/PM end-points wouldn't have been configured until PnP is completed. In 5GC20A/B we will be using NetAct. Step 37 configuration would send the PNF the FM/PM endpoint. Michel FM will come in 5GC20C (Sept 2020). Q: Req: If not successfully registered. Lose connection, buffer? A: No. Drop info. FIFO. ONAP ignores missing files. Only report files still present. Long-Term: ONAP will perform Alarm sync w/ PNF. [COAM BTS SOLUTION: No special logic, as long as FM/PM VES endpoints are configured in Plan file it will send, otherwise it will not send.](#)
 1. [SUNNY](Step#1) Nokia PNF registers with PnP (Step#1) PNF FM/PM wants to send. (Step#2) Finish PnP (Step #2) PNF sends up PM/FM info cached.
 2. [RAINY](Step#1) Nokia PNF register (Step#1) PNF FM/PM wants to send. (Step#2) PnP FAILS (Step #2) PNF sends up PM/FM info cached (drop, keep it cache).
 3. [VERY RAINY] PNF never completes PNF PnP.
- 2. STOPPING REGISTRATION** – Step 37 is used as a trigger to stop pnfRegistration. Ansible, NetConf. Do nothing ... sending pnfRegistration (until S/W ready to code Ansible/NetConf). pnfReg frequency configurable (?) in Plan file or hardcoded. pnfRegistration Frequency to 30 seconds/default. Periodicity delay. Max Period = 1xday. Pre-config period (PnP). VES End point Heart-beating VES Event. No NetConf Server required. Socket server to reply. pnfReg send a ACK. [COAM BTS SOLUTION: Send pnfRegistration VES events periodically. The period is configurable defaults to 30 seconds. Escalation strategy is to double the periodicity \(3 attempts\) until a MaxTryPeriod is reach = 1x day. Parameters Names \(4\).](#)
- 3. STEP 37 FAILURE** – if there is no response back from the PNF trying to do Step 37, will ONAP consider PnP a failure, if there is no reply back from the PNF. PNFReq#-5320, 5330, 5340. 5G20B implement Step 37. [SOLUTION: Recommendation to AT&T working with Nokia BTS in 5G20A is when creating the PnP flow from the Building blocks that you don't have svc configuration \(step 37\). BB-ID. Assign names. Select BB & sequence. Macro workflows hard-coded in flow.](#)
- 4. H/W CHANGE (REREGISTRATION)** – PNF has changed physically. ID, MAC. PREVIOUSLY registered with ONAP. Re-registration Epic. "New PNF". How does ONAP clean out the "Old PNF". Decommission step? Serial #. ONAP problem. ONAP operator should "decommission" the PNF. [Life-cycle management topic](#). BTS is down, people go to site. System module is down, change system module (CPU), load S/W, on-site (WebEM/WebUI), bring BTS w S/W & Plan file. The "same" MRBTS. NOK+Serial#. Mod#1=123456 ; Mod#2=567890. Hardware change PnP Re-registration U/C. [SOLUTION: 1. BTS1 registers 2. BTS1 finishes pnfReg 3. BTS1 breaks 4. ONAP decommissions BTS1. 5. BTS1 > H/W changes > BTS2 6. BTS2 registers anew.](#)
- 5. STANDBY TO ACTIVE SYSTEM MODULE** - 2 system modules, active-standby mode. One module in standby. Standby switches to active. Separate M-plane. Dual Asik (primary/secondary). DU#1, DU#2. Classic BTS (5GC20A). Two system modules, but only the "active" is visible. For this to work, BOTH system modules need to be visible to ONAP. To provide two correlation IDs. Two PNFs. STATE CHANGE reflected in ONAP. Disabled & Active. X.703 TMN. OPER State.
- 6. PNP CONFIGURATION** – DHCP Discover, 802.1x. Vendor proprietary fields. Step 37 Configuration message to the PNF. FM/PM IP@ VES Endpoints.

SON Lifecycle – Cell addition/configuration

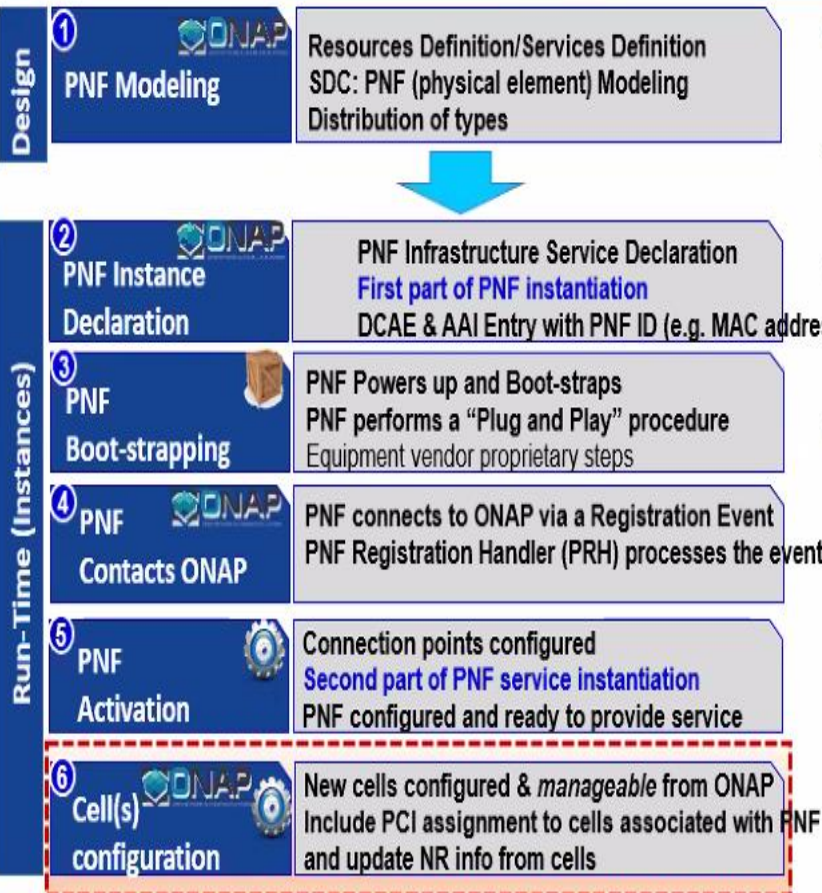

- New cell addition by ONAP – extend PNF Plug-and-play use case
- Assign initial PCI value (and other configurations?)
- Explore use of *building blocks* to reuse functionality of cell configuration during PNF onboarding, as well as later
- Points for further analysis and discussion
 - Modeling of RAN “Cell” in ONAP
 - ‘Discovery’ of a new cell (provided by PNF?) and subsequent configuration (by ONAP?) before it is active; removal of a cell (dis-associate from PNF)
 - Handle “Shared” cells
 - O-RAN alignment
 - Cell discovery, initial configuration, new cell addition/removal later, initial PCI assignment
 - Initial NR details update in ONAP (topology discovery?)

pnf-registry

DCAE PNF PnP – main use-case components

- Service Design & Creation (SDC)
 - PNF Onboarding
 - Service PNF Design
- Virtualized Infrastructure Deployment (VID)*
 - Triggers SO to instantiate a Service, based on model containing a PNF
 - Passes PNF-specific correlationID to SO
 - *)Optional element - Native SO API could be used as well (it is used in csae GR API test)
- Service Orchestration (SO)
 - Instantiates a Service
 - Creates a PNF resource instance, based on correlationID
- DCAE platform
 - Collects the PNF registration message, using VES collector
 - Processes the registration, updating the PNF details, using PRH
 - Triggers the SO to activate the PNF instance in a service
- Active & Available Inventory (AAI)
 - Stores/Updates the Service and PNF instance details

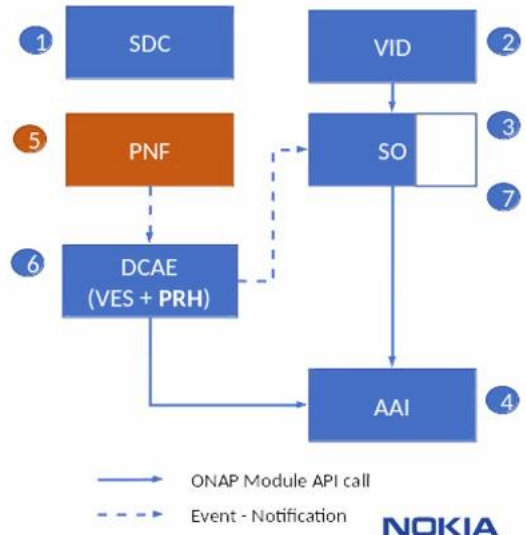

pnf-registry

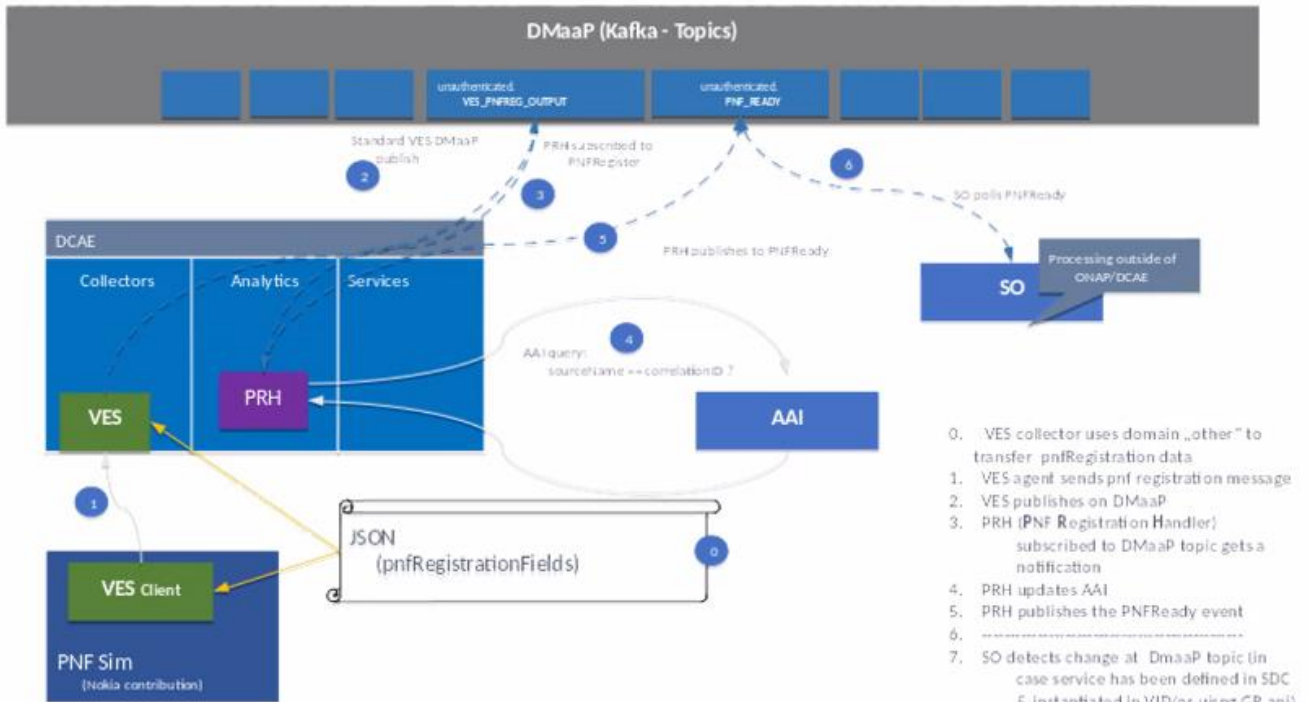

0. VES collector uses domain „other“ to transfer pnfRegistration data
1. VES agent sends pnf registration message
2. VES publishes on DMaaP
3. PRH (PNF Registration Handler) subscribed to DMaaP topic gets a notification
4. PRH updates AAI
5. PRH publishes the PNFReady event
6. -----
7. SO detects change at DMaaP topic (in case service has been defined in SDC & instantiated in VID/or using GR api)
8. SO is notified to complete resource instantiation