



# ONAP Casablanca Developer Forum Summary

- Conference Summary Slides

Benjamin Cheung

Jun 27, 2018 version 2

# PRESENTATION GROUPINGS

- **USE CASE PRESENTATIONS**
- **ONAP COMMUNITY & PROCESSES PRESENTATIONS**
- **INTEGRATION TESTING & VALIDATION PRESENTATIONS**
- **SERVICE PROVIDER PRESENTATIONS**
- **ONAP PROJECTS PRESENTATIONS**
- **ONAP DEPLOYMENT PRESENTATIONS**
- **SOFTWARE DEVELOPMENT PRESENTATIONS**
- **MISCELLANEOUS TOPICS**



# USE CASE PRESENTATIONS



**FILE: 5GucCasablancaSummary-06192018.pptx**

# Casablanca Platform Enhancements to Support 5G Use Case

Summary of Planned Enhancement Areas

5G Use Case Team

June 14, 2018

# PNF PnP Enhancements

TOPIC	DESCRIPTION
<b>PNF Registration Handler (PRH) enhancements</b>	Define a New VES Event Domain for PNF registration with the corresponding support in DCAE VES Collector, DMaaP and PRH
<b>SO Workflow enhancements</b>	Enhance SO to support model driven dedicated workflow for PNF elements
<b>Service Configuration Enhancements</b>	Add needed artifacts in CCSDK to support Radio / Microwave configuration, PNF discovery and registration support
<b>Security enhancements</b>	Authentication and Certificate support for PNF, including registration event and data collection (fault and performance)
<b>Modeling enhancements</b>	Enhance ONAP information and data model to fully support 5G PNF elements, including inheritance and PNF sharing characteristic
<b>PNF onboarding and packaging</b>	Define PNF Package, PNF package validation and onboarding enhancements

# Service Configuration Enhancements

TOPIC	DESCRIPTION
<b>Enhance CDT tool to support 5G and integrate into SDC</b>	Integrate App-C focused CDT tool into SDC and enhance it to support 5G network elements and integrate with L1-7 GNFC
<b>Capture and Verify PNF Software version</b>	Enhance GNFC to capture and verify PNF software version, Enhance A&AI to store PNF Software version
<b>PNF &amp; CU Application Level Configuration</b>	Generate a single ONAP controller persona from CCSDK (called GNFC) to support various 5G network elements (Layer 1 through 7 configuration and management)
<b>Lifecycle management Support</b>	Enhance change management and Close Loop Automation (CLAMP) to support 5G PNF / VNFs

# Performance Analysis & Optimization

TOPIC	DESCRIPTION
<b>Bulk performance measurement (PM) data collection</b>	Enhance DCAE VES collection layer to support periodic (e.g. every 5 to 15 minutes) bulk data collection from VNFs and PNFs. Support both file-based collection and mapping to VES Events for chosen file content
<b>High Volume and Near Real-time streamed data collection of Performance measurements</b>	Enhance DCAE performance measurement (PM) data collection to support near real-time (order of seconds) data. Introduce a high-volume VES collector using a persistent connection (TCP socket), support a new data encoding (GPB). Distribute DCAE collection at the cloud edge (for scalability)
<b>High Volume, Near Real-time streamed data collection using connection-less pub-sub mechanism</b>	Enhance DCAE performance measurement (PM) data collection to support near real-time (order of seconds) data. Introduce a high-volume VES collector using a connectionless pub/sub mechanism (DDS technology), support a new data encoding (GPB). Distribute DCAE collection at the cloud edge (for scalability)

# Optimization Framework Enhancements

TOPIC	DESCRIPTION
<b>Optimal placement of vNF</b>	Placement of Mobility Virtual Network Elements (CUs) across the highly distributed edge clouds is a fundamental requirement. Service Providers must also optimize the performance of the 5G RAN in real-time.
<b>Optimization problem formulation</b>	Ability to model the problem as a constrained optimization problem, that is driven by policies – Potential use case examples: formulation of optimization problems at various levels: Customer (e.g. provisioning), Service (e.g. slice optimization ), Network (e.g. Routing, problems at the network planning level), Infrastructure (e.g. Placement) & Resource (e.g. License)
<b>Optimization problem solving</b>	Ability to use and deploy appropriate analytics, algorithms and solvers to solve the problem in acceptable time frames at various levels: Customer, Service (e.g. Slice Optimization Analytics), Network (e.g. SON network planning analytics), Infrastructure (e.g. Placement) & Resource





**FILE: PNF PlugnPlay CasablancaDevConf 14Jun2018 v7 (PDF)**







# ONAP PNF Enhancements for Casablanca (R3, 4Q 2018) Casablanca Developer's Conference

## 5G Use Case Team

ONAP Casablanca Developer Forum

June 14, 2018

# PNF Enhancements Casablanca Summary

TOPIC	ICON	DESCRIPTION
<b>PNF Registration Handler (PRH) Improvements</b>		New VES Event domain for PNF registration with corresponding support in VES collector, DMaaP and PRH.
<b>SO Workflow enhancements</b>		Introduction of dedicated 5G use case work-flow. Integration of PNF PnP workflow.
<b>Service Configuration Improvement</b>		Service configuration improvements from Controller to PNF after PNF registration to PRH
<b>Security Enhancements</b>		Enhancements for secure communications between NFs and ONAP and between ONAP components. Details will be covered in the Security Subcommittee presentation.
<b>Modeling enhancements</b>		Modeling enhancements to support 5G PNF in ONAP. Inheritance, and PNF characteristics for sharing. Focusing on PNF connectivity. PNF-SDK.
<b>PNF Onboarding / Package</b>		Defining <i>PNF Onboarding Package</i> . Extending framework to work with PNFs. Defining PNF Package framework.



**FILE: Real Time PM Beijing ONAP Conference 20Jun2018 (PDF)**

# ONAP Evolution to support High Volume Data in DCAE to support Real Time PM

## 5G Use Case Team

ONAP Casablanca Developer Forum

June 14, 2018

# Real Time Performance Management (PM) Data Delivery to ONAP

## PROBLEM STATEMENT

*Transmission of specific configured PM data which is time sensitive, delivered at frequent intervals, (less than one minute) from many producers to a single entity (DCAE)*

## PROPOSED SOLUTION: GPB OVER TLS/TCP

- GPB and TCP/TLS are lightweight
- GPB is an effective way to encode the data
- TCP and TLS are broadly accepted and widely used; TCP is efficient way to transmit data
- TLS adds security, when needed, at modest overhead.
- TCP/TLS provides reliable transport with security
- TCP has built in error correction, flow control, congestion control, scaling...
- Caching/Persistency is not critical as data loses relevance quickly.
- Evolution of the existing architecture.

## NEW HVMEAS VES EVENT

- NF sends Real Time PM data to DCAE via a new hvMeas event encoded as message length + GPB binary and streamed via TCP Sockets for efficiency with TLS for security when needed.
- GPB Binary contains two sets of fields: Common Header with the same fields as defined for JSON events for consistency(slide 10) and payload—in this case RTPM(slide 11).
- Each high-volume domain will have it's own GPB schema for the payload.



**FILE: 6.18\_ONAP CCVPN UseCase proposal. pptx**

# CCVPN use case proposal

(Cross Domain and Cross Layer VPN)

CMCC, Vodafone, Huawei

# CCVPN Use Case Summary

## ONAP Peering Orchestration Between SPs

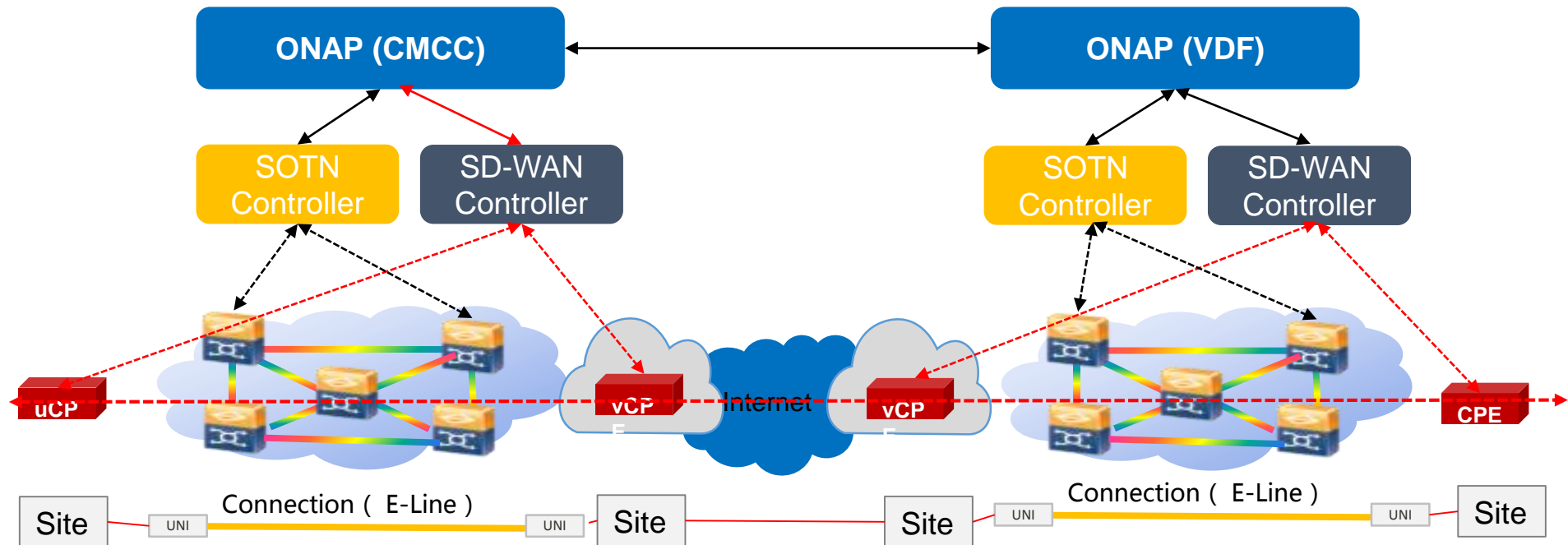

The Final Goal of CCVPN use case is to realize connections between different ONAPs. We plan to demo Joint CCVPN PoC in ONS-EU in Sep.



**FILE: 621 Joint Seech Final Version (PTX)**

# Casablanca Release Developer Forum Joint Speech on CCVPN Use Case

CMCC

Vodafone

Huawei

# Use case: Single Domain OTN Orchestration

## Single Domain OTN Orchestration

A single domain is orchestrated by ONAP.

- OTN topology display
- Service onboarding
- Service design
- Service deployment
- Self-service portal

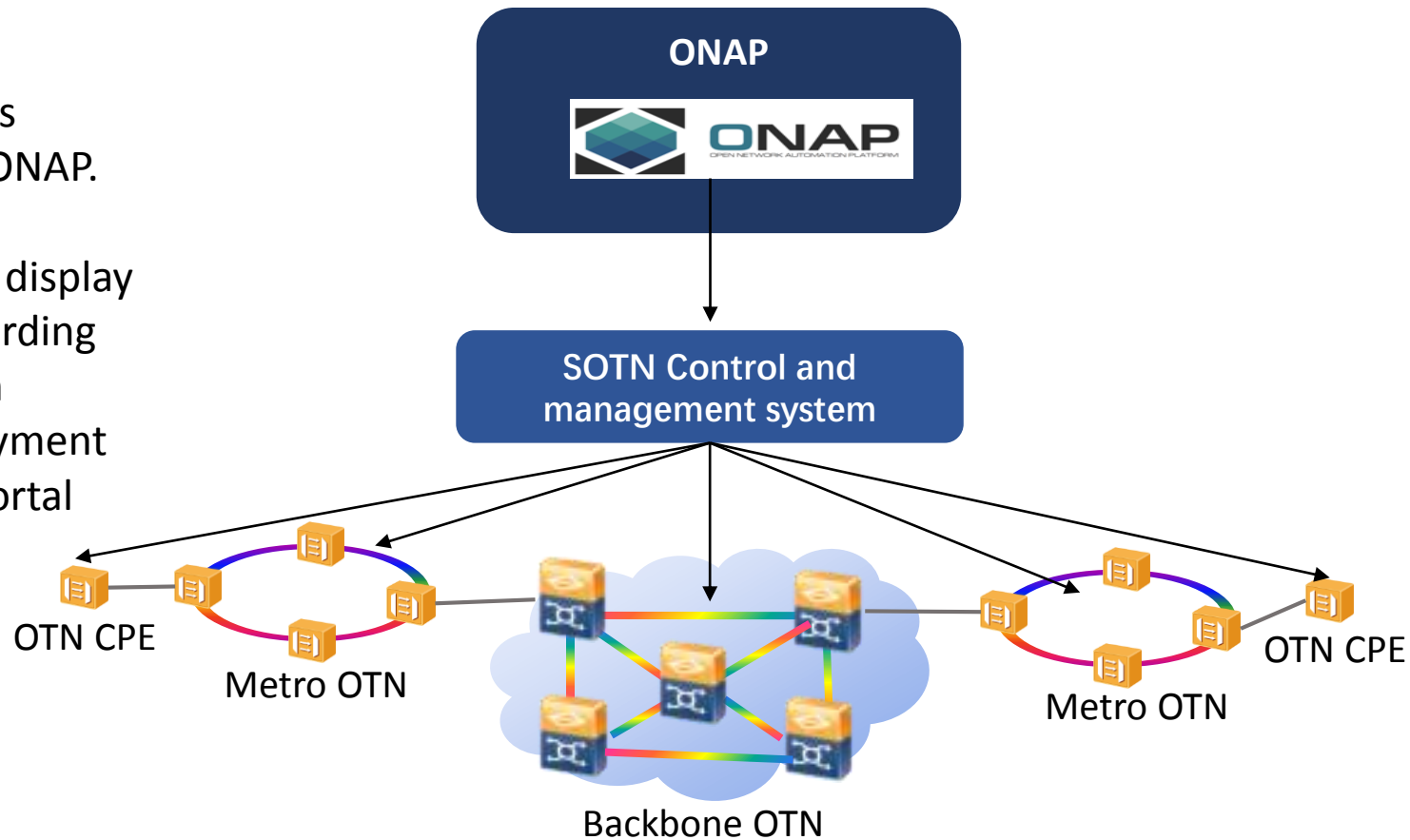





**FILE: 20180619-OpenSourceAccessManager (PDF)**

# OSAM Use Case (Open Source Access Manager)

OSAM Use Case Team

ONAP Casablanca Developer Forum

June 19, 2018

# OSAM MVP Target (Casablanca rel.)

- **Portal:**

- OSAM-UI dashboard - Operational tools for management and visualization of a service instance; Web portal for ONU/OLT topology, ONT/OLT usage and configuration visualization

- **SDC (Modeling):**

- Access peripheral POD PNF package / onboarding
- Access peripheral POD PNF Discovery, registration
- Access peripheral POD PNF configuration via NETCONF/Yang (e.g. BBF TR-383, WT-385)
- Define NSD for Access peripheral POD connectivity

- **SO/Policy/OOF:**

- Cross-domain service orchestration (access, transport, cloud)

- **AAI:**

- Inventory of POD/OLT Ports in AAI

- **External API:**

- Support top down customer service provisioning, BSS service order

- **APPC:**

- Access peripheral POD Lifecycle Management –Change management-software upgrades;

- **DCAE:**

- Transformation and Publish Metrics/events/alarms to ONAP – VES Agent/Collector
- PNF telemetry data collection via DCAE (and event correlation) – what events/alarms and frequency
- Local Analytics in the POD (Distributed DCAE) - **stretch goal**



**FILE: Casablanca Scale Out Use Case 180614 v3 (PDF)**

# Scaling Use Case

## Casablanca

ONAP Casablanca Developer Forum

June 19, 2018

# Auto Scale Out Use Case

	Scale Out	Scale In
Manual Scaling	Beijing <i>(In Progress)</i>	Dublin
Auto Scaling	Casablanca	Dublin

## Scale In Complexities

- Must not impact service
- Drain/Migrate existing traffic
- Transfer state of old instance
- May need to create VNF state machine and state transitions (Idle/Active)

## Description

- Dynamically add instances of a VNFC to address increased loads and bottlenecks within the VNF.

### • Business Requirement

- Operators require this use case to achieve the resource efficiencies promised by cloud computing

### • Supporting Companies

- AT&T

### • Demo VNFs

- vDNS

### • Impacted Projects

- AAI, APPC, CLAMP, OOF, POLICY, SDC (Modeling), SDNC, SO, VID

## Scaling Features for Future Releases

- Scale In
- Scaling TOSCA-based VNFs (Dublin)
- VNF Level Scaling
- Scaling across Datacenters
- Scaling in reaction to other events such as ordering
- Vertical Scaling
- Integrate use of WorkFlow Designer (Dublin)



**FILE: ONAP CM Casablanca Functional Requirements 4June2018 (PDF)**

# ONAP CM Casablanca Functional Requirements

ONAP Casablanca Developer Forum

June 21, 2018

# Change Management Functionalities

- **Flexible workflow design and orchestration**
- Catalog in SDC for meta-data Activities/building blocks
- Designer/editor in SDC for creating workflow
- TOSCA parser enhancements
- Service Model Distribution that includes workflow deployment in SO
- Execute workflow in SO (initiation via API)
- Rainy day handling for unsuccessful workflow steps (At Error Abort/Continue options)
- **Traffic migration building block**
- Common API definition for traffic migration (e.g., source, destination, traffic distribution weights)
- Demonstration across different VNF types – vGW/vCPE, vFW, vVOLTE
- Assessment on commonalities/differences across VNF types
- Incorporate recipe for traffic migration as part of in-place software upgrade workflow
- Develop recipe (using Ansible, NETCONF or REST) for traffic migration depending on the protocol
- **5G RAN PNF Software upgrade**
- Existing in-place software upgrade to demonstrate application to 5G RAN PNFs
- Health check (pre/post)
- Software download, installation and activation
- Roll-back for unsuccessful execution
- Manual processing / intervention for failures/roll-back issues
- **Basic change scheduler**
- Schedule a VNF instance at specific time to execute the change management workflow



**FILE: ONAP Casablanca Architecture Readout (PPTX)**

# ONAP Casablanca Architecture Draft for Community Review

## Chris Donley

ONAP Casablanca Developer Forum

June 21, 2018

# ONAP Casablanca Architecture (Draft)

(High-Level View with Projects)

Version 2.0.4  
6/20/2018

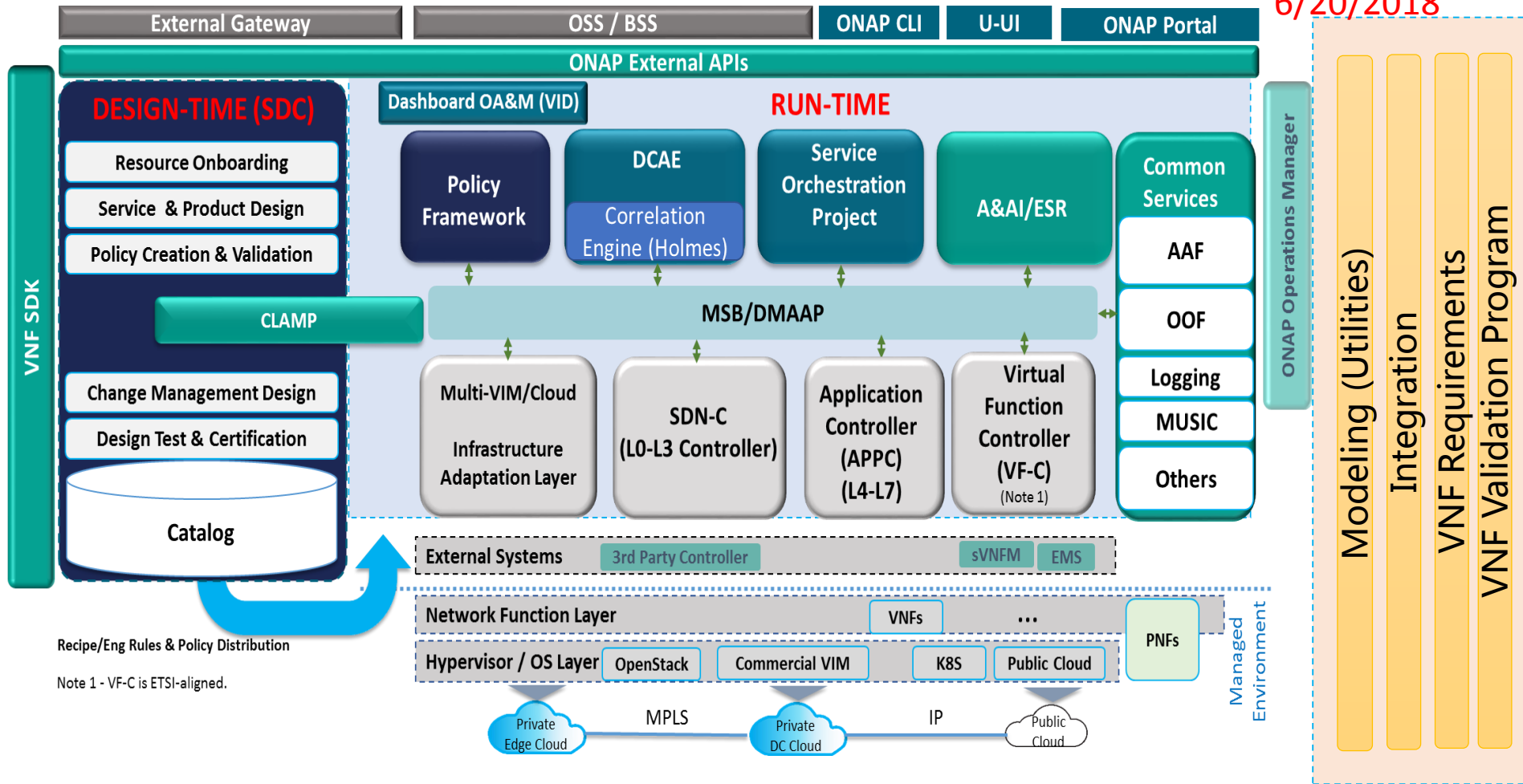





# ONAP COMMUNITY & PROCESS



**FILE: Annual Elections (PDF)**

# Community Elections (PTL & Sub-C)

## Kenny Paul

ONAP Casablanca Developer Forum

June 19, 2018

# Differences between PTL & SubC & TSC Elections

	TSC	TSC chair	Subcommittee chair	PTL	Committer
Defined	charter	4.1.2	4.4	Technical Doc 3.1.3	3.1.2
	required	required	optional	required	required
Membership criteria	TBD will become sec 4.1.1 of tech doc	As defined in 4.1.1 tech doc	Self determined Tech Doc 4.4.1.1	From pool of current Committers 3.2.3.1	Contributors to the project
Eligibility	TBD will become sec 4.1.1 of tech doc	Self nominated Tech doc 4.2.2.1 Any member of the TSC	Self nominated from membership 4.4.1.3	Self nominated From the pool of current Committers 3.2.3.1	Invited to join by existing Committers based upon merit.
Voting eligibility	TBD will become sec 4.1.1 of tech doc	4.1.2 All Members of the TSC	Members of record when the nominations are opened 4.4.1.4	Existing project Committers	Existing project Committers



**FILE: ONAP Casablanca Process Improvements v4 (PDF)**

# ONAP Casablanca Process Improvements

[@Catherine Lefevre](#), [@Gildas Lamilis](#),  
[@Seshu Kumar M](#), [@Eric Debeau](#), [@Alla Goldner](#),  
[@Helen Chen](#),  
[@Chris Donley](#), [@Stephen Terril](#), [@Kenny Paul](#),  
[@Jason Hunt](#), [@Brian Freeman](#), [@Tim O'Keefe](#)  
Alex Vul, [@ramki krishnan](#)

ONAP Casablanca Developer Forum

June 20, 2018

# Items Covered

## 1. CI-CD

- Self-commit

- Increase CI-Management committers list

## 2. Testing

- Improve time to get the full ONAP installed and started

## 3. Release milestones

- Enforcement: respect and act upon automated results (naming and shaming if criteria not met at Milestones)

## 4. Labs and Infrastructure

## 5. Code Coverage

## 6. Security and License

## 7. SLA



**FILE: latform Maturity S3P Discussion 20June 2018 (PDF)**

# Platform Maturity (S3P) Discussion Casablanca

## Jason Hunt

ONAP Casablanca Developer Forum

June 21, 2018

# Suggestion on new Usability

- **Level 1**

- User guide created
- Deployment documentation
- API documentation
- All new API's must adhere to the ONAP API Common Versioning Strategy and Documentation Guidelines;
- All existing APIs must be documented in Swagger 2.0
- Adherence to coding guidelines

- **Level 2**

- **API Documentation**
- All new API's, all external APIs, and all existing API's that are modified must adhere to the ONAP API Common Versioning Strategy and Documentation Guidelines
- Consistent UI across ONAP projects
- Usability testing conducted
- Tutorial documented

- **Level 3**

- **API Documentation**
- All API's for a given project must adhere to the ONAP API Common Versioning Strategy and Documentation Guidelines



**FILE: [What is Groups.io Quick Feature Guide \(PDF\)](#)**

# What is Groups.io

ONAP Casablanca Developer Forum

June 21, 2018



# What is Groups.io?

A mailing list service for community collaboration.

Each project has a main, announce-only group, with subgroups for each specialised discussion list.

Timesaving UI management features benefit owners, moderators, and list members.

- › Web UI offers features such as bulk changes, in-thread replying, and a single source for accessing all your projects and lists
- › Hashtags have robust features that allow for better participation and list management
- › Customizable member notices
- › Integrations are available, including Github and Trello
- › UI-based Polls, Calendar, and simple Wiki functions
- › Read-only setting for lists that are closed instead of current soft-lock settings



# INTEGRATION TESTING VALIDATION



**FILE: Integration Benchmark 2018-06-21.2 (PDF)**

# Integration / Benchmark

Helen Chen, Yi Yang

ONAP Casablanca Developer Forum

June 21, 2018

# ONAP Beijing Maturity Testing Area

Area	Priority	HEAT	OOM	Notes
Security	High	N/A	N/A	Handled by security subcommittee
Performance	Low/Med	Will test after release	Will test after release	
Stability	Med	Passed 72 hours	Passed 72 hours	HEAT based deployment is slightly more stable than OOM based at this moment: suggest to more tuning at Casablanca
Resiliency	High	N/A	100%	<ul style="list-style-type: none"><li>• Detection is less than 1 second;</li><li>• Recovering takes &lt; 15 minutes depends on network speed.</li><li>• Deleted aai-modelloader or dev-aai-resources-??. Closed loop failed immediately. Pod restarted in &lt; 5 minutes. <b>Closed loop never recovered. (Needs to change OOM config for it)</b></li><li>• (helm upgrade messed up the whole system, which will turn the system into un-useable status. However, we think this may not be a normal use case for production env.</li></ul>
Scalability	Low	Will test after release	Will test after release	
Manageability	High	N/A	N/A	Logs, etc.
Usability	Med	N/A	N/A	document



**FILE: Integration Lab 2018-06-21 (PDF)**

# Integration Lab - How to leverage Integration Lab and Related Tools for CI?

Helen Chen, Stephen Gooch, Scott Blandford, Sylvain Desbureaux, Gary Wu

ONAP Casablanca Developer Forum

June 21, 2018

# Our CI Journey

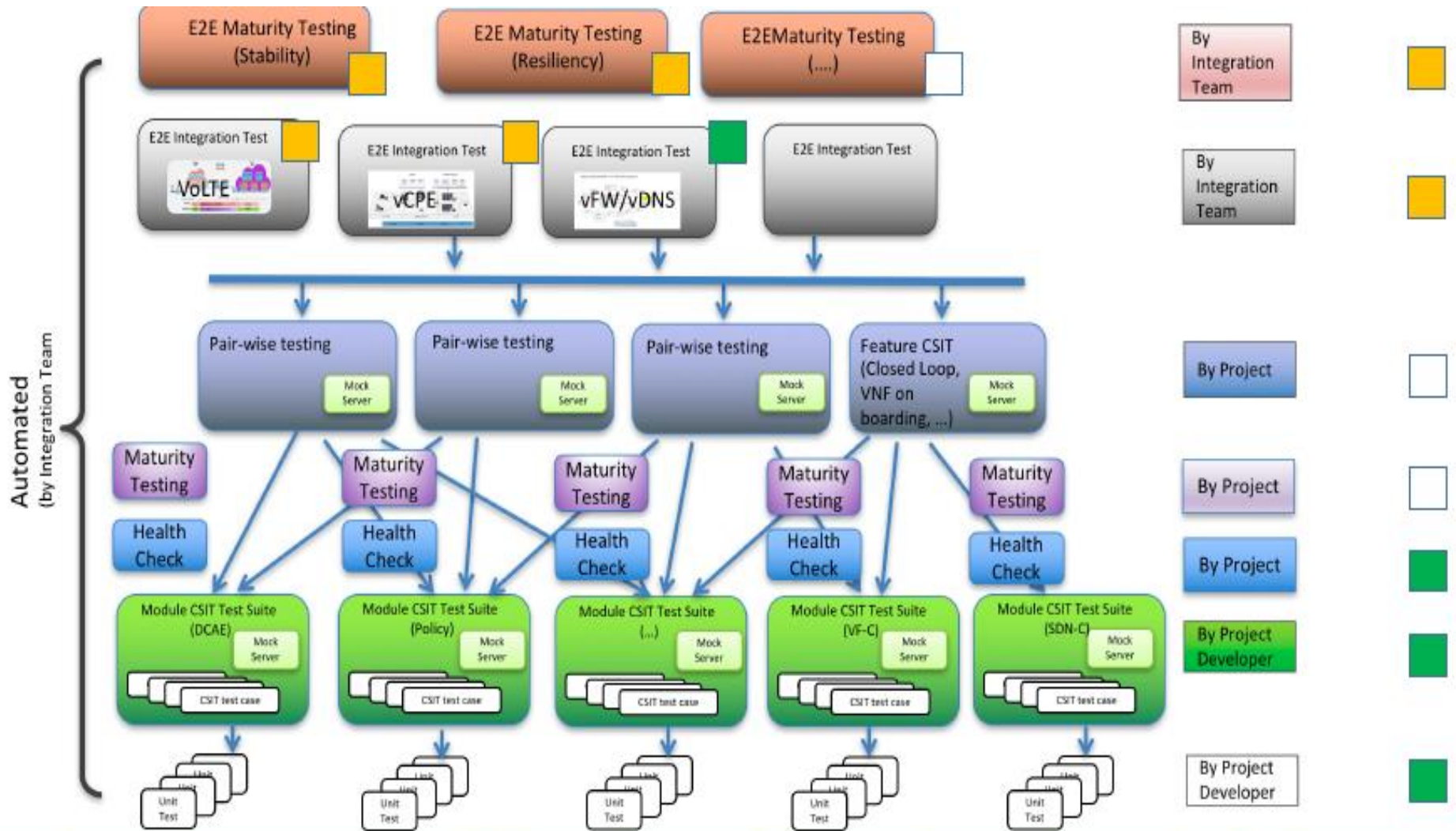

Our goal is to automate all the testing to achieve continuous integration / release



**FILE: VNF Compliance Verification-1 (PPTX)**

# VNF Compliance Verification proposal

Chris Donley & Steven Wright

ONAP Casablanca Developer Forum

June 21, 2018

# CVC Structure

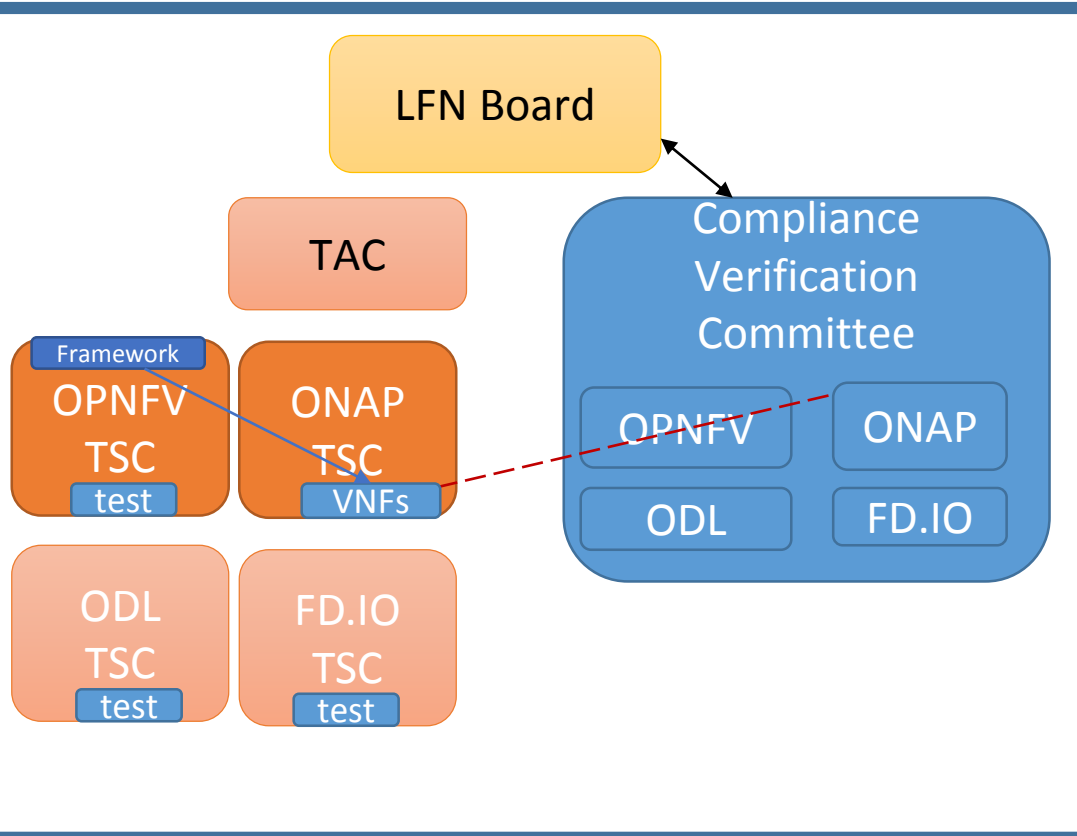

## Notes:

- Board delegated compliance/verification responsibility to CVC
- Test content is the responsibility of the TSCs
- Test framework will continue to be hosted in OPNFV (Dovetail), and will support x-project requirements
- CVC will work with the testing groups in each community to ensure alignment and transparency
- TSCs are involved by developing and approving test content





# SERVICE PROVIDER PRESENTATIONS



**FILE: Orange ONAP Introduction Strategy (PDF)**

# Orange ONAP introduction strategy

Vincent Colas

ONAP Casablanca Developer Forum

June 21, 2018

# Mapping Future OSS and ONAP Beijing Architecture

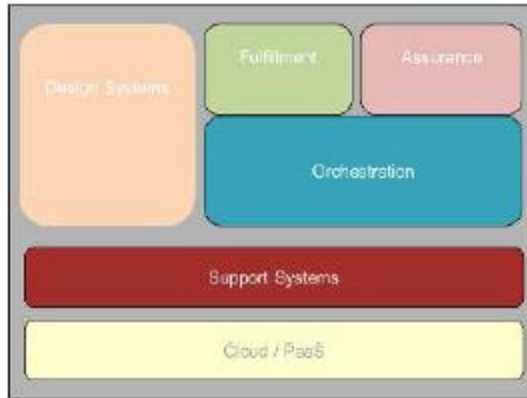

Future OSS Functional Domains

## ONAP – Based on Beijing Architecture

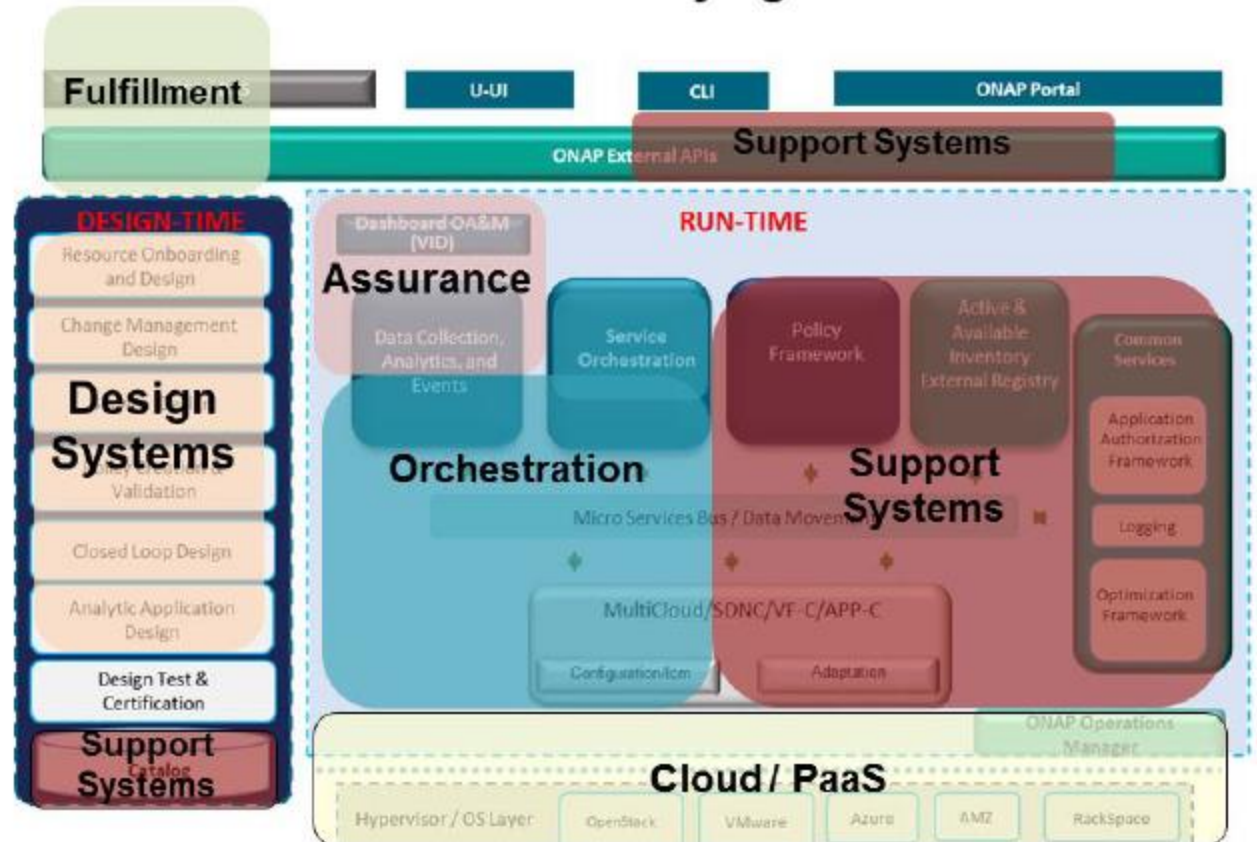

# Strategic Approach for ONAP Adoption in the Orange Group

## Our Positioning about ONAP

- ONAP is a platform offering a comprehensive toolkit to automate fulfillment and assurance processes in the Network Management domain.
- Starting in 2018, every new project or enhancement in Orange concerning VNF Management, OSS Transformation and Automation should be based on ONAP

## Our Expectations on ONAP

- ONAP is chosen by Orange Group as the automation layer for:
  - The entire MANO domain, with the exception of VIM functions (VNF/NS Life Cycle Management)
  - Service Orchestration both for virtualized and physical functions

## Our Approach for ONAP Implementation

1. Understand how ONAP functionalities can be used
2. Introduce ONAP through concrete use cases



**FILE: ONAP Deployability Requirements from Service Provider (PPTX)**

# Deployability requirements from a service provider perspective

Eric Debeau, Sylvain Desbureaux

ONAP Casablanca Developer Forum

June 21, 2018

# Deployability Requirements

- ONGOING POCS
- OPEN LAB
- ORANGE OPEN LAB (Facts and Figures)
- TOOLS TO CONFIGURE ONAP PLATFORM
- TOOLS TO OPERATE ONAP PLATFORM
- TOOLS TO MONITOR ONAP
- TOOLS TO AUDIT DEPLOYMENTS
- STORAGE STABILITY
- DEPLOYMENT IN OPERATIONAL IT
- CASABLANCA PROPOSALS



# ONAP PROJECTS (DCAE, VID, SDNC etc)



**FILE: ONAP Beijing DCAE Operational Perspective \_v\_final (PDF)**

# ONAP Beijing DCAE operational perspective (DCAE PROJECT)

## Pawel Pawlak

ONAP Casablanca Developer Forum

June 21, 2018



# DCAE R2 Architecture

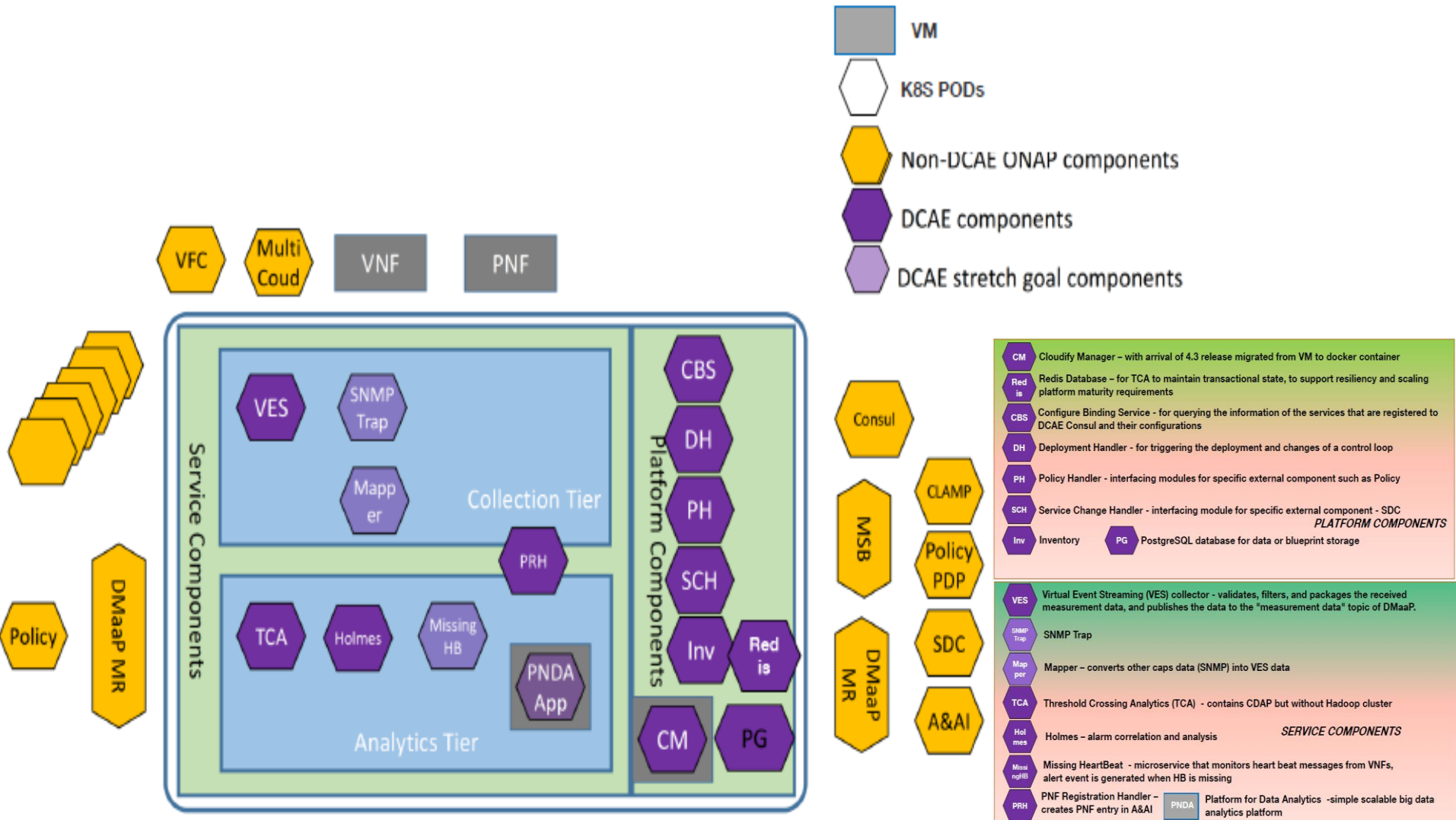

# Summary

- DCAE component plays an important role in overall ONAP platform acting as central point for Data Collection, Analytics, and Events generation in ONAP.
- The evolution of DCAE in Beijing release gives perspective for this platform to be mature enough in R3 which is to simplify the deployment (FLINK – as part of use case does not work very well with DMaaP, Prometheus, Data File Collector, 3GPP PM Mapper support and further enhancements) or R4 for operational deployment.
- Additional effort should be taken in DCAE solution operational troubleshooting – creating guidelines would be helpful.
- DCAE integration with an existing OSS environment (OCEANE, GNOC tools) in Orange
- Knowledge transfer and trainings must be considered for operational teams to understand DCAE architecture, TOSCA model, Kubernetes, Openstack, HEAT template and HELM chart.
- Availability of Sandbox, OpenLab for Ops is crucial to enhance discovery capabilities and knowledge transfer efficiency.



**FILE: DCAE-DS Casablanca (PPTX)**



**SDC**

Service Design and Creation

Revolutionizing the Network

# DCAE-DS

Data collection analytics and events  
Design Studio  
(DCAE PROJECT)

ONAP Casablanca Developer Forum

June 19, 2018

# SDC pluggable architecture, DCAE-DS

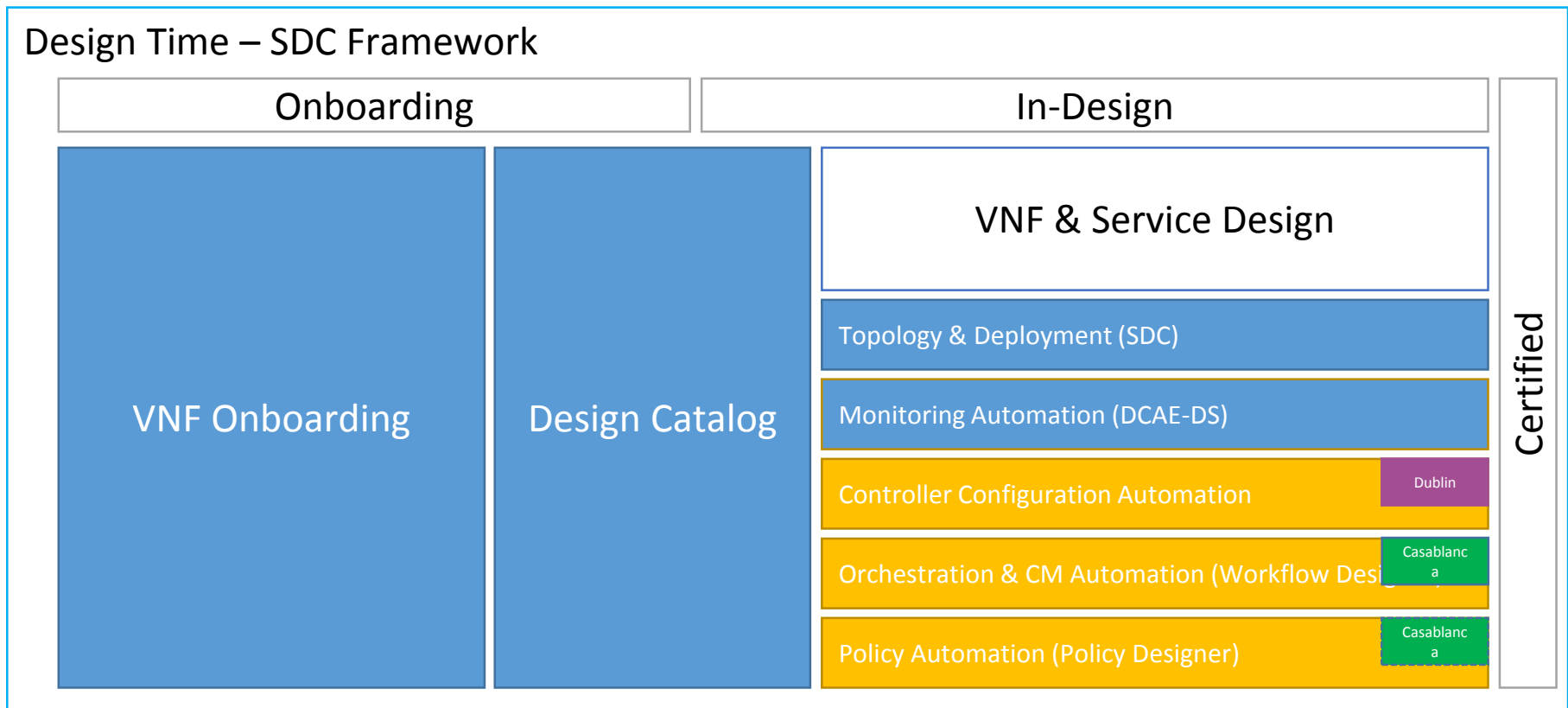

- The TOSCA models Representing mS are onboarded to SDC and form the building blocks for the monitoring templates.
- Design-time configuration of the monitoring building blocks is based on the onboarded TOSCA models, allowing users to set available and required parameters regardless of deployment details.
- The monitoring templates (composition, configuration, attributes) are represented by Cloudify Blueprints and are distributed as part of the SDC service certification process.



**FILE: SDC R3 Enhancement roposals V2 (PPTX)**

# SDC R3 Enhancement Proposal (SDC PROJECT)

Kang Xi  
kang.xi@huawei.com

ONAP Casablanca Developer Forum

June 21, 2018

# SDC R3 Improvements

- **Import csar packages and re-edit to generate new services**
- **Combination of multiple components**
- **GUI enhancement**
- **Flexible service/resource version control**
- **Value to integrate more design-time tools into SDC**

# What is the ultimate goal of SDC and how to get there?

## SDC

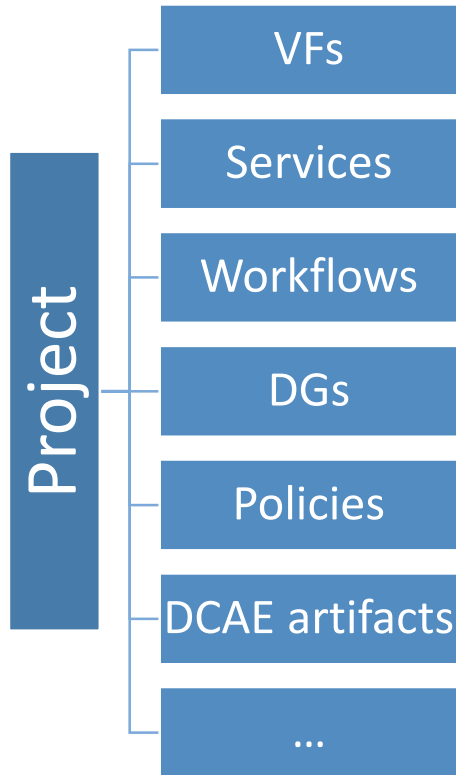

Some artifacts are embedded in the service template, some are distributed individually, some common artifacts do not need to be distributed, only references are needed.



## Run Time

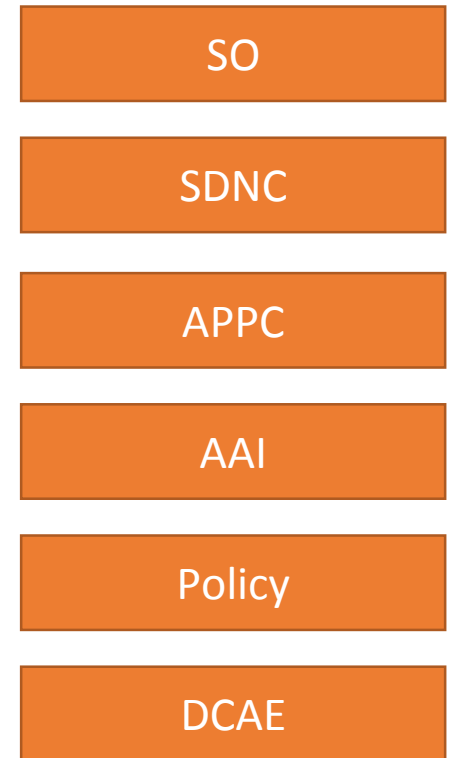



**FILE: Mcloud R3 Update (PPTX)**

# Multi-VIM/Cloud – Progress and Proposals for R3 (MULTI-VIM PROJECT)

VMware: Xinhui Li, Liang Ke, Ethan Lynn, Bin Sun

Wind River: Bin Yang, Gil Hellmann

Intel: Addepalli, Srinivasa

Amdocs: Chapnick, Avi

Arm: Tina Tsou

ATT: Brian Freeman, Catherine Lefevre, HILTUNEN, MATTI

CMCC: Lingli Deng, Yan Yang, Lin Meng

ONAP Casablanca Developer Forum

June 21, 2018



# Multi VIM Cloud

- **Azure Plugin**
  - Allow ONAP seamlessly orchestrate VNFs across different cloud providers and regions , private and public.
- **HPA Enhancement**
  - HPA discovery by ONAP MultiCloud Plugins
- **K8s Plugin for Cloud Regions**
  - ONAP to place containerized VNFs and normal VNFs in K8S based cloud-regions and edge-clouds
- **Integration with OPNFV Auto**
  - Auto validates business value of ONAP, especially within an OPNFV infrastructure: integration of ONAP and OPNFV.
  - Business value is measured in by service quality (performance, reliability, ...) & OPEX reduction (VNF management simplification, power consumption reduction, ...).



**FILE: VID ONAP Demo (PPTX)**



VID

Virtual Infrastructure  
Deployment

# VID Demo (VID PROJECT)

## Michael Lando

ONAP Casablanca Developer Forum

June 21, 2018

# Casablanca Contribution

- Support Bulk Macro Instantiation.
- Break the Assignment Process to Phases.
- Association of VNFs to an already-instantiated Networks.
- Network Service Instantiation.
- Change-Management Operation will include the ability to Schedule an Operation.
- We are evaluating approved use-cases that might include more platform enhancements.

PNF plug & play.

Change Management enhancements:

Integration with workflow designer, canceling a workflow execution.

Scale out – enhancements to Beijing’s scaling out.

VoLTE – continue supporting and enhancing Volte support in VID.



**FILE: ONAP SDNC Geo-Redundancy Lessons (PPTX)**

# Resiliency and Geo-Redundancy – Lessons from SDNC (SDNC PROJECT)

## Sharon Chisholm

ONAP Casablanca Developer Forum

June 20, 2018

# SDNC Resiliency

Product	Site Resiliency	Component Auto Restart	Geo-Redundancy	Manual Switch	Auto-switch	Site Reversion
<b>ONAP Amsterdam</b>	Multiple ODL in cluster	No	No	No	No	No
<b>ONAP Beijing</b>	Yes	Yes	Yes	Yes (2 step)	No	Manual (2 Step)
<b>ONAP Casablanca</b>	Yes	Yes	Yes	Yes (1 step)	Yes	Manual (1 step)

# SDNC Resiliency Architecture

pod

deploy kind

service

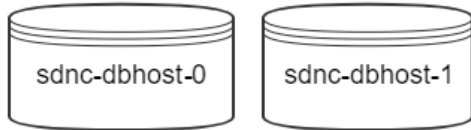

StatefulSet

dbhost (headless)	
dbhost-read	
sdnctldb01 (headless)	
sdnctldb02 (headless)	

- 2 DB pods
- 3 sdnc (ODL) pods
- 1 admin (portal) pod
- 1 dgbuilder pod

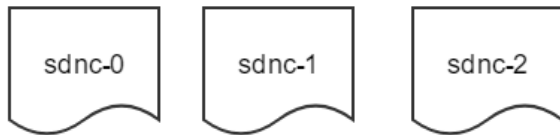

StatefulSet

sdnhost (NodePort)	
sdnhost-cluster (Headless)	



Deployment

sdnc-dgbuilder (NodePort)	
------------------------------	--



Deployment

sdnc-portal (NodePort)	
---------------------------	--

Less critical functions don't need local replication if they can restart quickly



**FILE: OOM Helm Charts Ownership Beijing (PDF)**

# OOM Helm Charts Ownership (OOM PROJECT)

## Borislav Glozman (Amdocs)

ONAP Casablanca Developer Forum

June 21, 2018

# Helm Chart Ownership

The project teams will take formal ownership of the helm projects in the Casablanca release charts for their

- OOM team will be primarily focused on deployment hardening, maintainability, and new features
- Project teams know best how to update the charts to address gaps for:

Changes to configuration files, Application scaling, Managing node ports, Software Upgrade and Roll-back support, DB migration scripts (both forward and backward), Resource requirements for each container, Anti-affinity rules

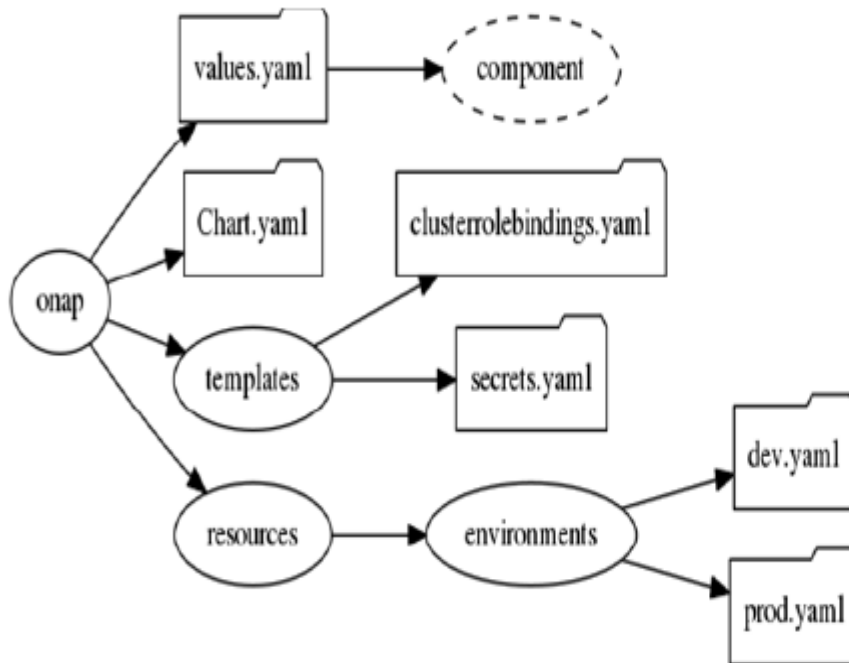

```
oom/kubernetes/onap/  
├── charts  
├── Chart.yaml  
├── requirements.yaml  
├── resources  
│   ├── environments  
│   │   ├── dev.yaml  
│   │   └── disable-allcharts.yaml  
├── templates  
│   ├── clusterrolebinding.yaml  
│   └── secrets.yaml  
└── values.yaml
```





**FILE: MSB Plan to Support Micro Services Based Architecture with Istio Service Mesh (PDF)**

# MSB's Plan to Support Microservice- Based ONAP with Istio Service Mesh (MicroServices Bus = MSB PROJECT)

## Huabing Zhao, PTL of MSB Project

ONAP Casablanca Developer Forum

June 21, 2018

# Micro-Service Bus Overview Components

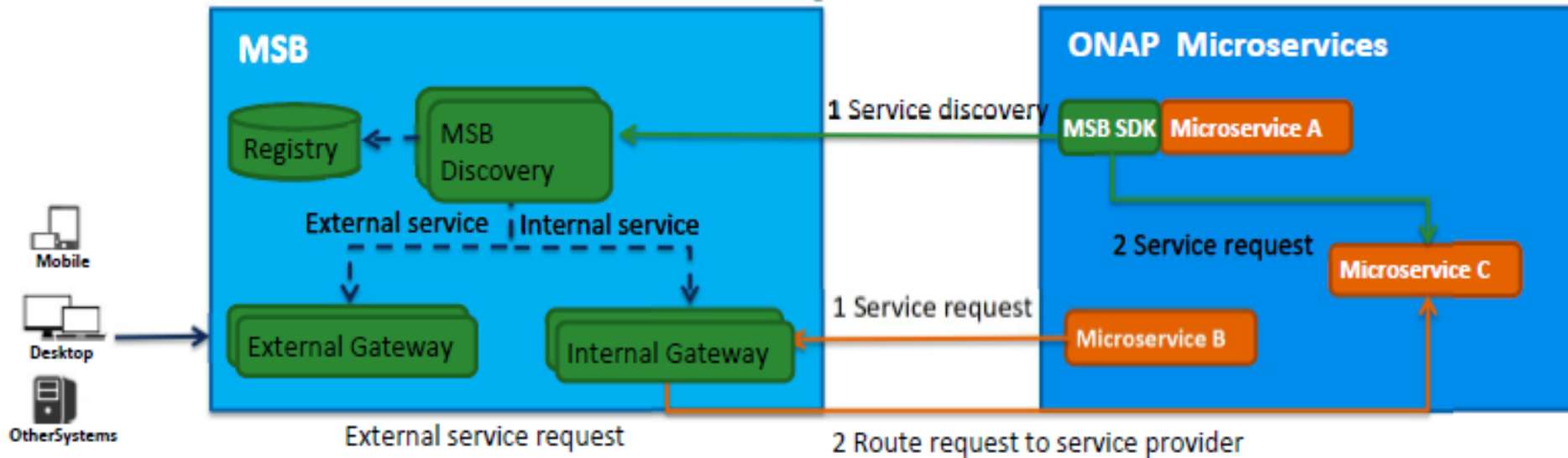

- Registry  
Service information storage, MSB uses Consul as the service registry.
- MSB Discovery  
Provides REST APIs for service registration and discovery
- API Gateway  
Provide service request routing, load balancing and service governance. It can be deployed as external Gateway or Internal Gateway.
- MSB SDK  
Java SDK for point to point communication



**FILE: 2018-06 ONAP Security sub-committee Presentation-pa3 (PPTX)**

# ONAP Security sub-committee Presentation

## - Casablanca Focus -

2018-06

# “What’s done”, “What’s on” and “What’s coming”

## What’s Done

Casablanca  
S3P for  
security

Vulnerability  
Management  
Procedure

Certificate and  
authentication  
support via  
AAF

VNF package  
security  
recommendat  
ion using  
SOL005 (VNF  
package)

## What’s Happening

Secure  
communication to  
xNF aka 5G use  
case security

“pluggable”  
authorization

Secure  
communication  
between ONAP  
components  
with/without  
ISTIO

Recommended  
protocols

Secure  
communication  
with/without ISTIO

Static code scanning

ONAP attack vector  
analysis  
(aka threat  
analysis)

## What’s Coming

Security  
Review of xNF  
requirements

Next level of  
VNF package  
security

Secure  
infrastructure  
scanning  
(Norad)

....



**FILE: VF-C You Don't Know v1.1 (PPTX)**

# The VF-C You Don't Know (VF-C PROJECT)

Yan Yang  
VF-C PTL

ONAP Casablanca Developer Forum

June 21, 2018

# VF-C Architecture

VF-C mapping to ETSI NFV-MANO Architecture

VF-C provides an ETSI NFV compliant NFV-O function, generic VNFM , NS/VNF Catalog, NFV Instances DB

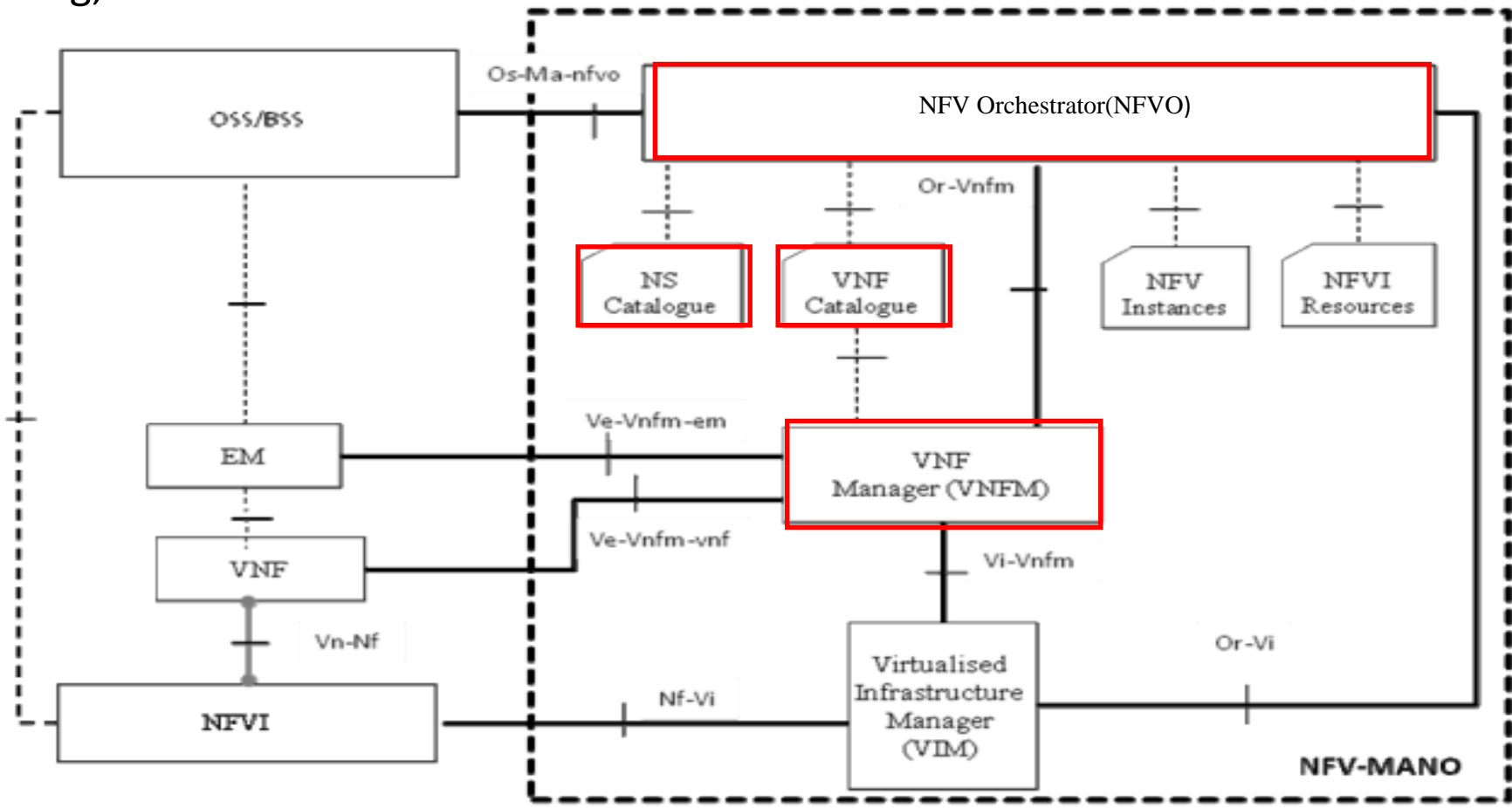



# ONAP DEPLOYMENT



**FILE: Discussion on the requirement for acceleration management of ONAP (PPTX)**

# Discussion on the requirement for acceleration management of ONAP

Lei Huang

ONAP Casablanca Developer Forum

June 19, 2018



# Accelerator Usage Model

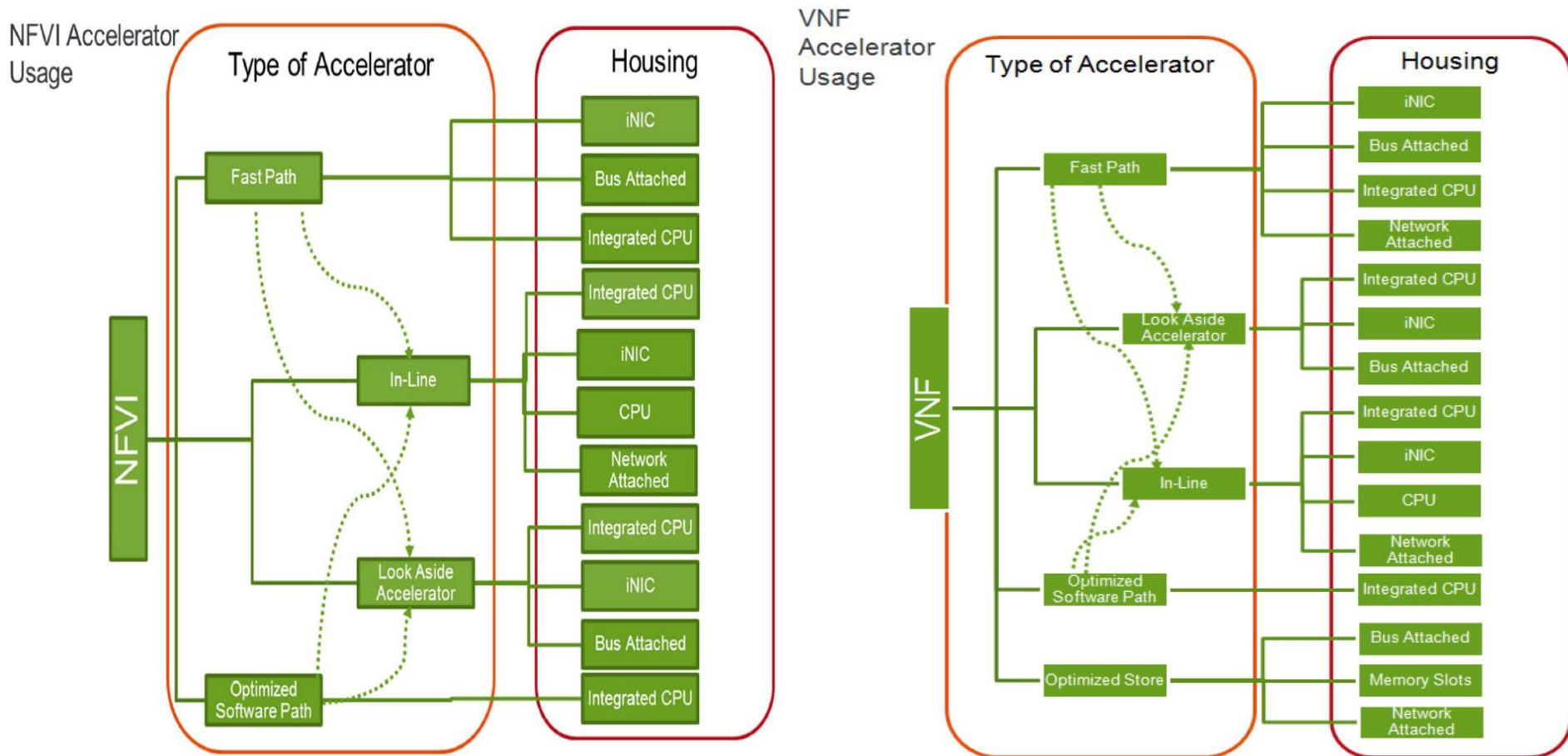

In order to accommodate the possibility of a disaggregated deployment, we use acceleration management to ensure higher-level orchestration capabilities, utilization monitoring, and customer SLAs are supported.



**FILE: Edge Automation Potential Strategies for Deploying ONAPv0.8 (PPTX)**

# Edge Automation – Potential Strategies for Deploying ONAP at Edge

Evgeniy Zhukov, Netcracker  
Manoj K Nair , Netcracker

ONAP Casablanca Developer Forum

June 19, 2018

# uCPE Edge Site Use Case

End-to-End Solution to automate LCM of PNFs, AFs, VNFs on the customer edges

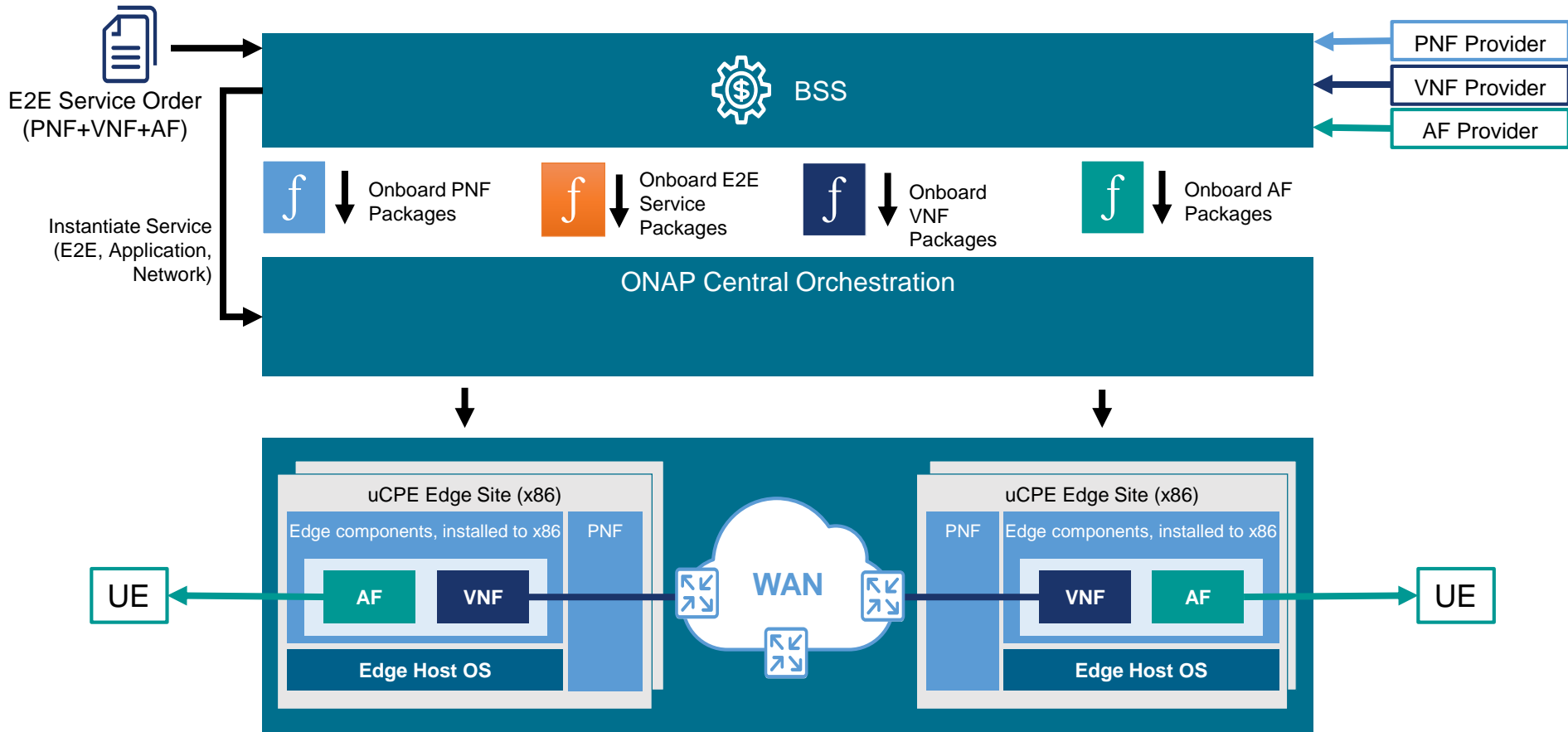

# Typical Management Functionalities at Edge for various NFV based Use Cases (General) – Reference ETSI MEC

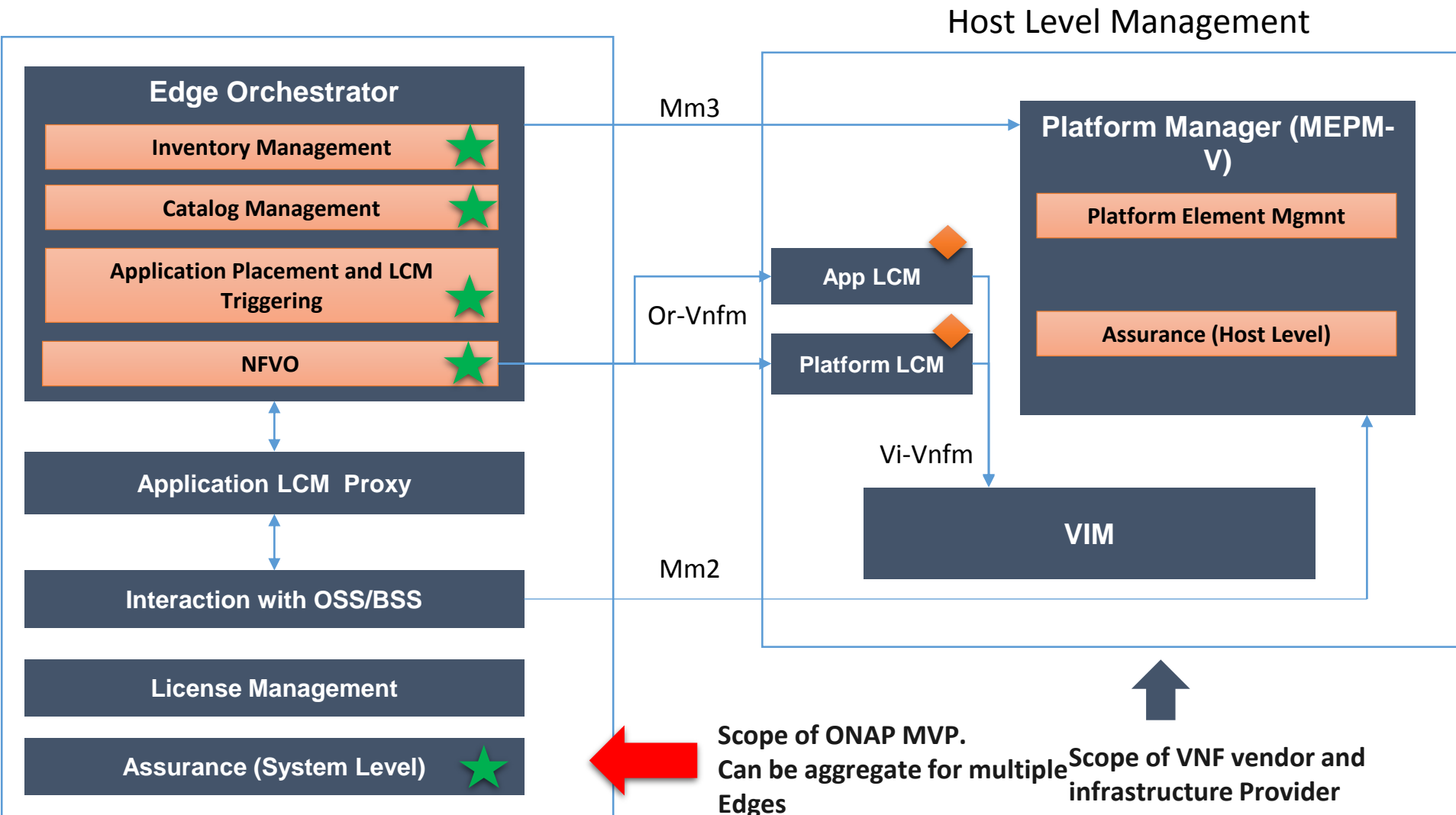

★ Available Functions in ONAP, but need adaptation for MEC.

◆ Optionally placed at System Level as well



**FILE: Consistent Representation and Identification of Cloud Region (PDF)**

# ONAP Casablanca Requirement: Consistent representation and identification of a cloud region in ONAP

Bin Yang (Wind River) May 17, 2018

ONAP Casablanca Developer Forum

June 19, 2018

# Multiple representation for a Cloud Region

## Single/Centralized representation of a cloud region

- All ONAP modules leverage cloud region representation in AAI
- Depreciate all other representations in other ONAP modules, e.g. cloud-sites in SO, vm\_properties in Robot

## Consistent Identification of a cloud region

- Use composed keys: {cloud-owner} + {cloud-region-id} to identify a cloud region
- Depreciate the usage of the {cloud-region-id} only
- Depreciate the usage of {vim-id}
- dcaeLocation is equivalent to a tenant under a cloud region, suggest dcaeLocation can be mapped to a cloud region + tenant

## Impacted projects

- Multiple ONAP projects are involved
  - VID, SO, SDNC, OOF, VFC, MultiCloud, UII, DCAE, DMaaP, Integration
- Some consumers of MultiCloud need to be scrutinized
  - APPC, etc.
- They are using the “vim-id” but in an transparent way: fetch it from AAI and pass it to MultiCloud

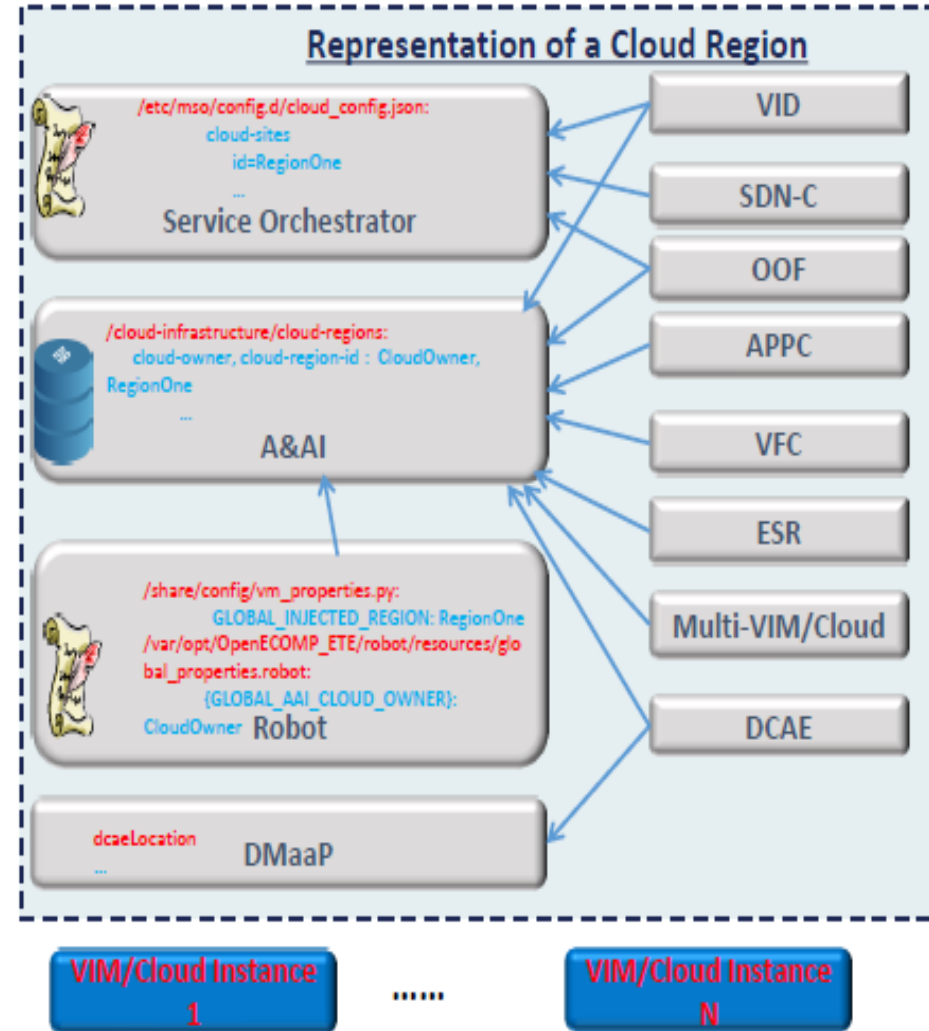



**FILE: MultiCloud Deep Dive**

# ONAP MultiCloud Deep Dive

ONAP Casablanca Developer Forum

June 21, 2018

# HPA Discovery & Registry, VIM Capacity Check

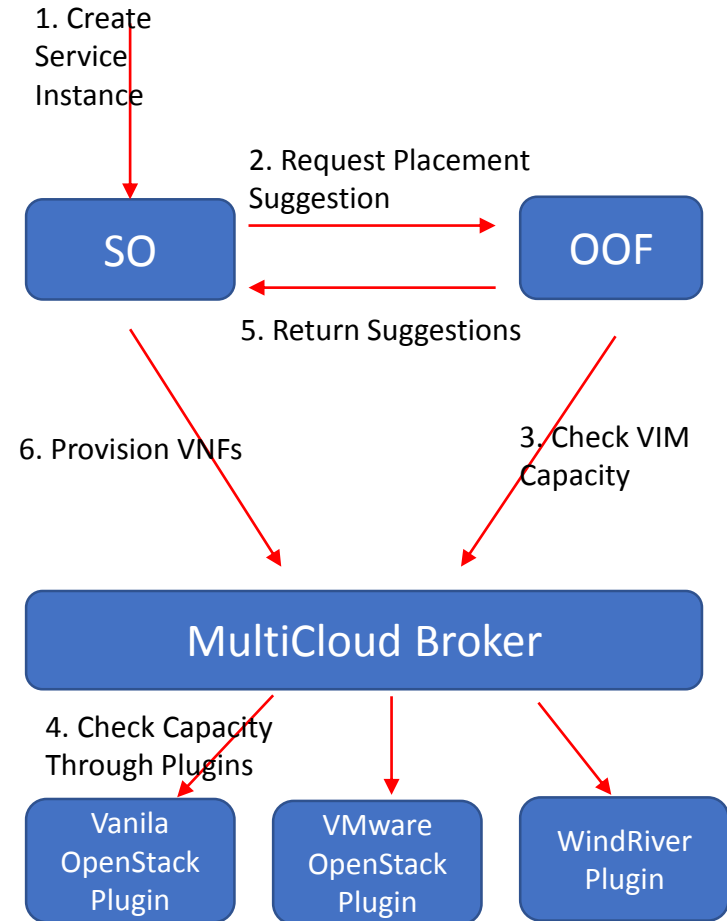
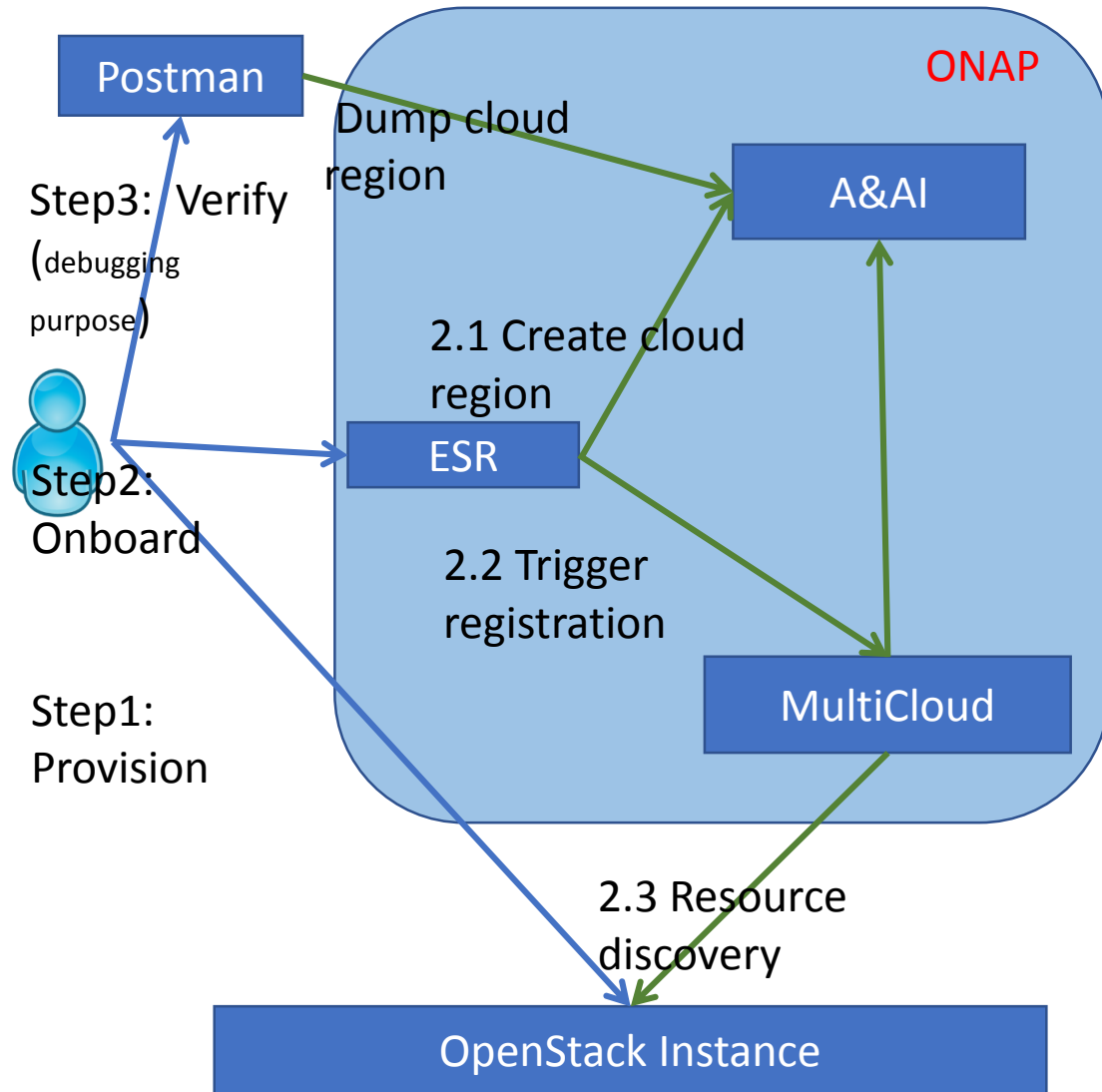





**FILE: ONAP ExtAPI\_Enhancement Proposal Summary v1 (PPTX)**

# ONAP Casablanca External API Framework Enhancements Proposal

Adrian O'Sullivan Huawei [Adrian.Osullivan@Huawei.com](mailto:Adrian.Osullivan@Huawei.com)  
Ludovic Robert Orange [Ludovic.robert@orange.com](mailto:Ludovic.robert@orange.com)

ONAP Casablanca Developer Forum

June 21, 2018

# Categorizing ONAP External Open APIs

- *Service Catalog APIs*
- *Service Qualification / Service Feasibility APIs*
- *Service Ordering & Activation APIs*
- *Service Inventory / Topology / Operational State APIs*
- *License Management APIs*
- *Billing Management / Service Consumption / Usage APIs*

- *Security Management / Privacy Management APIs*
- *Service Quality Management / Service Level Agreement APIs*
- *Service Test Management/Service Monitoring APIs*
- *Resource Reservation / Address Allocation Management APIs*
- *Service Trouble Ticketing APIs*
- *Change Management APIs*
- *Service Policy Management APIs*

## Northbound Open APIs



## East/West APIs

- *Service Instantiation/Configuration/Activation Inter Domain APIs*
- *Service Policy Management/Distribution APIs*
- *Service Event Sharing APIs*
- *Service State Sharing APIs*
- *Service Performance Sharing APIs*
- *Service Fault Sharing APIs*
- *Inter-Domain e-2-e Service Test APIs*
- *License Management Inter Domain APIs*
- *Inter Domain Resource Reservation APIs*
- *Inter Domain Service Consumption/Usage APIs*
- *Inter Domain Service Trouble Ticketing APIs*

## Southbound Open APIs

- *Legacy OSS/EMS Adapter APIs*
- *External Controller APIs*
- *Data Collection APIs ( Performance, Fault , Usage)*
- *External Inventory / Topology Discovery APIs*

- *Multi-VIM Southbound APIs / SVNFM Adapter APIs*
- *Policy Management/Distribution APIs*
- *Network Adapter APIs ( RESTCONF / NETCONF / BGP-LS / PCEP ... )*
- *Configuration Adapter APIs ( Chef , Ansible, Puppet ... )*

# ONAP Northbound APIs Casablanca Enhancement Summary

Category	Description	Delivery Status	Casablanca Enhancements
<b><i>Service Catalog APIs</i></b>	Allows the Service Specification Capabilities of the ONAP Services to be discovered for inclusion in Product Offerings in the BSS	Delivered in ONAP Beijing Release	Enhance to include a new TOSCA REST Toolset in SDC, to allow exposing the SDC Service apiSchema to the Service Catalog API. Addition of Notifications for Catalog changes.
<b><i>Service Ordering &amp; Activation APIs</i></b>	To allow northbound clients to order, activate and modify the ONAP Services that are exposed from the ONAP Service Catalog	Delivered in ONAP Beijing Release	Effort to connect SO APIs for full E2E service creation/activation and add service modification support. Also require the ability to track Service Order Items related Service State via notifications
<b><i>Service Inventory / Topology APIs</i></b>	To provide access to the clients of their Service Inventory views within their domains	Delivered in ONAP Beijing Release	Development needed to support better Service State management via notifications and more comprehensive Topology traversal capability in the APIs. Add support for depth and expand directives from TMF API Design guideline 3.0 on Service Inventory API.



**FILE: Physical Network Onboarding Proposal 0.3 (PPTX)**

# Proposal for Physical network onboarding in ONAP

Jianguo Zeng

ONAP Casablanca Developer Forum

June 21, 2018

# Physical network on-boarding to ONAP high level workflow

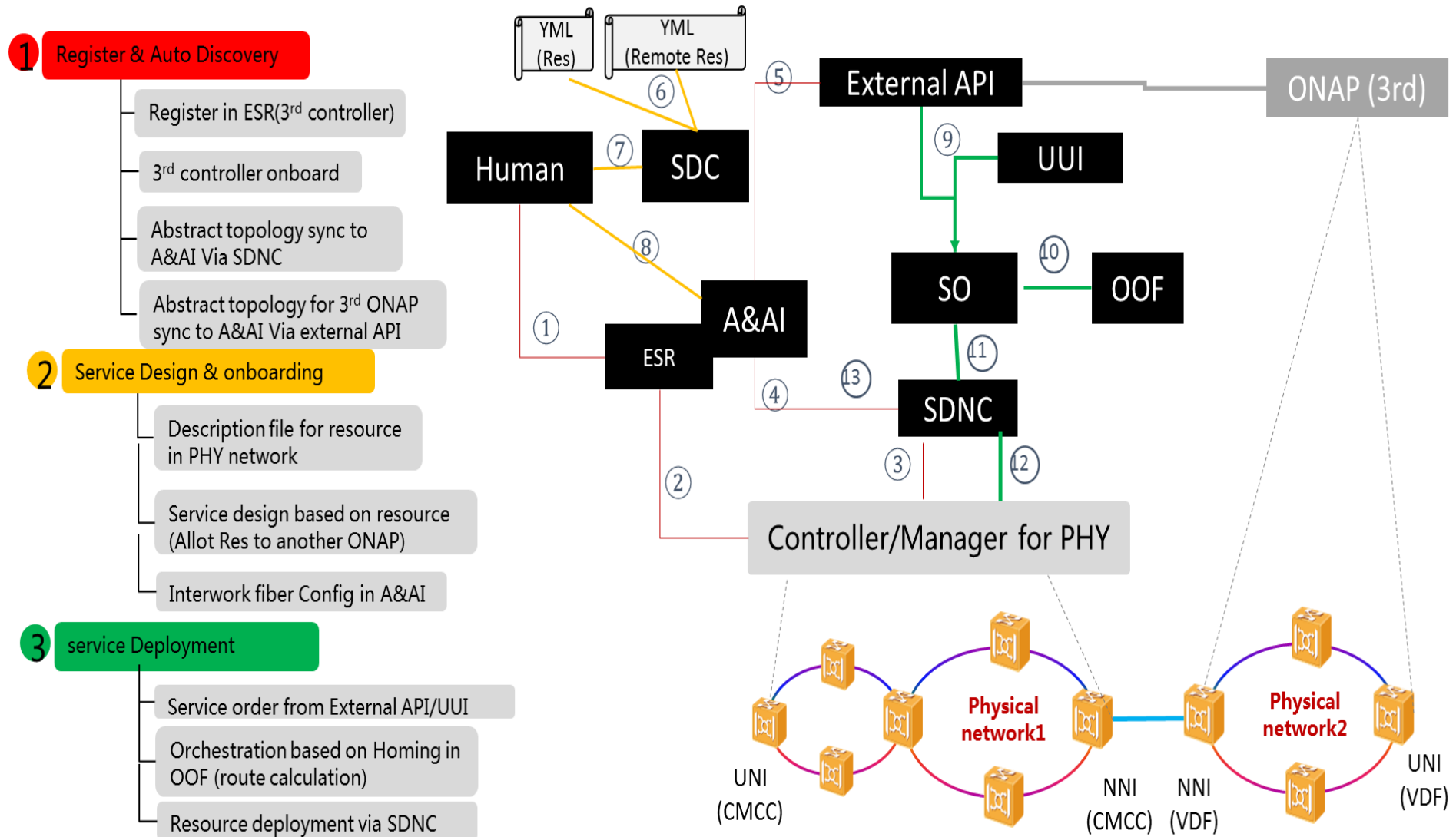



# SOFTWARE DEVELOPMENT



**FILE: TOSCA on Kubernetes (PDF)**



# TOSCA on Kubernetes

Introducing: Puccini

Tal Liron  
Principal Software Engineer  
NFV Partner Engineering

ONAP Casablanca Developer Forum

June 21, 2018

## 1. **TOSCA-to-Clout compiler**

“Clout” is the missing intermediary format

## 2. **Kubernetes profile for TOSCA**

Low-level plumbing packaged for high-level modeling

## 3. **JavaScript inside the Clout**

Domain-specific translations + validation/functions





**FILE: Containerized VNFs in ONAP**



**redhat.**

# Containerized VNFs in ONAP

**Cloud-Native Lifecycle Management in Kubernetes**

**Tal Liron**  
**Principal Software Engineer**  
**NFV Partner Engineering**

ONAP Casablanca Developer Forum

June 19, 2018

# Containers != Containers

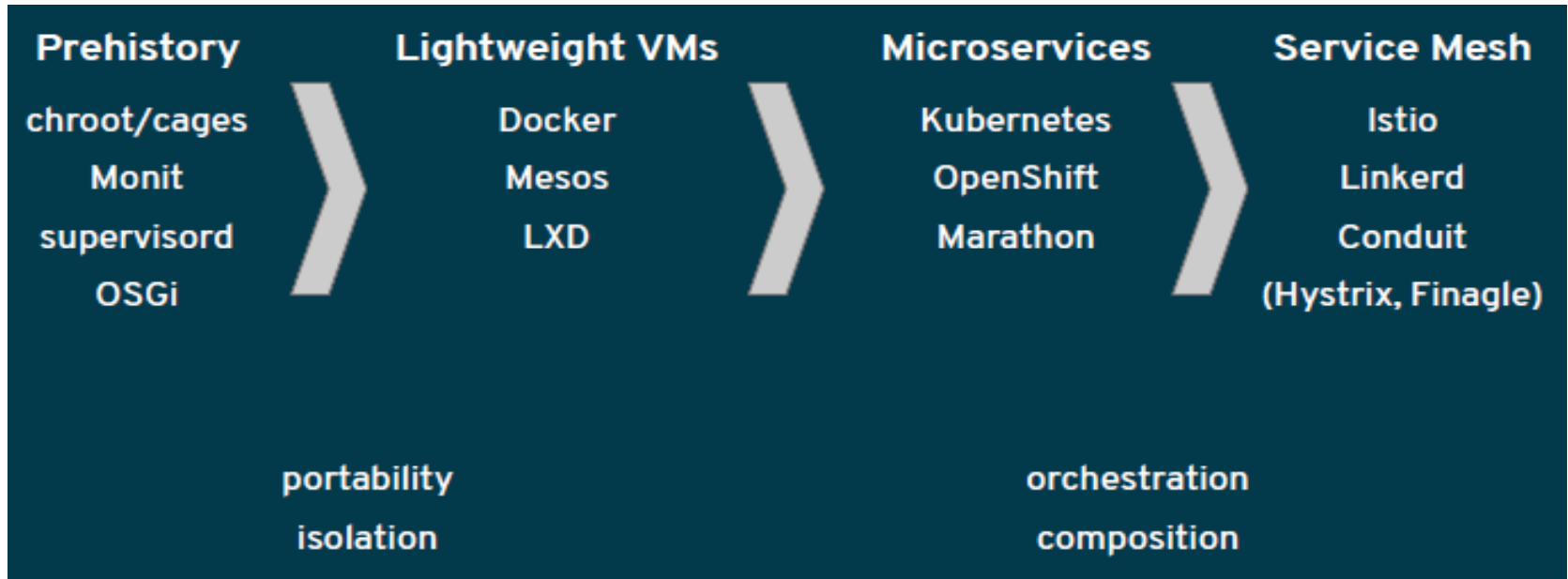

## 1. Cluster != Replicas

You can easily create 10 instances of a pod, but that doesn't mean they will magically work together

## 2. Control plane != data plane

Every pod has a single IP interface Sometimes that's fine ("piggybacking" on the control plane)

### 1. Dynamic Kubernetes

The running application itself will modify its Kubernetes resources (Deployment, Service, etc.)

### 2. Triggered by Events

Some can be internal: e.g. high load, must scale

Some can be external: e.g. policy has changed



**FILE: ONAP OOM K8S Deployment Beijing (PPTX)**

# ONAP/K8S Deployment

Borislav Glozman (OOM Team)

ONAP Casablanca Developer Forum

June 21, 2018

# Deploy ONAP on Rancher Kubernetes

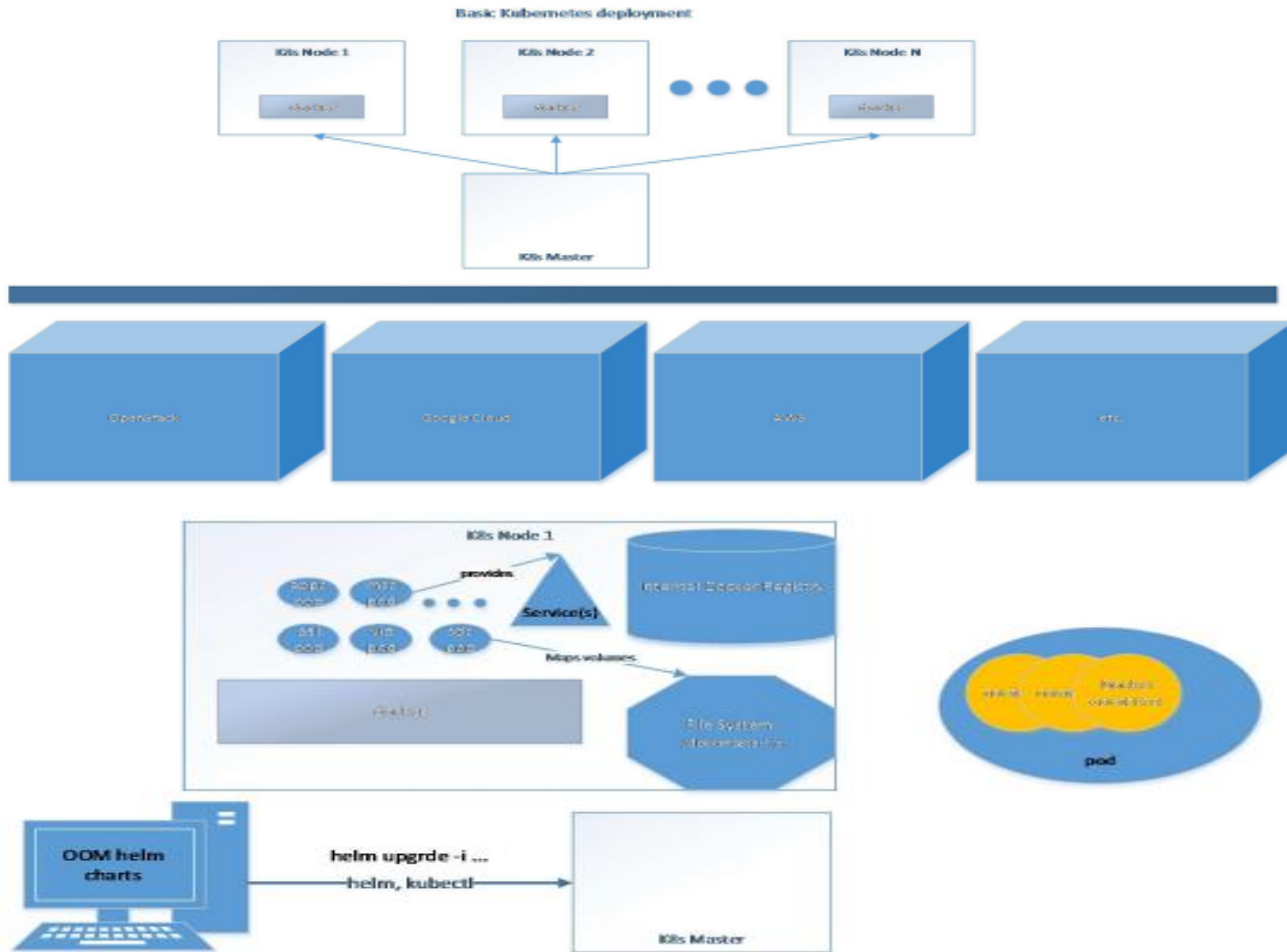



**FILE: ONAP VNF Developer Experience (PDF)**

# ONAP “VNF Developer” Experience

Eric Multanen - Intel

ONAP Casablanca Developer Forum

June 21, 2018

# End to End Demonstration Setup

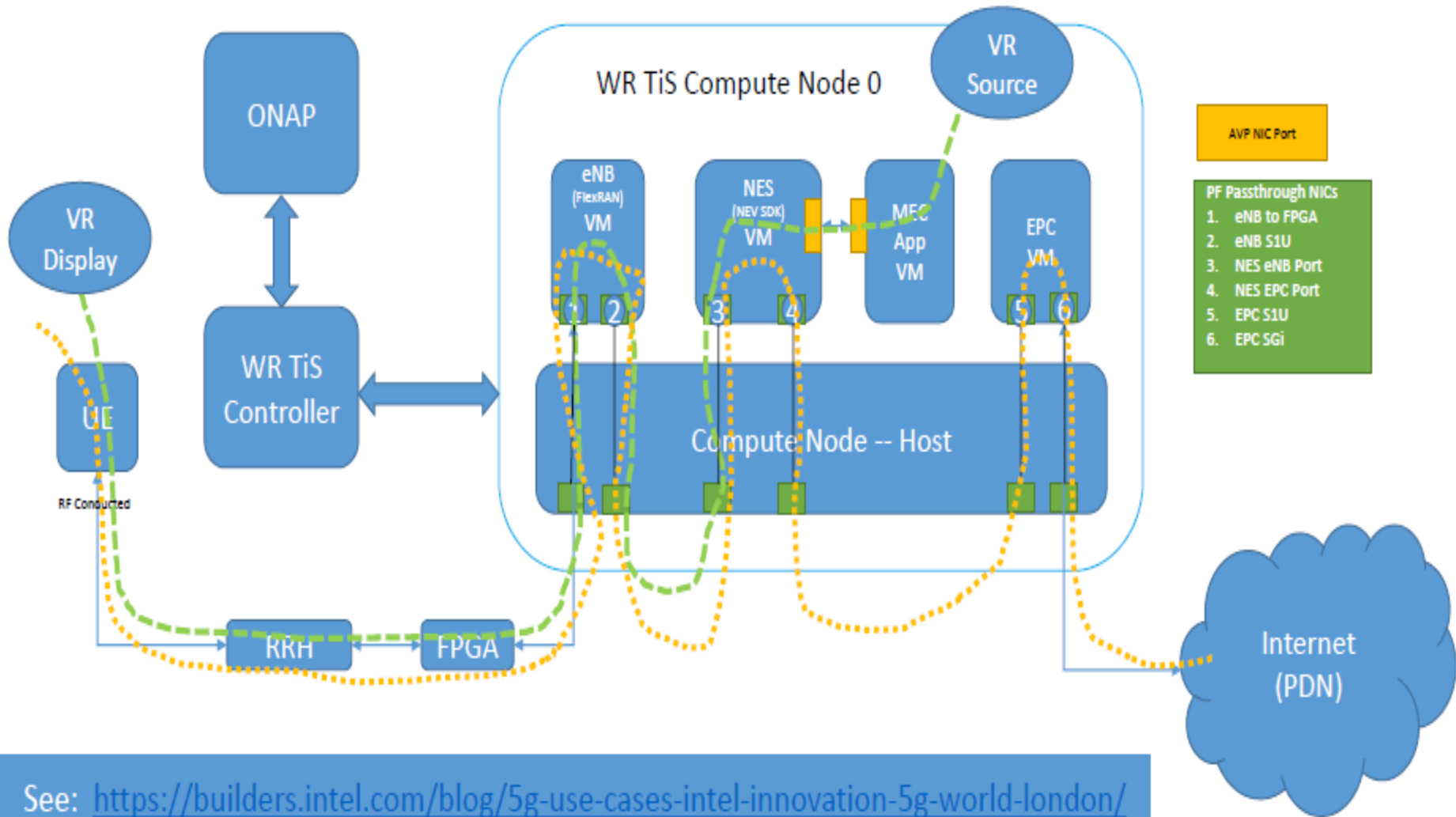



**FILE: ONAP Offline Deployment (PPTX)**

# ONAP Offline Deployment

ONAP Casablanca Developer Forum

June 21, 2018

# ONAP Offline Deployment

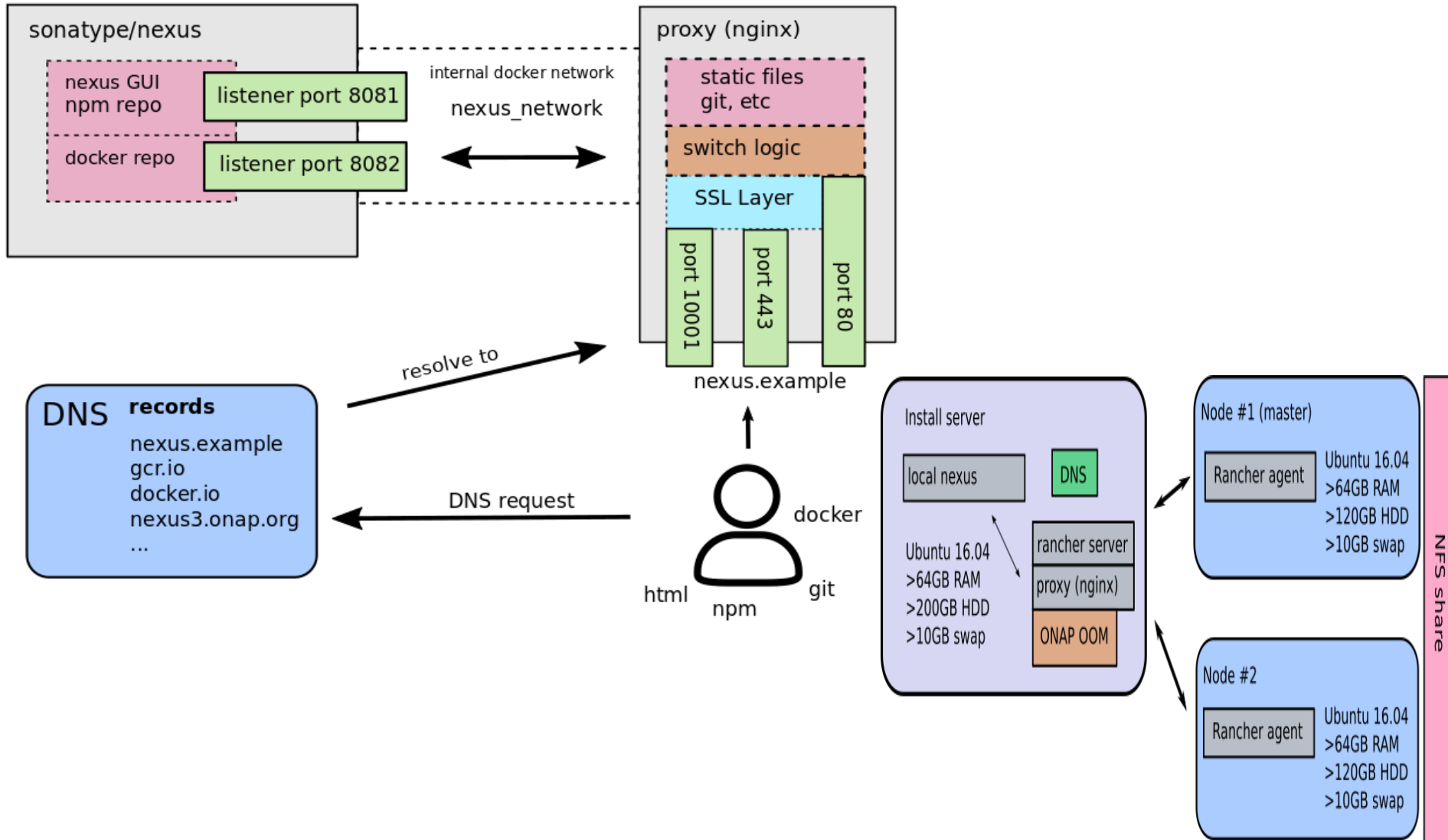





# BEIJING R2 RETROSPECTIVES



**FILE: ONAP Beijing Lessons Learned v1 (PDF)**

# ONAP Beijing Lessons Learned

[@Catherine Lefevre](#), [@Gildas Lamilis](#),  
[@Seshu Kumar M](#), [@Eric Debeau](#), [@Alla Goldner](#),  
[@Helen Chen](#),  
[@Chris Donley](#), [@Stephen Terril](#), [@Kenny Paul](#),  
[@Jason Hunt](#), [@Brian Freeman](#), [@Tim O'Keefe](#)  
Alex Vul, [@ramki krishnan](#)

ONAP Casablanca Developer Forum

June 20, 2018

# Items Covered

- Communications
  - Rocket Chat, WikiHelp
  - Sub-committees > TSC
  - Sub-Committees
- Labs and Test Environment
- Release Management
  - Grouping,
  - Milestones
  - Pair-wise Testing
- Jira
  - PTL Owners, JIRA Workflows
- Code Review
  - Requires active committers and more active code reviewers
- Development Infrastructure



**FILE: R2 Use Case CMCC Retrospect and Prospect v1.2 (PPTX)**

# R2 Use Case CMCC Retrospect and Prospect

China Mobile: Yan Yang  
Huawei: Yang Xu, Zhenhua Wang

ONAP Casablanca Developer Forum

June 21, 2018

# VoLTE Test Cases

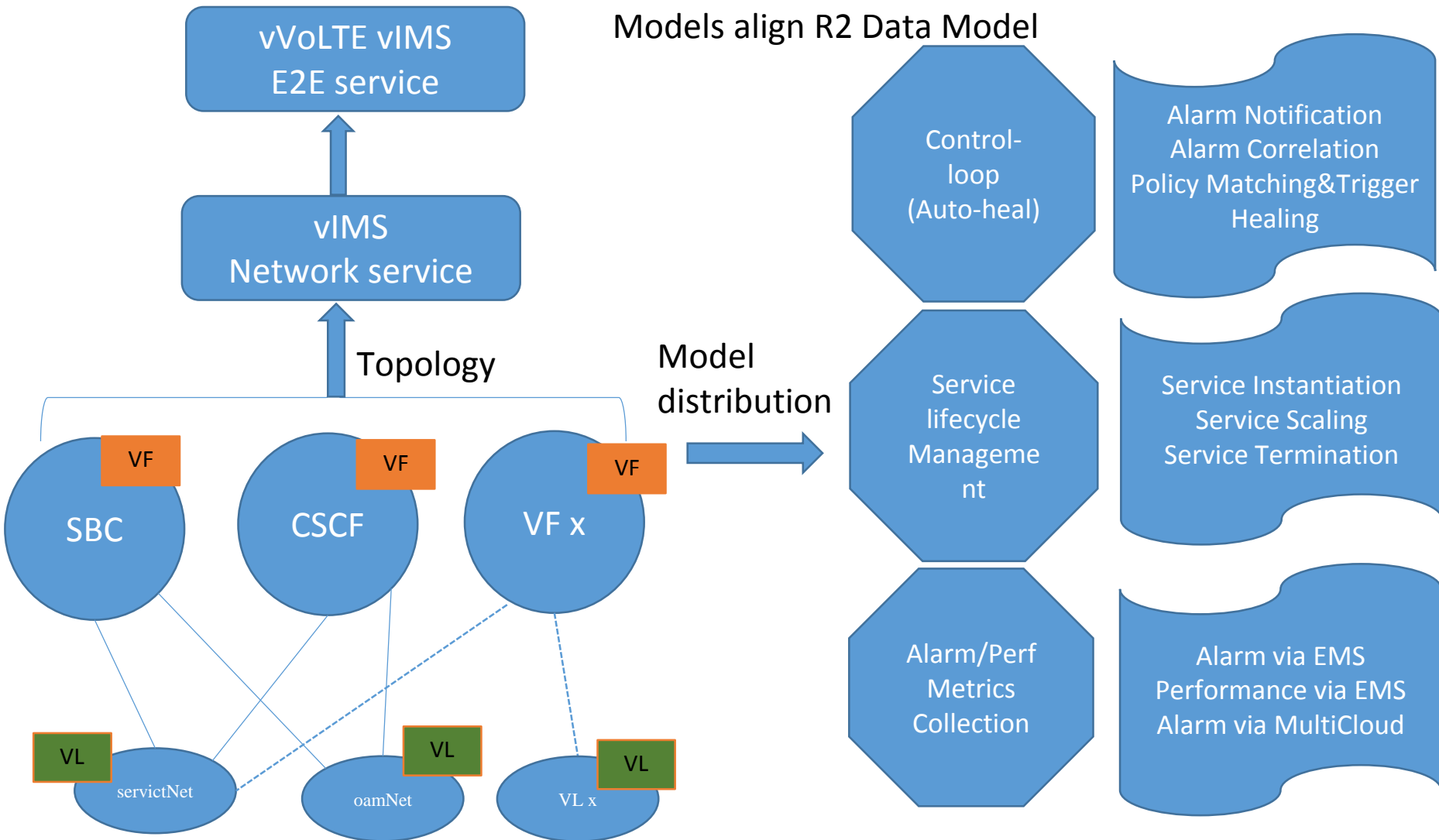



# MISCELLANEOUS TOPICS



**FILE: 6.19\_Resource IM requirements-2 (PDF)**

# Future Prospects on R3+ Resource IM Requirements

Chuyi Guo

# CCVPN Requirements

## CCVPN IM proposal

### CCVPN Target Solution

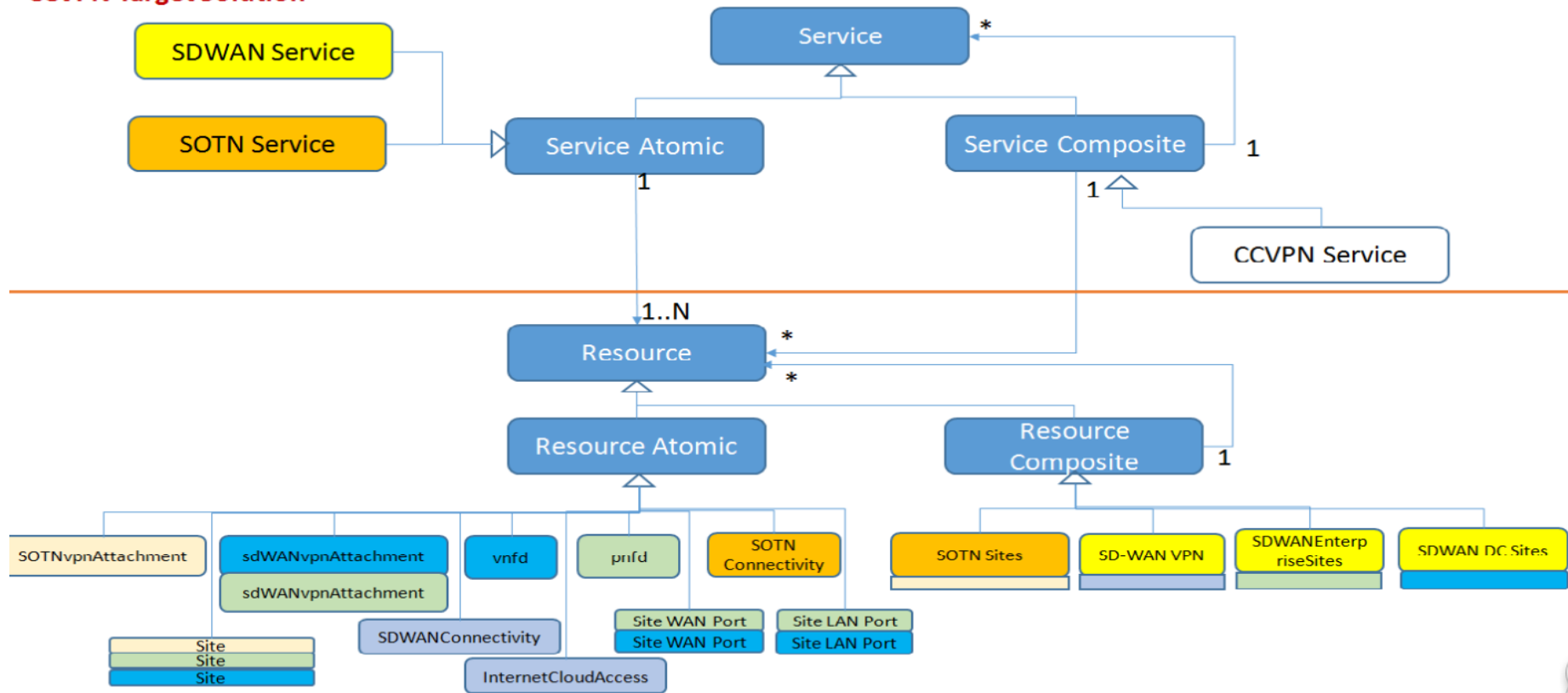

### Build CCVPN resource IM

- A unified modeling management on PNF devices
- A unified modeling management on the hierarchical topology of the L1 link in the transport network





**FILE: ONAP Attack Vector Analysis – Overview of the Process (PPTX)**

# ONAP Risk Assessment – Preparation Material

ONAP Casablanca Developer Forum

June 21, 2018

# Risk Assessment

The purpose of **Risk Assessment (RA)**: produce a prioritized list of security improvements

Identify risks

Rate the identified risks

Recommend treatment for the risks with unacceptable high level

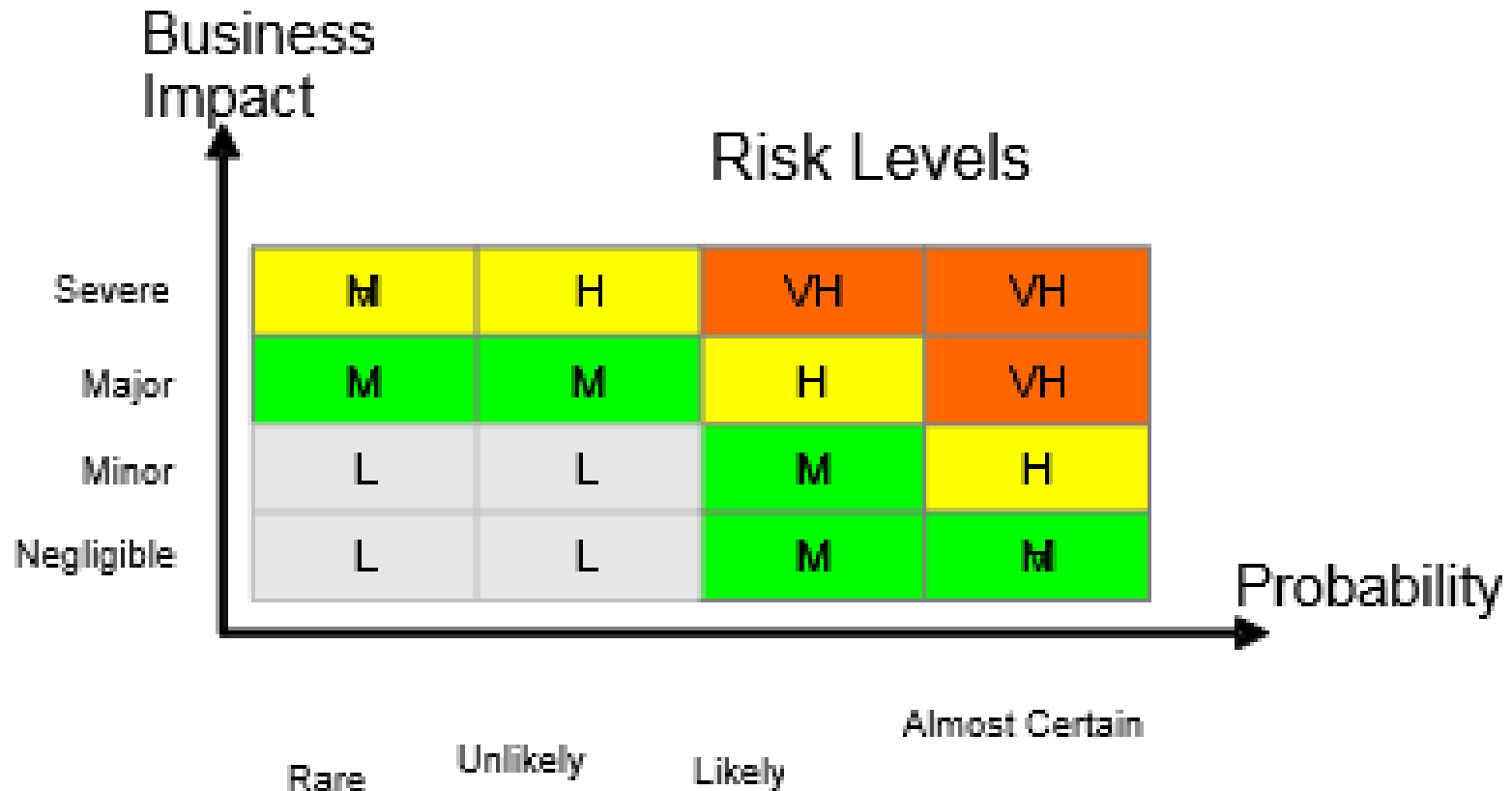



**FILE: POMBA Introduction (PPTX)**

# POMBA An Introduction

## Jason Hunt

ONAP Casablanca Developer Forum

June 21, 2018

# Post Orchestration Model Based Audit

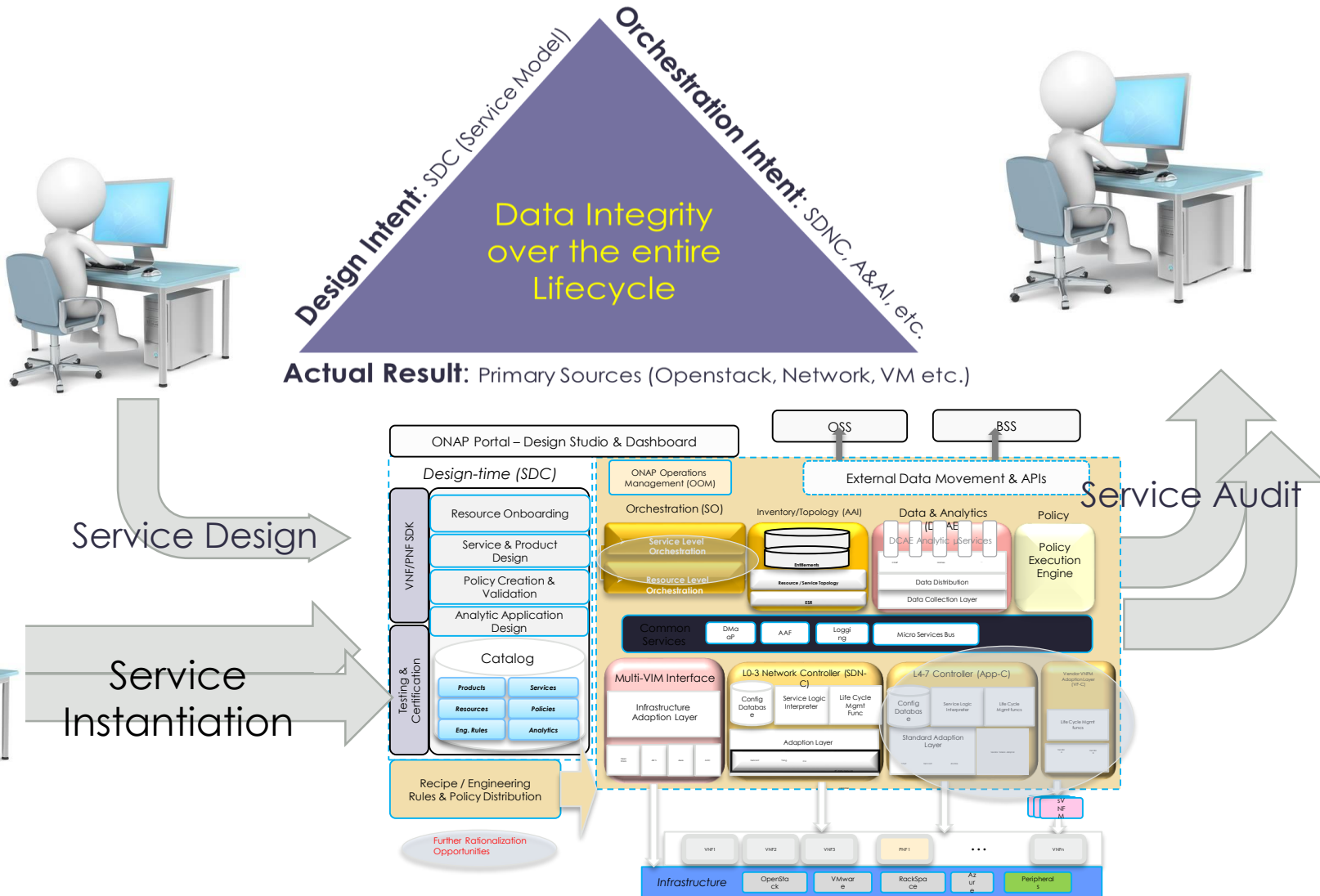



**FILE: S3P Improvements (PPTX)**

# S3p improvement for Closed loop network service resilience

China Mobile: Yang Yan  
VMware: Xinhui Li, Bin Sun

ONAP Casablanca Developer Forum

June 21, 2018

# Alert/Event/Meter Federation Framework

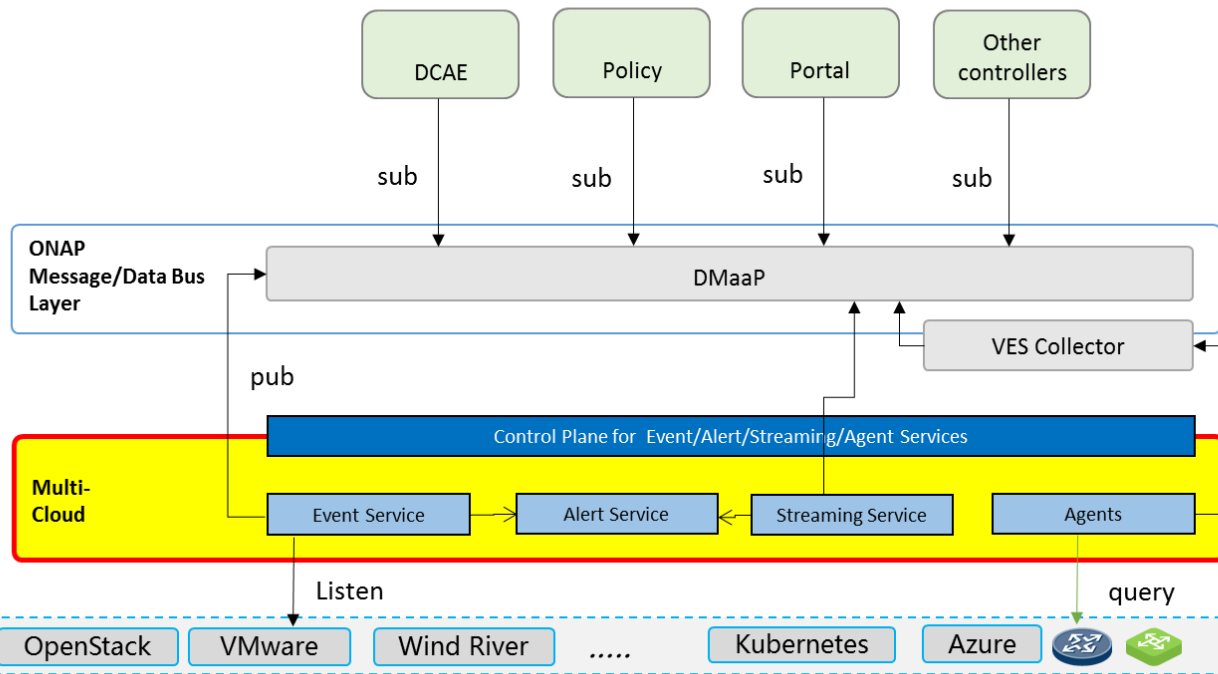

## • Event Service

- Federate events from different VIM providers with ONAP Message/Data bus services
- Allow to be configured by the control plane about listener and endpoints
- Not only events of different backend clouds, but also events from VIM controllers

## • Streaming Service

- Federate meters from different VIM providers with ONAP Message/Data bus services
- Allow to be configured by the control plane about gate rate and water mark
- Achieve a ideal long term output rate which should be faster or at least equal to the long term data input rate

## • Alert Service

- Alert comes from meters or events, or pre-defined in different backend Clouds
- Allow to be customized