



ONAP PNF Plug and Play

- ONAP and PNF Plug and Play for 5G RAN
- 5G Use Case Team

PNF Plug and Play Stages

Design Time

A



PNF Modeling

Resources Definition/Services Definition
SDC: PNF (physical element) Modeling
Distribution of types



B



PNF Instance Declaration

PNF Infrastructure Service Declaration
First part of PNF instantiation
DCAE & AAI Entry with PNF ID (e.g. MAC address)



C



PNF Boot-strapping

PNF Powers up and Boot-straps
PNF performs a "Plug and Play" procedure
Equipment vendor proprietary steps

D



PNF Contacts ONAP

PNF connects to ONAP via a Registration Event
PNF Registration Handler (PRH) processes the event
Generic (not vendor proprietary)

E



PNF Activation

Connection points configured
Second part of PNF service instantiation
Software is downloaded to PNF.
PNF configured and ready to provide service

Run-Time (Instances)

ACTORS	DESCRIPTION
PNF	PHYSICAL NETWORK FUNCTION (PNF) – The Distributed Unit (DU) or Network Hardware device that provides service to an end-user.
DHCP	DYNAMIC HOST CONFIGURATION PROTOCOL (DHCP) – Protocol to assign IP addresses to a network element (NE). The IP address can be dynamically assigned or static based on MAC address of PNF.
SEGW	SECURITY GATEWAY – Used to set up IPSec tunnels to protects against unsecured traffic entering an internal network of a operator; used by enterprises to protect their users from accessing and being infected by malicious traffic.
CA/RA	CERTIFICATE AUTHORITY / REGISTRATION AUTHORITY – Used to generate a service provider certificate for the PNF.
Initial EM	INITIAL EM – Provides basic configuration and software download services to the PNF. This might be a equipment vendor specific solution. Also, responsible for identifying a PNF.
vDHCP	vDHCP – An entity that exists outside of ONAP, it can assign and manage IP Addresses. Defined in the vCPE Use Case.
vAAA	vAAA (AUTHENTICATION, AUTHORIZATION, ACCOUNTING) – Authentication for a PNF to controlling access to the system, enforcing policies, auditing usage. An entity that exists outside of ONAP; defined in the vCPE Use Case.
SDN-C	SOFTWARE DEFINED NETWORK CONTROLLER (SDN-C) – A controller for Layer 0 to 3 devices. Manages transport and network connections.
DCA&E	DATA COLLECTION, ANALYTICS AND EVENTS (DCAE) – Gathers performance, usage, and configuration data from the managed environment. Collect, store data and provides a basis for analytics within ONAP. For PNF Plug and Play can potentially perform analytics on the Plug and Play process, statistics, logs.
A&AI	ACTIVE & AVAILABLE INVENTORY – The PNF is identified as available inventory and tracked through a key which is the PNF ID. When onboarded the PNF gets an entry in A&AI and can then be tracked, requested, and seen by the ONAP components for service requests or other queries.
SO	SERVICE ORCHESTRATOR – Serves as a mediator and coordinator of service requests.
APP-C	APPLICATION CONTROLLER (APP-C) - A controller for Layer 4 to 7 applications. Manages the life cycle of virtual applications, virtual network functions (VNFs), and components. APP-C manages the 5G DU & 4G DU.
PNF Discovery Manager	PNF Infrastructure Manager – is a Micro-Service used during the PNF Plug and Play process to receive and process the DMaaP topic (for the PNF VES event)

Design Time

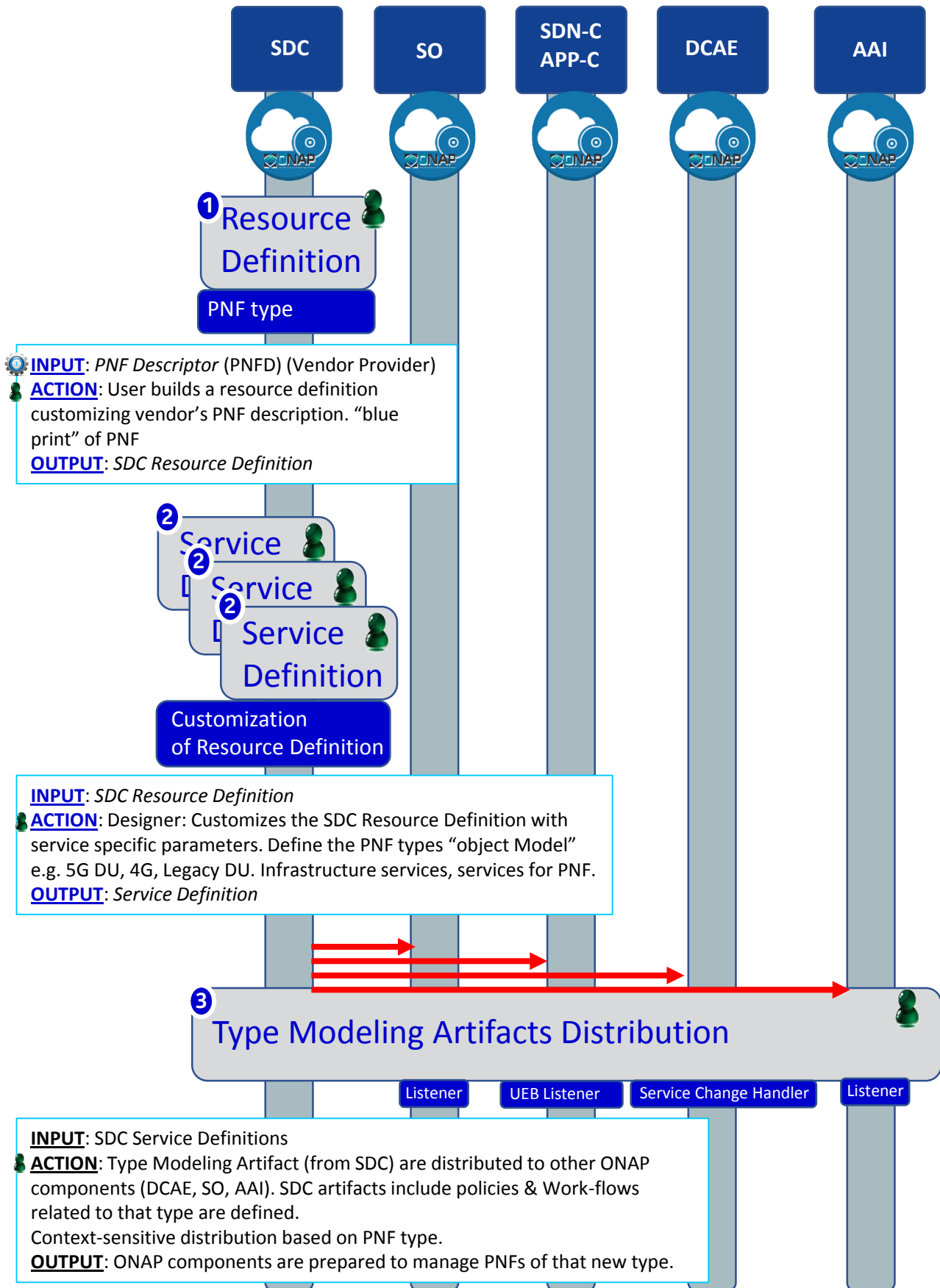

STEP	DESCRIPTION
1	<p>RESOURCE DECLARATION – A user on the VID performs a Resource Declaration. This uses the Service definition created in SDC. The user on the VID can define known information about the PNF. The user can (optional) provide the following information</p> <p>PNF RESOURCE Definition</p> <ul style="list-style-type: none"> Resource Type – Type of Resource. NEW type: PNF (pre-defined in SDC) NAME – Name of the PNF type CATEGORY – e.g. Infrastructure TAGS – User-definable tags (default name of the PNF) DESCRIPTION – Textual description CONTACT ID – Designer (user of ONAP) VENDOR – PNF Vendor (e.g. Nokia) VENDOR RELEASE – Vendor release VENDOR MODEL NUMBER – PNF Model value (link to A&AI) EVENTS – Monitoring Event definitions. Define design-time templates. CLAMP (runtime monitoring), DCAD (design time design template attach to VNF). Define templates & attach them. <p>Note: The user may provide whatever information in the above fields they know. Note: Consumer vs Enterprise deployments. Consumer systems pre-registered, distributed throughout a region. For a consumer deployment you might not know the MAC address/Serial number (PND IF) until the PNF connects to ONAP.</p>
2	<p>PNF SERVICE Definition</p> <ul style="list-style-type: none"> NAME – Name of the Service (mandatory) CATEGORY – e.g. Network L1...L4, VOIP call Control, Mobility TAGS – User-definable tags (default name of the PNF) DESCRIPTION – Textual description of service (mandatory) CONTACT ID – Designer (user of ONAP) (mandatory) PROJECT CODE – ID (mandatory) Ecomp-Generated Naming – Name Naming Policy – Policy to be used to assign a name to a service by SO/SDNC SERVICE TYPE – Type of service SERVICE ROLE – The Role of this service. ENVIRONMENTAL CONTEXT – distributed environments Specific Service(?) – PNF, allotted resource from a CU Service <p>The “basic” model are extended. Inherit (OO) from existing model. Vendor takes standard node types and creates their own extension.</p>
3	<p>DISTRIBUTION – Event Monitoring Templates distributed. (?)</p>

PNF Resource Declaration (future)

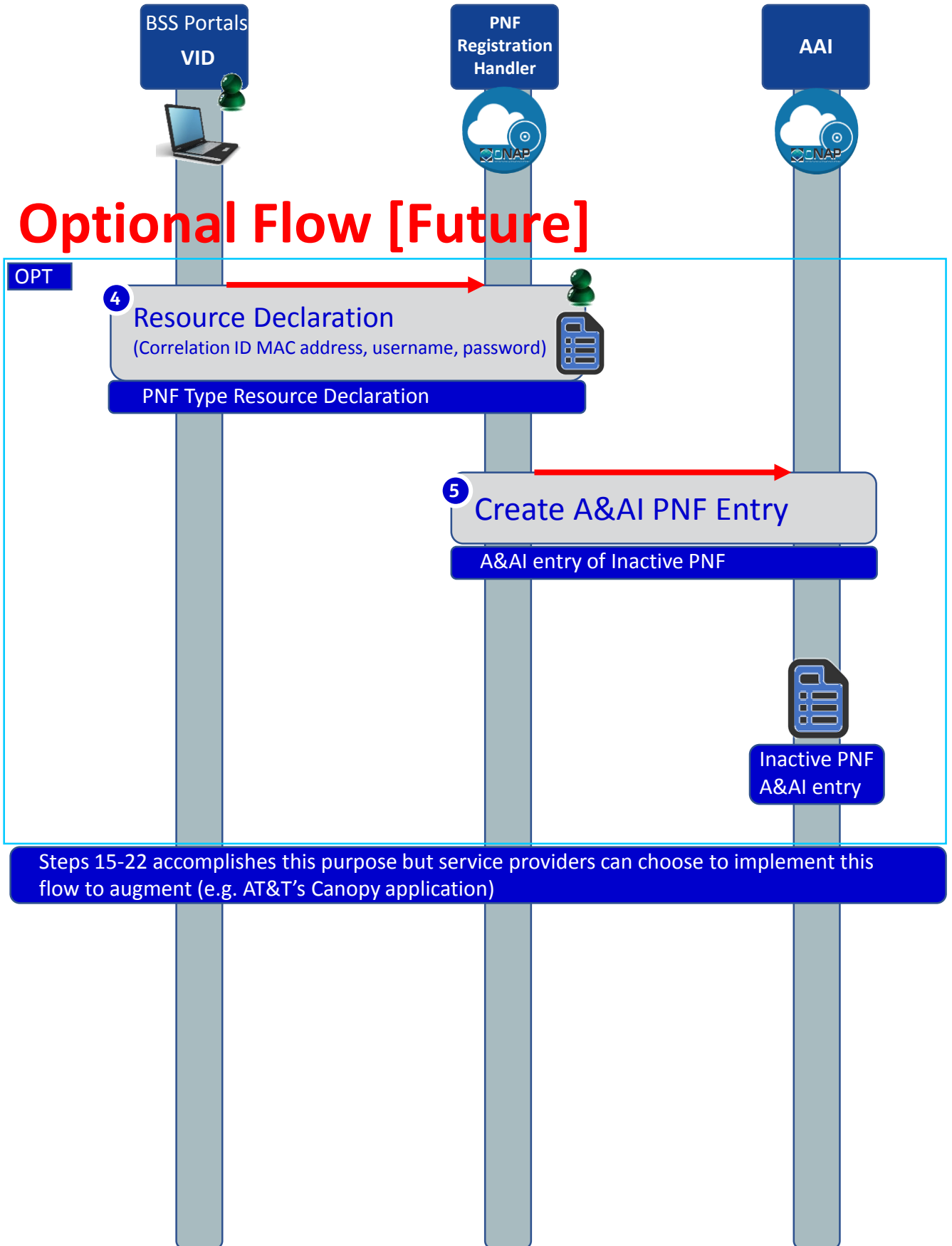



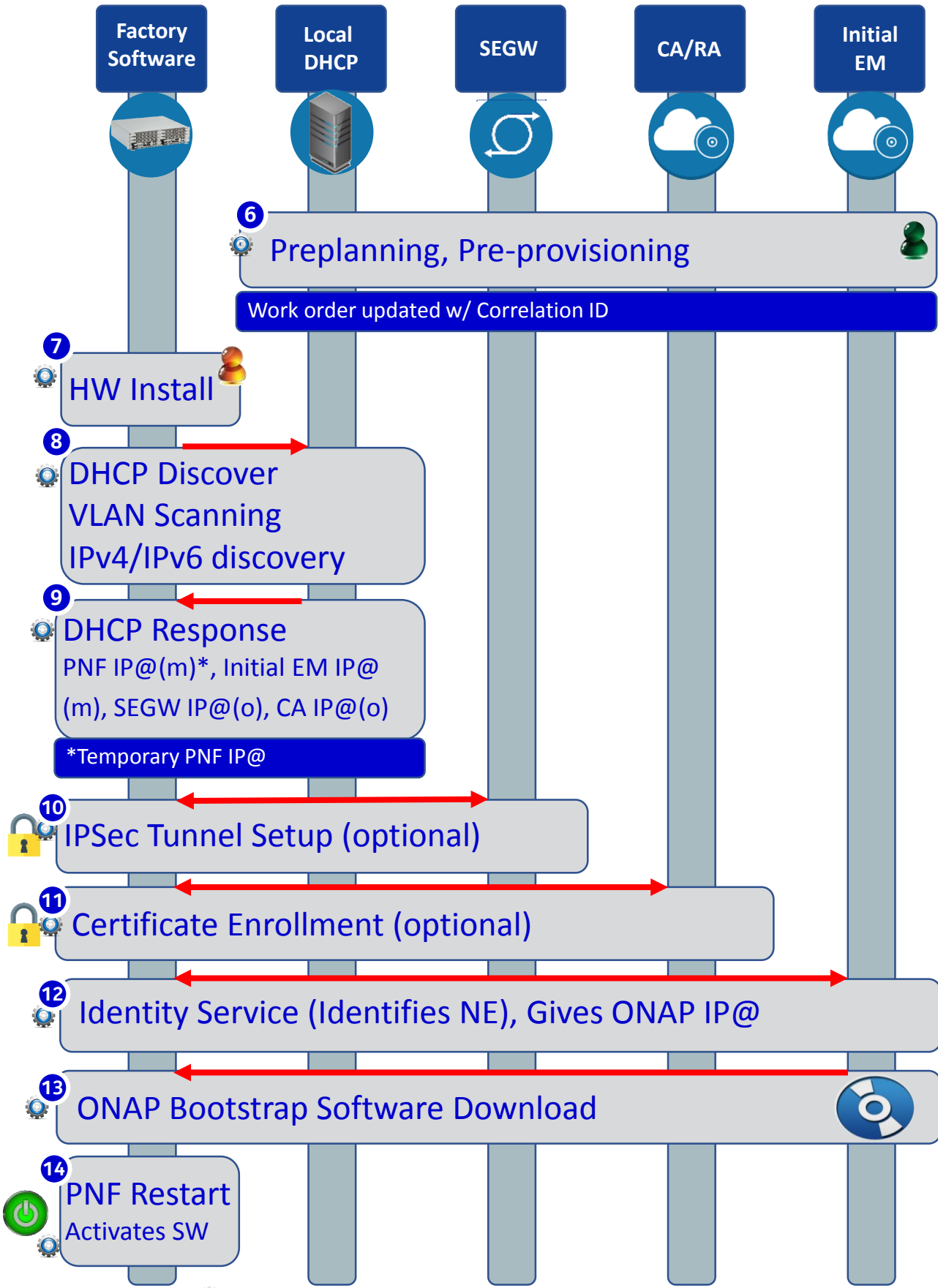



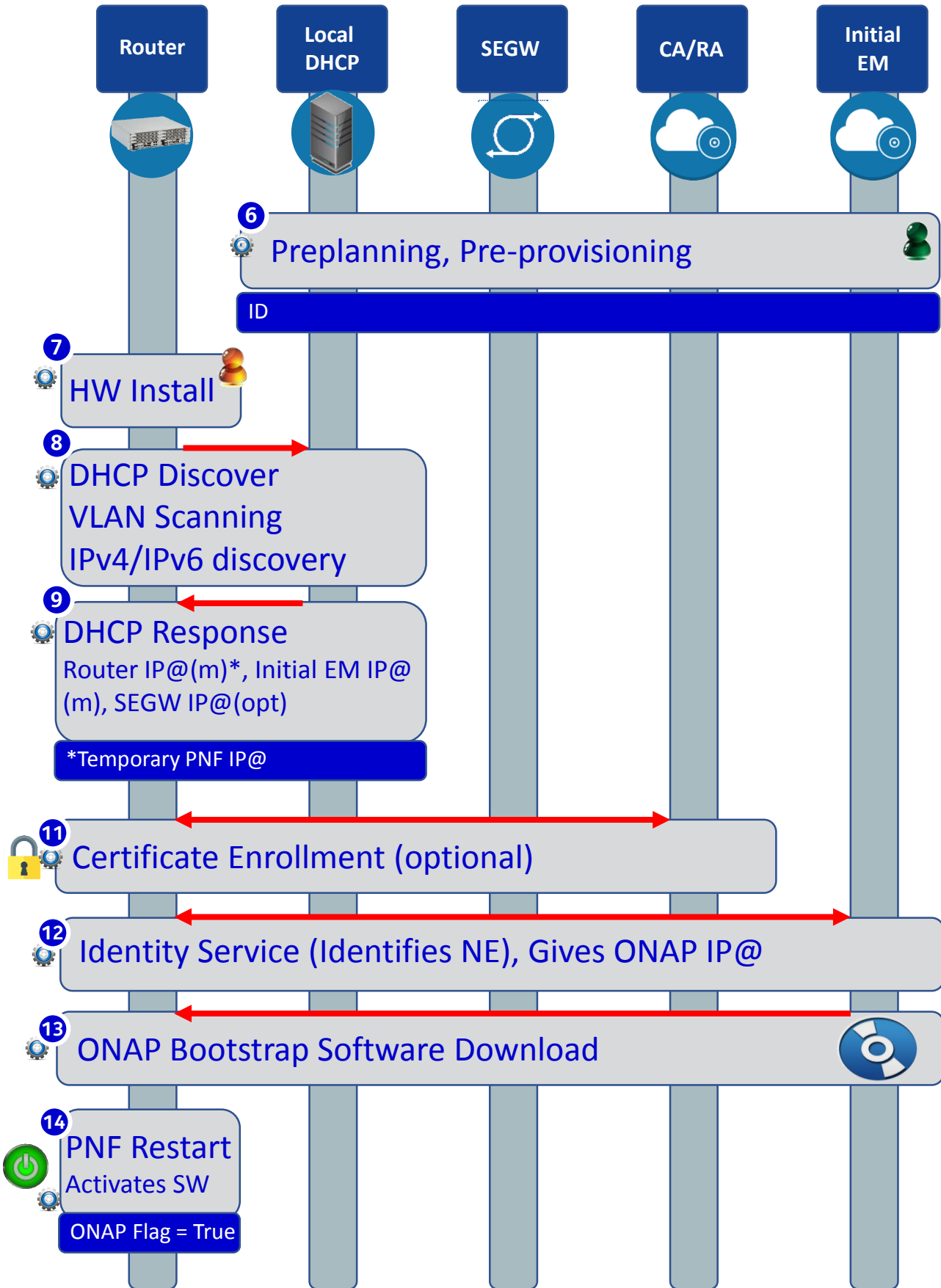

PNF Bootstrapping Steps (for 5G DU)





PNF Bootstrapping Steps (for Routers)

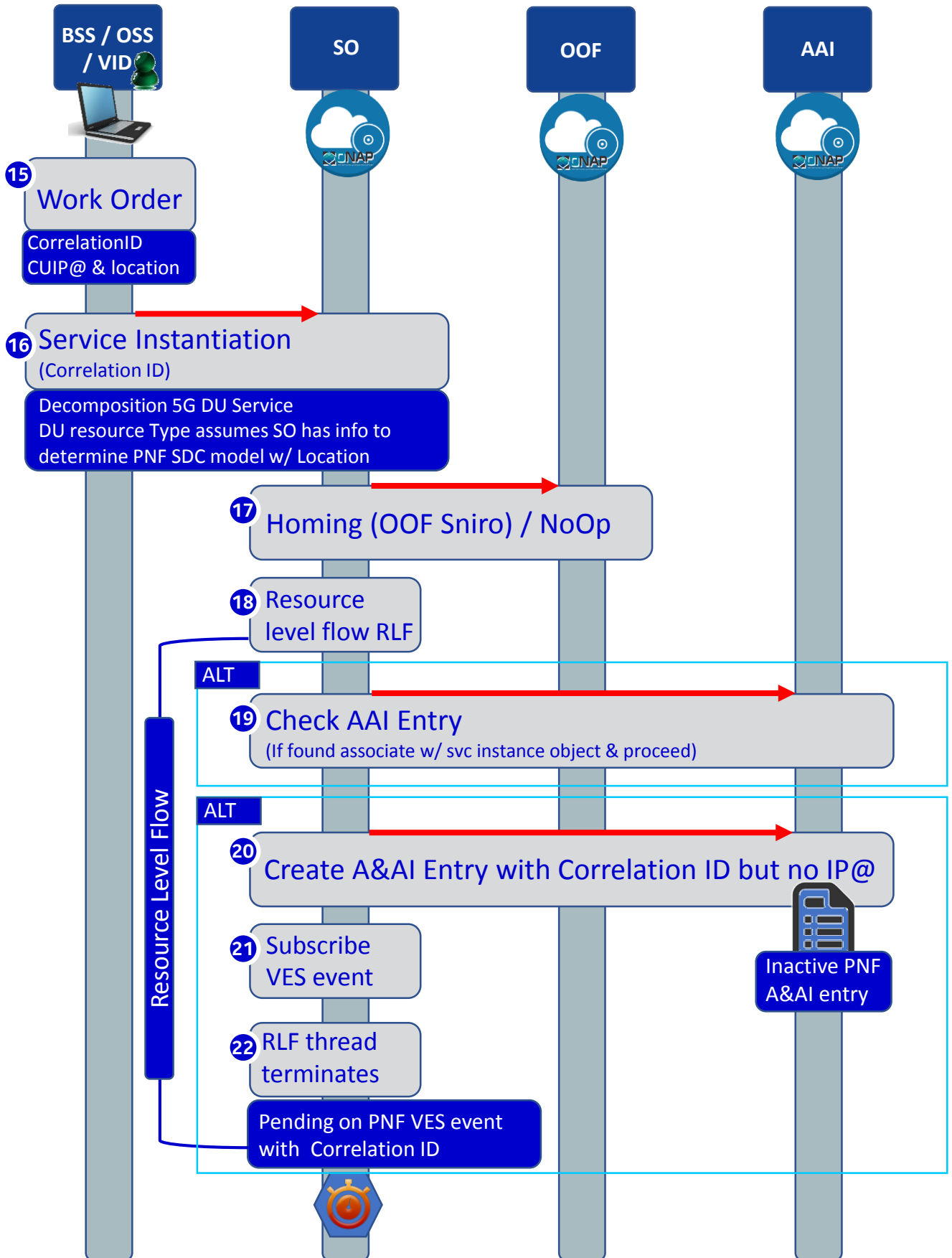

STEP	DESCRIPTION
6 	<p>PRE-PLANNING, PRE-PROVISIONING – There is data which is programmed into the system for the PNF Plug and Play operation. The user programs the local DHCP IP address(@), the Security Gateway IP@, the CA/RA certificate information, the management plane IP address (the ONAP IP@), the software service IP@ for use by the PNF during the onboarding process.</p> <p>Note: <i>The CU is instantiated ahead of time with the expected DUs that it should be connected to (that is outside the scope of this flow).</i></p> <p>Note: The user name & password which the PNF needs to know to contact and get through the vAAA server before it contacts ONAP.</p>
7 	<p>HW INSTALL – The physical hardware is installed at the site. Site licensing, real estate contacts, zoning, and physical hardware of the PNF is installed by technicians. Power, backhaul, and antennas are installed and connected.</p>
8 	<p>INITIAL NETWORK ACCESS – A DHCP Discover procedure is executed when the PNF powers on, VLAN Scanning is performed, and IPv4/IPv6 discovery is done. The DHCP Discover message exchange provides an entryway into the network and is designed as an procedure for a network element to be able to find connection to the network from “scratch”. VLAN Scanning and IPv4 vs IPv6 discovery is done as well.</p>
9 	<p>DHCP RESPONSE – The DHCP response returns a PNF IP address, the initial EM IP address, Security Gateway IP address (optional), and certificate authority IP address (opt). It is possible the PNF IP address is a temporary IP address used for initial connectivity purposes, and that a permanent PNF IP address will be granted later.</p>
10 	<p>IPSEC TUNNEL – An IP Sec Tunnel is established which uses cryptography to provides a secure connection. IPSec has two security services: Authentication header and an encapsulating security payload with tunnel and transport modes.</p>
11 	<p>CERTIFICATE ENROLLMENT – The process where the PNF gets a service provider certificate from the Certificate authority. The certificate is then used to authenticate and verify the PNF.</p>
12 	<p>IDENTITY SERVICE – The identity service is there to identify the PNF. It also returns the ONAP (DCAE) IP address.</p>
13 	<p>ONAP BOOTSTRAP SOFTWARE – The PNF contacts the initial EM and downloads the ONAP Bootstrap software. This is a software package that is meant to perform the remaining steps of PNF registration and activation onto ONAP</p>
14 	<p>PNF RESET – The PNF is reset so that the downloaded ONAP Bootstrap software becomes activated and is then ready to continue to PNF registration</p>

Service Instantiation Process (Part 1)



#	DESCRIPTION
15	WORK ORDER – The work order determines which PNF to use for this Service/work order. BSS is told the correlation ID. Typically, the PNF will be known before the PNF comes on-line. Orchestrated with a equipment order (to vendor) and location value for the PNF.
16	SERVICE INSTANTIATION – The user on the VID creates a service instantiation providing a correlation ID. The service is decomposed for a 5G DU PNF. The DU resource types assumes that there is enough information to determine the PNF SDC model. The CU IP@ is provided manually (as part of service instantiation data).
17	HOMING – The SO instantiation is homed with the OOF. Dependencies stated on PNF. The homing latency constraints are based on CPE address (location). As part of the service definition a latency needs to be less than [x]. This is a service constraint. Homing dependencies should come from SDC or VID. PNF homes to a CU. [FUTURE] Homing identifies the place where a VNF is instantiated. For PNF there is no “cloud” resources needed (CU); ONAP instantiations/data-centers want to define which ONAP instantiation takes care of a PNF [FUTURE].
18	RESOURCE LEVEL FLOW (RLF) - The resource level flow thread starts. This thread is responsible for carrying out the creation of an A&AI entry in the following steps (steps 18 through 21).
19	CHECK A&AI ENTRY – The RLF thread in SO checks the A&AI entry for the PNF. If SO discovers that there is an A&AI entry with both the correlationID and the PNF IP@ then it can continue. If found it can associate it with the service instance.
20	CREATE A&AI ENTRY – A&AI entry created by SO for PNF using the available information and the correlation ID. This is done in anticipation of the PnP PNF VES event.
21	CREATE DMaaP TOPIC LISTENER – The RLF thread (process) subscribes to the DMaaP Topic that will complete the service instantiation. It allows ONAP to intercept the VES event that will eventually come from the PNF when it reaches a point in the PNF Plug and Play process that it is ready to contact ONAP. The RLF specific resource thread indicates that it cares about the VES event with this correlation ID. Essentially it activates a “listener” of the PNF VES event. DCAE is the normal VES event Listener which creates a DMaaP Topic. SO saves the state information looks and sees if it is one of the DMaaP topics it is waiting for.
22	RLF THREAD TERMINATES – The Resource Level Flow (RLF) thread in SO terminates. When the VES event is received at a later point in time, it can be processed accordingly. Additionally, these steps 15-22 prepare ONAP with the pre-requisite information so that when the VES event comes from the PNF it will not be discarded. This is denoted by stopwatch icon  . At a later step in the PNF Plug and Play this thread becomes relevant again at the other stopwatch icon. The RLF thread/process stops processing and wait for an asynchronous event (to avoid a long running event). Writes a process, kamunda handler for an event that rehydrates it. (this reuses the SO rainy day handling)

Service Instantiation Process (Part 1)

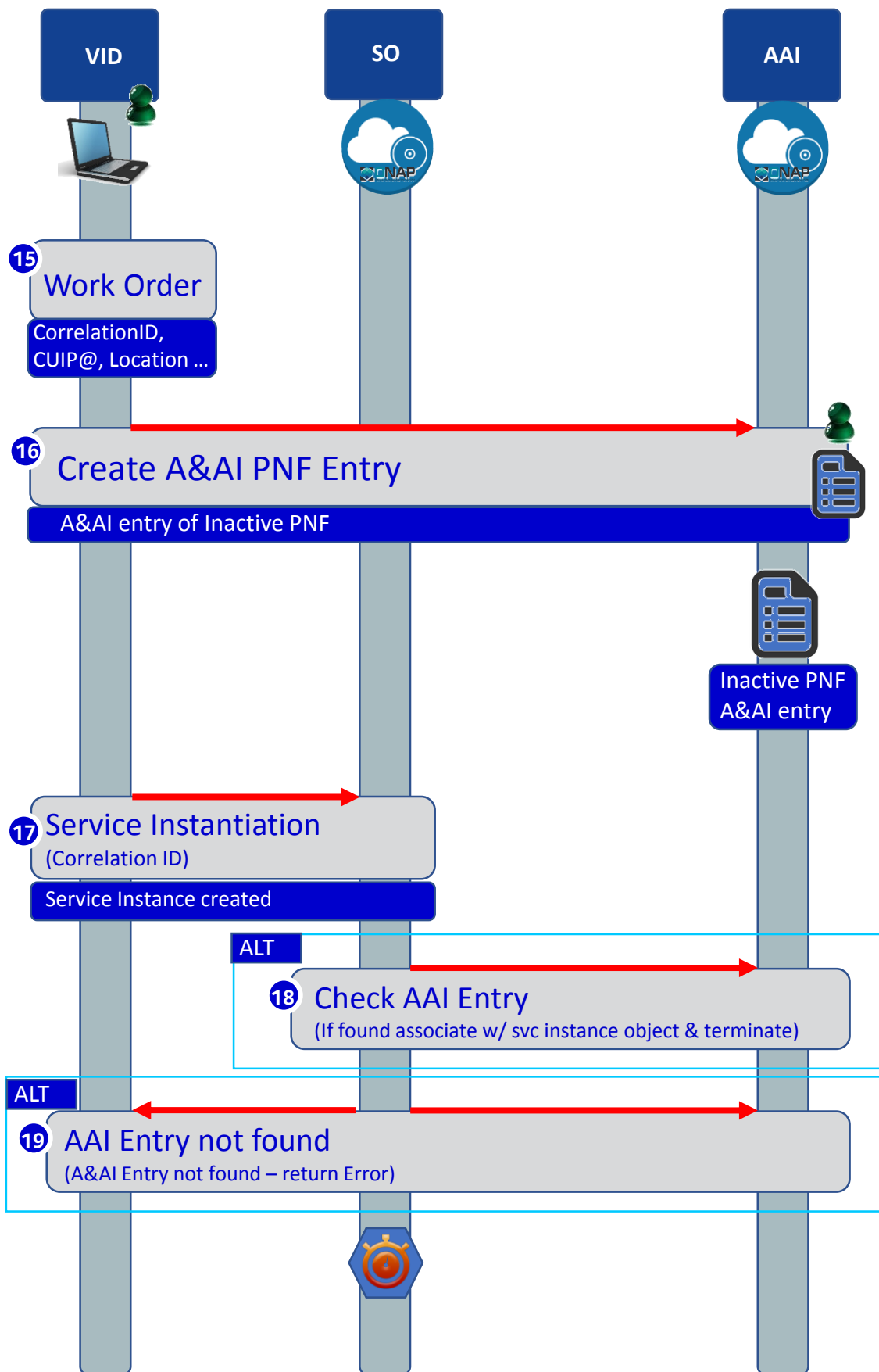

STEP	DESCRIPTION
15	WORK ORDER – The work order determines which PNF to use for this Service/work order. BSS is told the correlation ID. Typically, the PNF will be known before the PNF comes on-line. Orchestrated with a equipment order (to vendor) and location value for the PNF.
16	CREATE A&AI PNF ENTRY – From the resource declaration information, a A&AI PNF entry is made. The A&AI entry uses the information provided on the VID such as the PNF ID, SW, Config, Username, Password and Events. This Resource declaration allows for a VES event coming from the PNF later to recognize the PNF and not drop the VES event “on the floor”.
17	SERVICE INSTANTIATION – The user on the VID creates a service instantiation providing a correlation ID. The service is decomposed for a 5G DU PNF. The DU resource types assumes that there is enough information to determine the PNF SDC model. The CU IP@ is provided manually (as part of service instantiation data).
18	CHECK A&AI ENTRY – The RLF thread in SO checks the A&AI entry for the PNF. If SO discovers that there is an A&AI entry with both the correlationID and the PNF IP@ then it can continue. If found it can associate it with the service instance.
19	CREATE A&AI ENTRY – A&AI entry created by SO for PNF using the available information and the correlation ID. This is done in anticipation of the PnP PNF VES event.

PNF Registration Steps

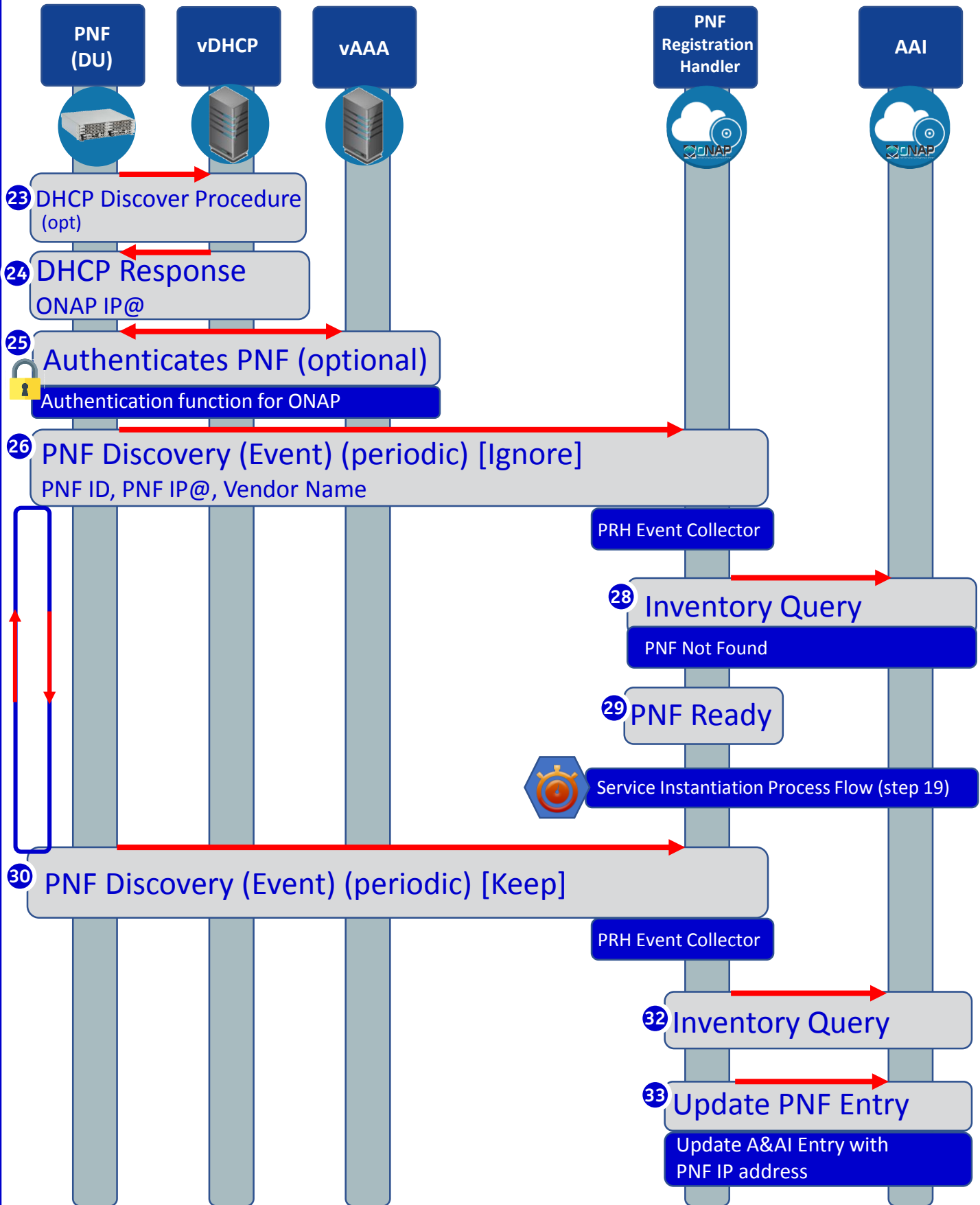

STEP	DESCRIPTION
23	DHCP Request –ONAP Onboarding S/W performs a DHCP procedure with vDHCP
24	DHCP Response – DHCP response returns a ONAP IP address
25	Authenticate PNF – The PNF is authenticated through a vAAA.
26 & 30	PNF DISCOVERY – The PNF periodically generates a VES Event to DCAE which is the “triggering” event that tells ONAP that the PNF is trying to register. This VES event contains the Correlation ID (based on the PNF ID), which will serve as an identifying key within A&AI to seek for that particular PNF. The VES event also contains the PNF IP address and the vendor name amongst other things. PNF sends the VES Event over an HTTPS connection which must be authenticated with a username and password. The VES Event is “standardized” and is the same for all hardware (PNF) irrespective of equipment vendor, thus there needs to be ONAP bootstrapping software. The PNF must natively support or have an adapter to be ONAP capable. Note: The <i>PNF Infrastructure Manager</i> may evolve in the future to include other management functions, as there may be a need for an entity that owns the interactions with device interactions w.r.t. ONAP. Management of devices vs containers. I/F manages & consumes services. VIM/Multi-Cloud. Multi-VIM PNF plugin. Multi-VIM would call the PNF infrastructure manager.
27 & 31	DMaaP EVENT – When DCAE receives the VES event, DCAE generates a DMaaP event. This then publishes the VES event into the proper Kafka topic. PNF Discovery Manager subscribes for these types of events and so is notified when one is published. This VES event indicates that a new PNF has been identified.
28 & 32	INVENTORY QUERY – PNF Discovery Manager performs an inventory Query to A&AI using the Correlation ID (based on the PNF ID) as the key. The AAI instance for this PNF ID must have already been created. If it has, then this is a valid, expected PNF. If not, then this is not a valid, expected PNF. In Step 32, PNF A&AI entry is found.
33	PNF READY - PIM publishes a PNF Ready event on the DMaaP bus to which SO subscribes. SO receives the PNF Ready event, determines that it is an event it is waiting for and rehydrates the appropriate RLF to restart the Service Instantiation
(15-22)	SERVICE INSTANTIATION PROCESS (PART 1) – Steps 15-22, the Service Instantiation Process (part 1) occurs in parallel to these steps. When that process reaches the pending point (denoted by ) it rejoins the flow here. PNF previously declared.
33	UPDATE PNF ENTRY IN AAI – The PNF entry in AAI is updated with the PNF IP address. After this step, the PNF is considered to be active in ONAP and becomes available as an network element to fulfill service requests.

PNF Activation Steps (ONAP)

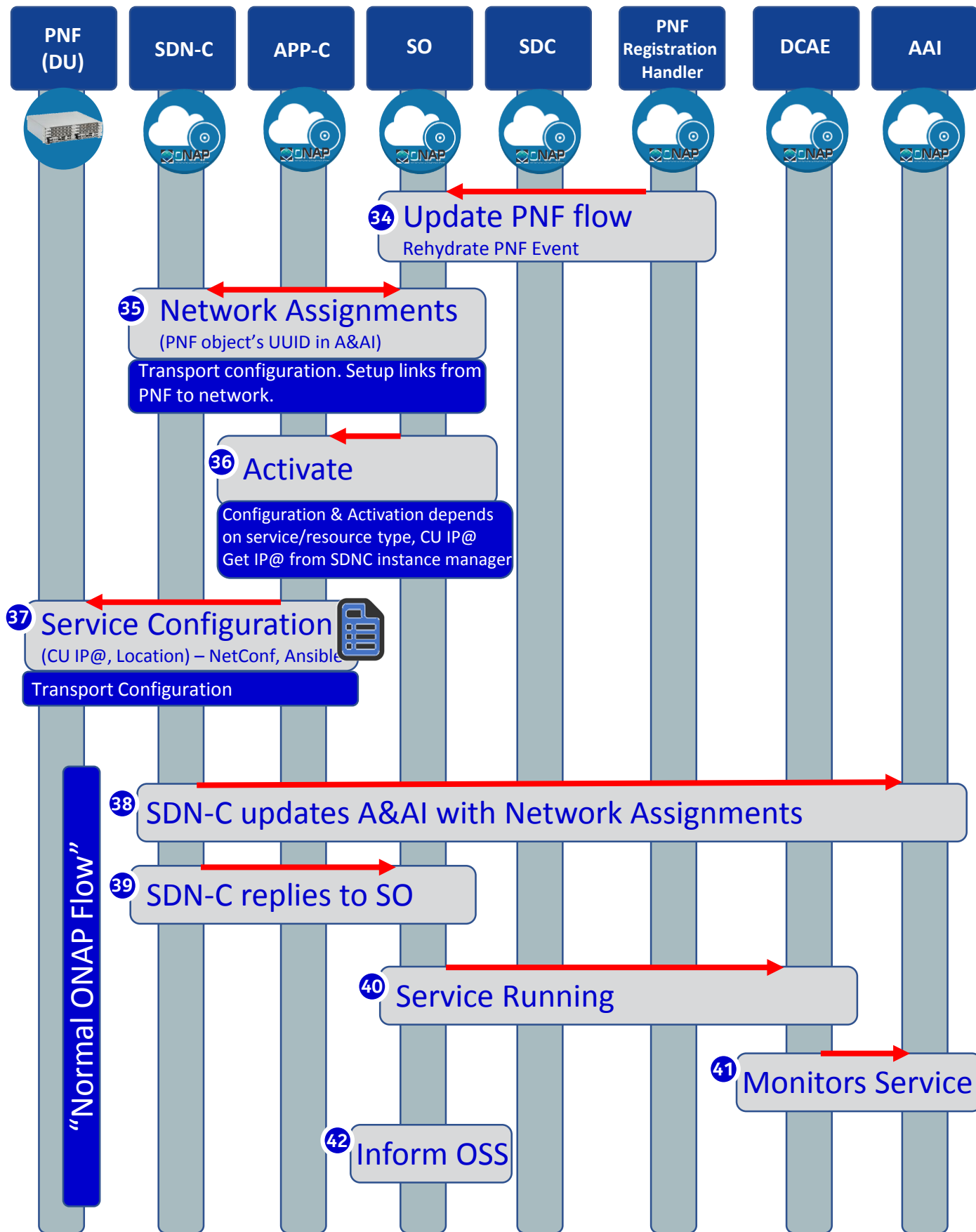

STEP	DESCRIPTION
34	SO NOTIFIED - PNF Infrastructure Manager Notifies SO. SO listens to the DMaaP hook. A trigger. Wait for PNF onboarded. Calls SDN-C.
35	NETWORK ASSIGNMENTS – SDN-C assigns an IP Address for SO. The IP @ assigned to the PNF is drawn either from the DHCP server, IP address Pool, or a Static IP@. Managing physical/virtual links to PNF. Between CU & DU. Transport connectivity setup. SDNC makes assignments, the resource model have external/internal connection points (named). For each point, attributes say L1/L2 connection. If L3 who assigns the IP address. Each point, SDNC knows if and what to assign. Set either through SDNC (L0-L3) or APP-C (L4-L7). Driven by TOSCA Model.
36	ACTIVATE – Configuration & Activation of the PNF Depends on the resource type. The controller requires input data based on PNF type. Either VF-C or APP-C orchestrate with SO. The IP@ is retrieved SDNC instance manager for PNF and the DHCP server may be updated. Pass on configuration parameters e.g. CU IP@
37	SERVICE CONFIGURATION – APP-C calls Ansible to configure PNF’s CU IP@. NetConf messages from SDN-C to PNF. (1) CU IP@ (mandatory) - VF-C/APP-C gives the Controller IP@ to the DU. In R2 for the 5G DU, this will also give the CU IP@ which will allow the DU to contact the CU to be configured for service. Eventually when the DU is managed directly from ONAP, this would be the APP-C, SDN-C or VF-C IP@ as appropriate. (2) OAM IP@ (optional) - The permanent OAM IP address is given to the PNF. The PNF would receive this IP address and use it. The IP address assigned from SDN-C may come from the vAAA, or it may draw from a local pool of IP addresses. SDN-C performs the IP address selection. It knows if a permanent IP address should be assigned to the PNF. Note: this IP@ assignment <i>optional</i> . (3) Transport configuration (optional) – Transport configuration is given to the PNF. (4) Location – the Location configuration is given to the PNF.
38	SDN-C Updates A&AI – SO updates A&AI with Network Assignments (from step 35)
39	SDN-C replies to SO – SDN-C replies to SO are the service configuration step.
40	Service Running – SO publishes a “Service running” event to which DCAE subscribes.
41	Monitors Service - DCAE reads A&AI entry and sets up monitoring for the new service. DCAE publishes “Service monitored” event to which SO subscribes. For monitoring events, the DU will be managed by the CU (in the FUTURE an M-Plane will be setup to ONAP to DU)
42	OSS Inform - SO responds to User/BSS/OSS that the service is active.

PNF Final Download & Activation (Vendor Specific)

PNF
(DU)



CU
(VNF)



42 Connection to Controller (DU contacts CU)

43 Target SW Software Download





Before CU/DU Split

44 DU Restart

45 CU configures DU with operational configuration

46 DU Restart

47 Ready for Service

STEP	DESCRIPTION
42 	<p>CONNECTION TO CONTROLLER – Using the CU IP@ from the previous step, the DU makes contact with the CU. If the CU cannot be reached, the DU shall periodically retry.</p> <p>Note: The CU has already been previously deployed and “plug & play” onboarded procedure before the DU wants to register. This is outside the scope of this use case.</p>
43 	<p>TARGET SOFTWARE DOWNLOAD - The new Target Software is downloaded which is the RAN specific software that will replace the ONAP Bootstrap software.</p>
44 	<p>DU RESTART –After the software successfully reboots, the Target Software becomes activated, and the PNF truly becomes a 5G DU (Distributed Unit).</p>
45 	<p>CU CONFIGURES DU – The configuration information is downloaded to the DU. This information provides operational configurations and settings which are vital for service. They would be pre-provisioned and allow the PNF to operate with specified configurations, optimizations, RF settings, connectivity, and L1/L2 algorithmic settings.</p>
46 	<p>DU RESTART – The PNF (DU) is reset, which allows the new configuration parameters to take hold. And the DU is ready to provide service using the configuration provided to it. Typically, a test call is performed to verify service is working end-to-end.</p>

PNF Plug and Play Projects Impacts

ONAP Project	IMPACT
Modeling, SDC, VNF-SDK	<ul style="list-style-type: none"> • (Existing: No Impact) PNF Update (if user wants to define a new version of the PNF, w/ additional artifacts, modeled as a wholly new [x] or update [x]) • SEND DATA TO PNF (Open Point) – Beijing Release Solution: Hardcode the CU IP@ (Data).
A&AI	<ul style="list-style-type: none"> • Register PNF Service – may need new registration information in AAA • (Step 20) INSTANTIATION an Instance has a “<i>pnf-name</i>” = Key in AAI. Could change it to the ID. E.g. “Name” = “abcd””ID#””#Code” (automated, NF naming code); <i>equip-type</i> (PNF Type). <i>equip-vendor</i> (optional); <i>equip-model</i> (optional); <i>pnf-id</i> (PNF ID) • (Step 33) ADDRESS UPDATE adds <i>ipaddress-v4-oam</i>; <i>ipaddress-v6-oam</i> ; (FYI/ <i>ipaddress-v4-loopback-0</i>). • (Open Point) what is a correlation-id (?) Unique key (Step 27) QUERY A&AI query exists. (no new development) PNF?=PNFID • Add PNF SERVICE FIELDS: <i>Manager IP@</i>, <i>mac-address</i> & <i>serial-number</i>,
ONAP Controller	<ul style="list-style-type: none"> • Provide CU IP@ to PNF as part of Service Instantiation • Determine the ONAP Controller
VNF Requirements	<ul style="list-style-type: none"> • REQUIREMENTS - Expand VNF requirements to add PNF requirements needed for this use case.
OOF	<ul style="list-style-type: none"> • (No Impact)
VID	<ul style="list-style-type: none"> • (Step 19) Create A&AI Entry via VID. • Create a NEW GUI, set the correlation ID, create A&AI Entry
Next Steps	<p>Jira Tasks</p> <p>Functional requirements for each Project</p>

PNF Plug and Play Projects Impacts

ONAP Project	IMPACT
PNF Registration Handler (PRH)	<ul style="list-style-type: none">• (Steps 27-34) PNF REGISTRATION HANDLER Plugin/Microservice): PRH is <i>new DCAE microservice</i> “plug-in” to be implemented. PRH Developed by Nokia MN (Mobile Networks) ONAP team w/ Lushen Ji<ul style="list-style-type: none">(1) COLLECT PNF REGISTRATION EVENTS (step 26, 30) - from a PNF sending PNF discovery registration event. [ALT] corruptions in event message. (error handling). PNF directly sends to PRH (without a DMaaP topic)<ul style="list-style-type: none">(2) UPDATE A&AI – Call A&AI API to query A&AI entry and update the entry. [ALT] A&AI rejects (error handling). The PRH will directly use the A&AI API.(3) CALL SO - Call “Update PNF Flow” in SO• PRH to PNF MESSAGING (Open Point) – What does a message from the PNF look like? Perhaps a VES-like message exchange? VES Heart-beat messages. Needs to have a “standard” format because it must be supported by various vendors. PRH must “wait” & receive the message from the PRH.<ul style="list-style-type: none">(1) GET MESSAGE FROM PNF to PRH (step 26, 30) – Expecting message to come directly from PNF, Will directly get the message (not using DMaaP) – might come through load-balancer. will know that IP address w/ this MAC-address is approved from PNF. When the PNF contacts PRH it is assumed to be ok (because it is assumed to be pre-authenticated). It was allowed to go to the DHCP server because vetting of vAAA. HTTPS. TLS. LDAP authenticates.• DEPLOYING PRH SERVICE IN DCAE PLATFORM - REST server packaged in Container. Cloudify orchestrator deploys containers. Yaml file defines Ports exports I/Fs. Dcae.gen2/platform/blueprints (yaml examples, VES collector). (Should be a “standard” deployment of a service onto DCAE platform).• DCAE PROJECT PLANNING & INTEGRATION – Because the PRH is a DCAE sub-project. Integrate & Deploy; Project management aspect DCAE Deployment plan. Wrap in container. Plan to address how to scale requirements from description. Stateless. (DCAE meeting on Feb 15, 2018)

PNF Plug and Play Projects Impacts

ONAP Project	IMPACT
SDN-C	<ul style="list-style-type: none">• (Step 35) NETWORK ASSIGNMENTS - Assignments for PNF and update AAI.<ul style="list-style-type: none">(1) Pre-load data(2) DHCP used. In TOSCA model specify if DHCP methodology is used. SDN-C knows DHCP will assign. Ent IP@ manager.• (Step 35) SO to SDN-C API for PNF – what API for transport configuration? Need API or API adaptations will be needed for SDNC (no appropriate API for PNF configuration).<ul style="list-style-type: none">• GENERIC RESOURCE API – Message Extensions { 1...6 – VF-module activate (can reused), Assign, Configure, Deactivate }<ul style="list-style-type: none">(1) <i>Assign (Generic Resource API)</i> – Try to reuse Generic Resource API for assign with parametric updates to adapt from VNF usage to PNF. SO queries SDN-C for network assignments. What does it return? Return null. <i>In release 2 we expect PNF IP@ will have already been assigned (and thus the assign query will return null; SO will gracefully accept as valid response)</i>• (Step 37) Service Configuration (Open Point) – How will to send CU IP@ (configuration information) to PNF. When send PNF ID (Correlation ID) send CU IP@. This will be sent via NetConf. Ansible. Chef. Could be dependent on PNF. Eventually need to support multiple protocols.

ONAP Project	IMPACT
DCAE	<ul style="list-style-type: none">• (Step 27 & 31) SUBSCRIBE - Subscribe to new PNF Discovery VES event and publish new PNF Discovery DMaaP event• No Impact

PNF Plug and Play Projects Impacts

ONAP Project	IMPACT
SO	<ul style="list-style-type: none">• Service Instantiation for services on PNFs; implement PNF specific behavior• (New Steps 15-19) <u>SERVICE INSTANTIATION (PART 1)</u> – Alternative steps• (Step 15-17) <u>HOMING/SO & OOF</u> – SO will add S/W to skip this step. In the [FUTURE] PNF homing may be needed. Interaction between SO & OOF• (Step 20) <u>A&AI ENTRY CREATE (Open Point)</u> – “SO will check & create the A&AI entry”. Seshu: I propose to have VID create A&AI entry on step 20 (instead of SO). This needs an A&AI I/F. Reason: this “kludge” incurs technical debt.• (Step 34) <u>SO UPDATE PNF FLOW (Open Point)</u> – PIM notifies SO. SO Subscribe to new PNF Ready DMaaP event. “life long” event (SO gets call from “create instance”) for Beijing use “life long” event. User (or PIM) triggers (a new SO instantiation). (?)(Open Point) New interface for “Update PNF Flow” (Seshu to check if can be done).• (Step 35) <u>GENERIC RESOURCE API</u> –<ul style="list-style-type: none">• <u>ASSIGN</u> – S/W change for SO to receive Generic Resource API queries SDN-C for network assignments. When null return SO will accept and proceed. SO can add code to “skip” the SDN-C assign step (as we expect it to have returned “null” anyway).• (Step 36) <u>ACTIVATE (SO -> SDN-C)</u> - current flow; for Configuration & Assigning of resources. SDNC w/ A&AI w/ update information. If SDN-C can do this step we proceed that way; otherwise SO puts in the DMaaP hook for APP-C. We expect Step 35 & 36 to happen in one “step” in Beijing Release. L1-L3 bring up; control layer after APP-C.

PNF Plug and Play Projects Impacts

ONAP Project	IMPACT
INTEGRATION TEAM	<ul style="list-style-type: none">• SHOWCASING (Open Point) – Integration team details.<ol style="list-style-type: none">(1) CONTENT - Test send registration event. Instantiation Pt1/2. PRH service. SDNC Ansible command. Update A&AI. PNF sends event, receives ansible event.<ol style="list-style-type: none">(2) DEMO - Where will this be demo showcased? What will the demo look like? ONAP “Open Lab”. At AT&T in various locations. Virtual Demo (dial in). ONAP installed in a lab. Demo shown via conference. Could show existing R1 use case upgraded w/ mechanisms of R2. DU Emulator.<ol style="list-style-type: none">(3) Demo Document – Document describing demo (use case group?) https://wiki.onap.org/display/DW/vCPE+Use+Case+Tutorial%3A+Design+and+Deploy+based+on+ONAP+Amsterdam+Release• ACTUAL PNF (Open Point) – Will there be an actual PNF? A physical DU? R1 PNF Emulator. Show case using vCPE use case.• LOGISTICS (Open Point) – Integration logistics.<ol style="list-style-type: none">(1) DEMO ANNOUNCEMENT – “come see this demo” – Integration ONAP Wiki. Video. Schedule ONAP Wiki Events Calendar. Integration project. (SME = x)<ol style="list-style-type: none">(2) COORDINATING – Key points of contact.• AUTHENTICATION (Open Point) – Use Amsterdam Authentication flow (using second vDHCP & vAAA). Have the right IP address (from DHCP). <i>Modify vCPE use case</i> (assumes BNG). Amsterdam flow was useless for PNFs (didn’t do anything). Let’s not do any authentication. Possibly consider an alternative to the vCPE Amsterdam flow? Owner = Integration project. Proposal for Beijing demo not to have Username & Password for Beijing.

FUTURE Post-Beijing

ONAP Project	IMPACT
AAF	<ul style="list-style-type: none">• (Step 23, 24, 25) [FUTURE] AUTHENTICATION (Open Point) – What will the long-term PNF plug and play authentication solution look like? (will not be solved in Beijing Release)
SDN-C	<ul style="list-style-type: none">• GENERIC RESOURCE API – Message Extensions { 1...6 – VF-module activate (can reused), Assign, Configure, Deactivate }<ul style="list-style-type: none">(2) <i>Configure</i> (Generic Resource API) – Try to reuse Generic Resource API for assign with parametric updates to adapt from VNF usage to PNF. Device spun-up; configure the device (for L1-L3). [Not needed for PNF Plug and Play]. <u>NOT IN SCOPE OF BEIJING RELEASE.</u>(3) <i>Deactivate</i> (Generic Resource API) – Try to reuse Generic Resource API for assign with parametric updates to adapt from VNF usage to PNF. [Not needed for PNF Plug and Play]. <u>NOT IN SCOPE OF BEIJING RELEASE.</u>
SO	<ul style="list-style-type: none">• (Step 35) GENERIC RESOURCE API –<ul style="list-style-type: none">• <i>Configure</i> (Generic Resource API) – For PNF configure the device (for L1-L3). [Not needed for PNF Plug and Play]. <u>NOT IN SCOPE OF BEIJING RELEASE.</u>• <i>Deactivate</i> (Generic Resource API) – For PNF PNP. [Not needed for PNF Plug and Play]. <u>NOT IN SCOPE OF BEIJING RELEASE.</u>• (Step 36) ACTIVATE (SO -> SDN-C) - current flow; for Configuration & Assigning of resources. SDNC w/ A&AI w/ update information. SO -> APP-C (FUTURE). VF-Scale out. If SDN-C can do this step we proceed that way; otherwise SO puts in the DMaaP hook for APP-C (?). We expect Step 35 & 36 to happen in one “step” in Beijing Release. L1-L3 bring up; control layer after APP-C.
Modeling, SDC, VNF-SDK	<ul style="list-style-type: none">• [FUTURE] PNF ARTIFACTS DISTRIBUTION (Open Point) – (Step 1-3) (Ansible API for SDN-R send CUIP@). For PNF service design template do we need to add a option to deployment artifact, right now SDC doesn't allow you to add this, so is this needed? How would SDN-C receive the ansible API for PNFs. Beijing Solution: Hardcode the CU IP@ (Data).

Backup Slides Meeting Notes & Email Exchanges



PNF Plug and Play (PnP) Overview (e.g.)

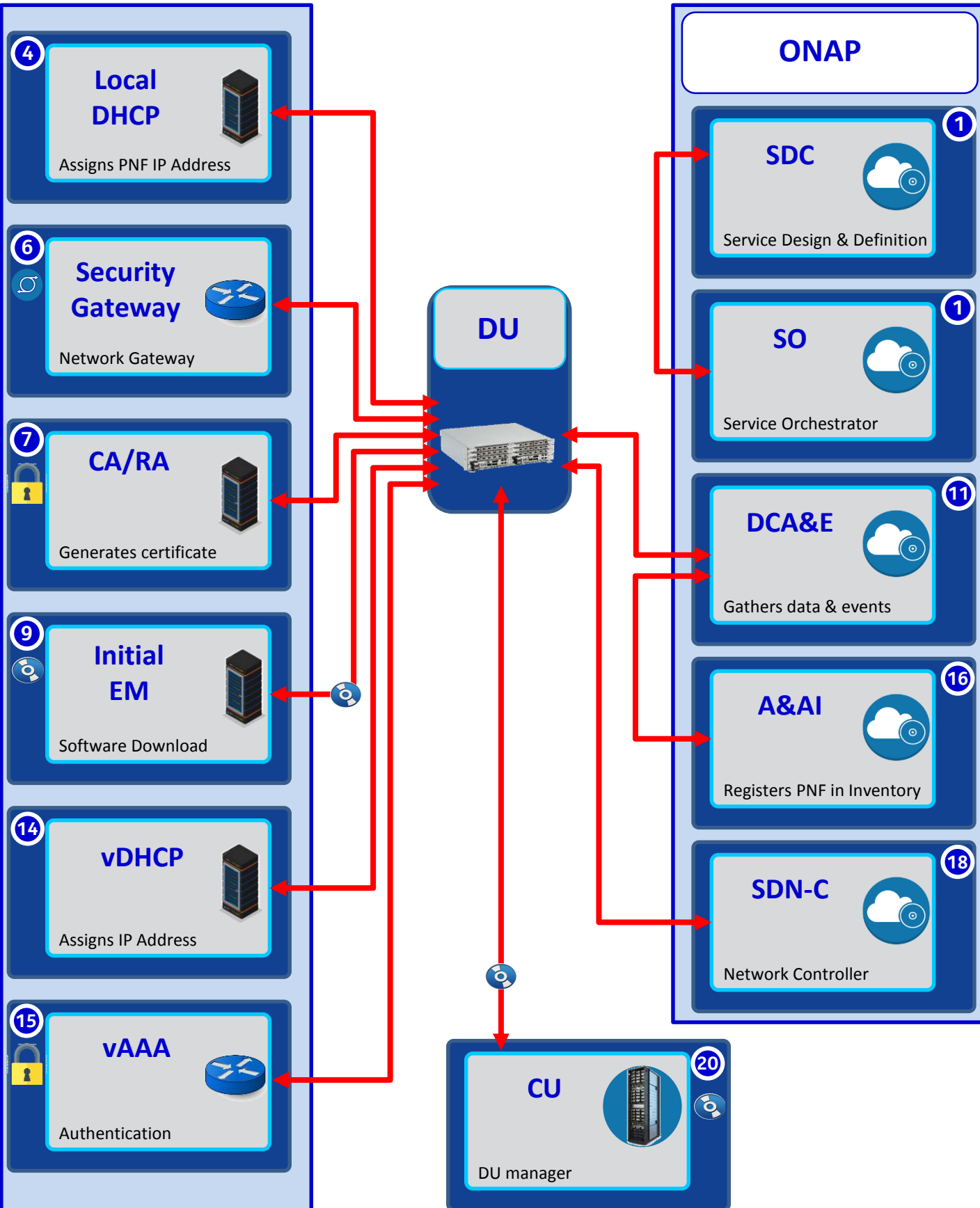

Once instantiating such service that contains a node template of type PNF, the following will be presented.

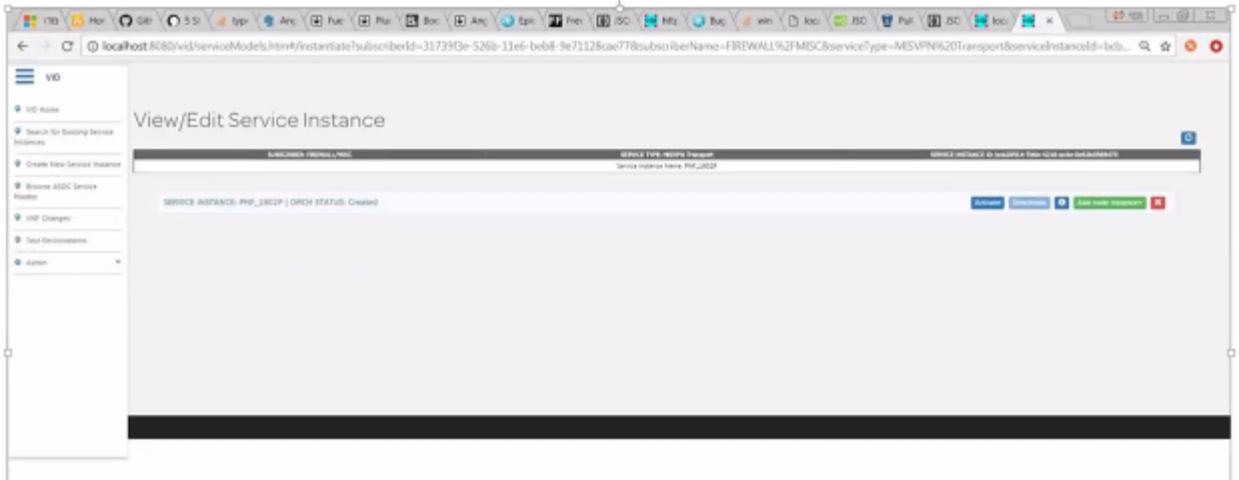

Choosing the right PNF from the "Add node instance" drop down will lead to the following page:

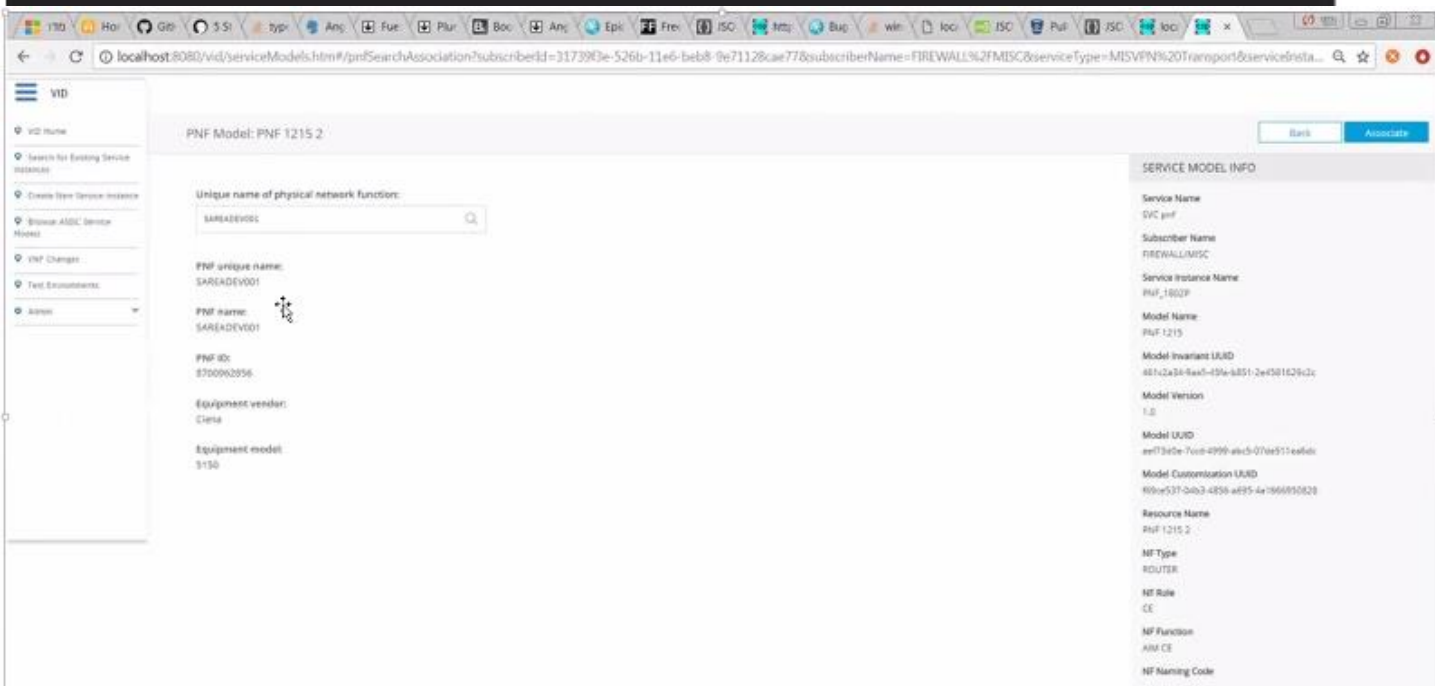
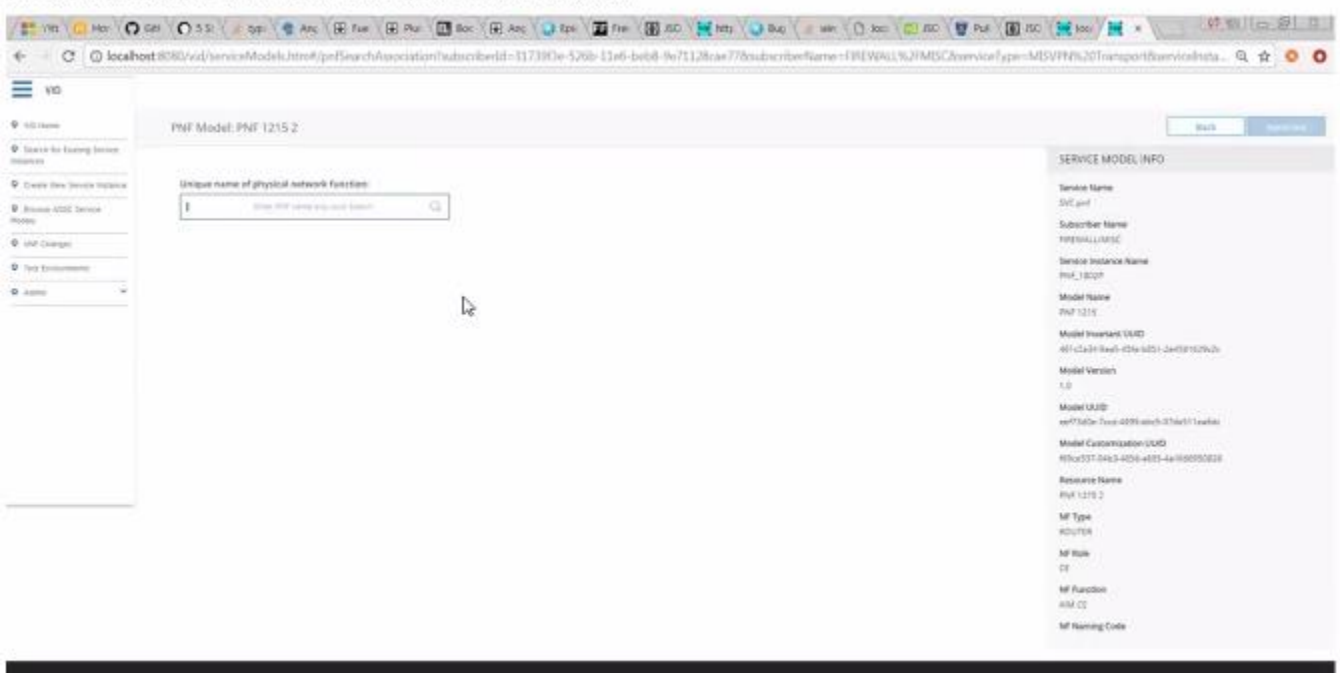

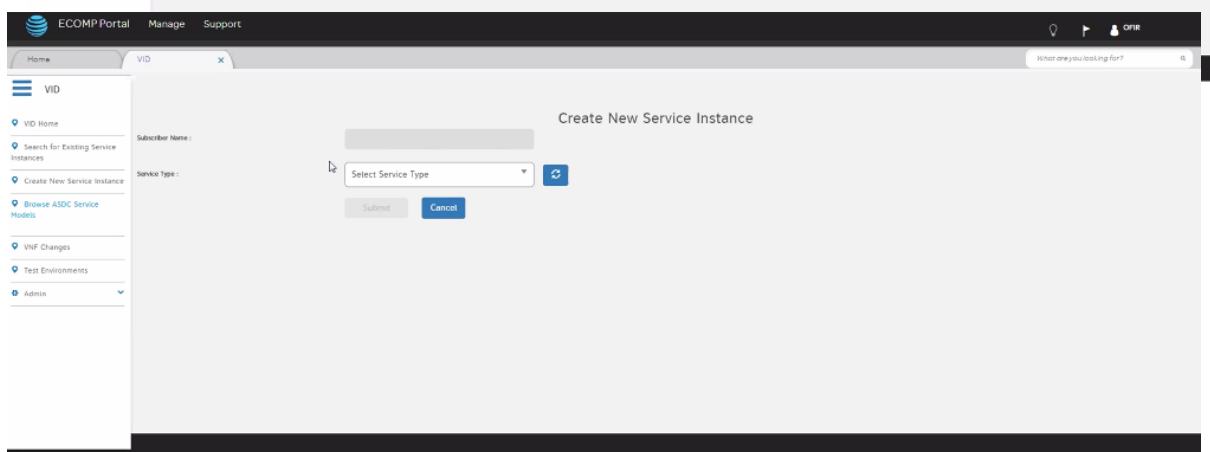
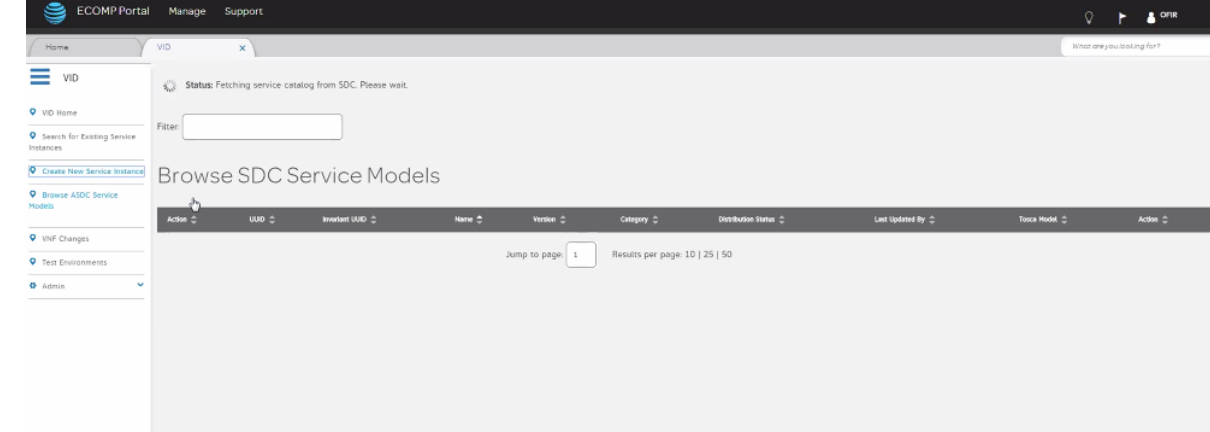

Create Service Instance -- a la carte

Service Name: 06-15-WID-Issue-SERVICE
Service Invariant UUID: 2fa617d0-50b3-4d74-861d-4b39301acd2c
Service Version: 1.0
Service UUID: ae5d24f4-f602-46d0-9a62-ed3f28928b50
Service Description: 06-15-WID-Issue-SERVICE
Service Category: Network L1-3
Service Type:
Service Role:

User Provided Data (* indicates required field)

Instance Name: *	<input type="text" value="Enter data"/>
Subscriber Name: *	<input type="text" value="Select Subscriber Name"/>
Service Type: *	<input type="text" value="Select Service Type"/>
Project:	<input type="text" value="Select Project Name"/>
Owning Entity: *	<input type="text" value="Select Owning Entity"/>
Suppress Rollback on Failure:	<input type="text" value="false"/>

Enter Data and Confirm to Create Service Instance

Cancel to Return to Previous Page.

User Provided Data (* indicates required field)

Instance Name: *	<input type="text" value="MyService"/>
Subscriber Name: *	<input type="text" value="Mobility"/>
Service Type: *	<input type="text" value="Select Service Type"/>
Project:	<input type="text" value="DFW"/>
Owning Entity: *	<input type="text" value="OE1"/>
Suppress Rollback on Failure:	<input type="text" value="false"/>

Enter Data and Confirm to Create Service Instance
 Cancel to Return to Previous Page.
 Data entered will be lost

- OE1
- 0a30
- 0a40
- 0EX
- 0EY
- OpticalTransport
- PacketCore
- Premises
- U-verse/DIRECTV(EntertainmentGroup)
- Wireline

Instance Name: *	<input type="text" value="MyService"/>
Subscriber Name: *	<input type="text" value="Select Subscriber Name"/>
Service Type: *	<input type="text" value="MSO_1E10_ST_PACKET CORE ICORE CORE PACKET1 CORE"/>
Project:	<input type="text" value="JimmyExampleCust-20161102 JimmyExampleCust-20161103"/>
Owning Entity: *	<input type="text" value="DHV1802-TestSub-PWT-102 DHV1802-TestSub-PWT-101"/>
Suppress Rollback on Failure:	<input type="text" value="Mobility"/>

Enter Data and Confirm to Create Service Instance
 Cancel to Return to Previous Page.
 Date entered will be lost

- Mobility
- DHV1802-Subscriber-5
- DHV1802-TestSub-PWT-103
- DHV1802-Subscriber-2
- USP VOICE
- DHV1802-Subscriber-3
- FIREWALL/MISC

Instance Name: *	<input type="text" value="MyService"/>
Subscriber Name: *	<input type="text" value="Mobility"/>
Service Type: *	<input type="text" value="Select Service Type"/>
Project:	<input type="text" value="Select Service Type vMMS vMNS"/>
Owning Entity: *	<input type="text" value="vVoiceMa"/>
Suppress Rollback on Failure:	<input type="text" value="Mobility"/>

Enter Data and Confirm to Create Service Instance
 Cancel to Return to Previous Page.
 Data entered will be lost

- Mobility
- vMOG
- vSCP
- vBNG
- Nimbus

Enter Data and Confirm to Create Service Instance

Cancel to Return to Previous Page. Data entered will be lost

Feb 16, 2018

ATTENDEES – Ben, Gil, Vimal, Oskar, Shekar, Ken Shi, Linda, Marge, Sigmar, Timo P.

Dandrushko, Brian, Dmitriy Andrushko (Mirantis)

AT&T Canopy – preloads A&AI w/ PNFs

But that only works for big PNFs.

Work orders – individual devices are ordered

Canopy is database of physical assets

Can sync up A&AI in advanced

That model doesn't work for consumer.

Because you don't know which instance you will use until it is dispatched

For consumer a technician has many "boxes" PNFs with them.

Pull a "random" box and plug it in.

Don't know until last minute which instance will be used.

It was proposed that (CUTTING OUT) which device to use

Let's have that go to Canopy (CUTTING OUT)

VES event go to canopy, if event repeated outage, wanted event to go DCAE

(CUTTING OUT)

A&AI device to be configured (CUTTING OUT)

Bring your own device so plug in device, go to website (VID-like)

Enter "please activate it"

WORK ORDER/SERVICE ORDER needs to be updated, asset management

Tracking dozen boxes know which box is where (CUTTING OUT)

Assess management tracking systems; service order updated

BSS Systems; for this customer service order; we're using this device.

Could ask technician additionally type in MAC address in VID or

Update VID first. When tech scans box, in addition to update service order (released to ONAP). Have

that scan result in a separate (CUTTING OUT) to first inventory the PNF. Then release the service order

to ONAP.

STEP 28 could create A&AI; objection any random device connecting; Model

Generic device that can work in 3 contexts; Do I need to know purpose.

PNF model#ABC correlationID = model+MACaddress

Reason why we waited, assumed that needed to have the service context first

Wait for service request (on northbound side)

Device's purpose & context could change over time

Separate as commodity and device [x]

How do we prevent blowing out A&AI (failures, misconfiguration

STORMS of event in Step 26.

Don't want to update A&AI until service I know PNF will serve.

CHURN in A&AI (from many Step 26s)

Distinction between Consumer and Infrastructure (know PNF in advance)

Possible RACE CONDITION for consumer case

For RACE CONDITIONS – if get event ignore it if unknown

Service request/work order update it with instance information

When that service/work order is trigger for ONAP

Feb 19, 2018

ATTENDEES – Ben, Yoav, Oskar, Marge, Sigmar, Damian

NOTES-

- (1) **HOW WILL PNF AUTHENTICATION IN THE FUTURE LOOK LIKE?** TR317 authentication. AAA server exchange (authenticating the DHCP request). TLS2.0 w/ certificate. Post of event to PRH. – Added security to access ONAP. Because this opens the question of *how does the PNF actually get the username/password*. Hard Code? (Put into Initial EM)? AAF project could be used for external communications. DSLAM operators (in your home DSL) port on the other end connects to DSLAM. How does it know to trust? DSLAM adds an option on DHCP request it gets “this came on port :[x]” in the network added profile info; when request arrives goes to AAA server & verifies. [FUTURE] Initial EM = VNF. Gets credentials from ONAP. BNG (broadband network gateway) “router”. Proxy Un/Pass get to Proxy. Draft (standard) for zero-touch “learning” of devices. How do we know it is good?
 - (2) **Where is Username/Password located** – in DHCP server *username & Password (for PNF to access ONAP)* .
 - (3) **Will AAF Project be involved?** – *Will AAF in the future be involved w/ PNF security solution.*
 - (4) **LINKS:** <https://tools.ietf.org/html/draft-ietf-netconf-zero-touch-19>
<https://wiki.onap.org/display/DW/vCPE+Use+Case+Tutorial%3A+Design+and+Deploy+based+on+ONAP+Amsterdam+Release>
- (1) Project Technical Lead (PTL)