

# 5G Service Modeling & 5G Service Creation



- R8 Honolulu Use Cases



# 5G Basics & 5G RAN



# 3GPP Release 15, IMT-2020 = 5G



## eMBB (enhanced Mobile Broadband)



**Media Anywhere**  
**Broadband Experience**  
**Everywhere Anytime**  
Virtual and Augmented Reality

Remote Surgery  
and Examination



Factory Automation  
**Remote Device Control**



Smart Automated  
Vehicle Control



Smart  
Infrastructure  
Smart City



**Internet of Things (IoT)**  
Geographically spread devices

**URLLC (Ultra Reliable Low Latency Communications)**

**mMTC (massive Machine Type Communications)**



**Smart**



**Connected**



**Collaborate**



**Access**



**Interactive**



**Aware**

# 5G RAN Wireless Network

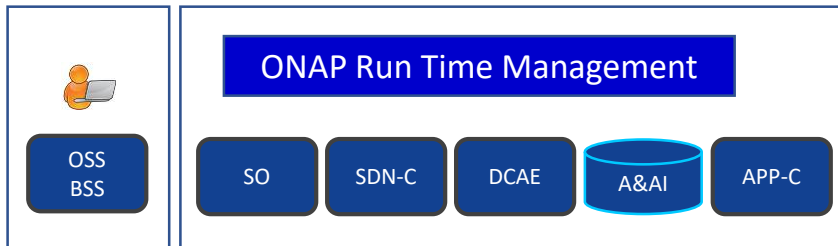

SO – Service Orchestrator  
 SDN-C – Service Design Network Controller  
 DCA&E – Data Collection Analytics & Events  
 A&AI – Available & Active Inventory  
 APP-C – Application Control

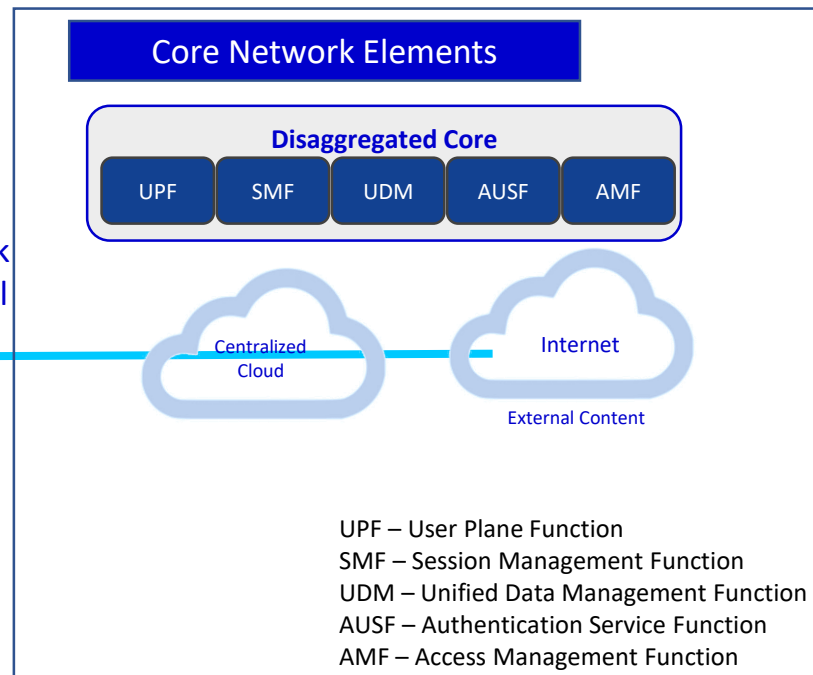
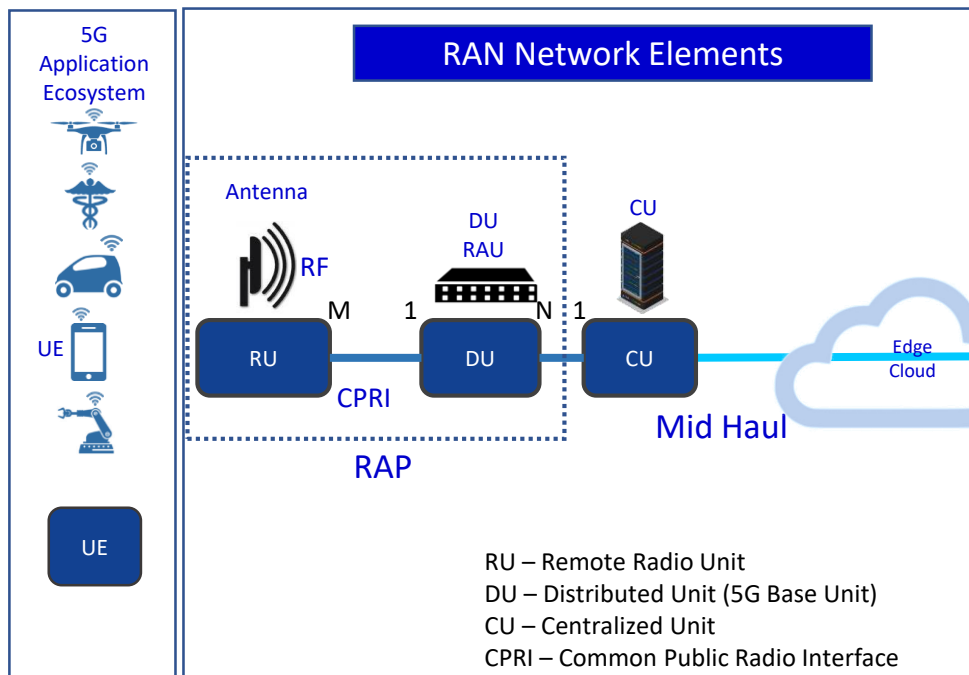

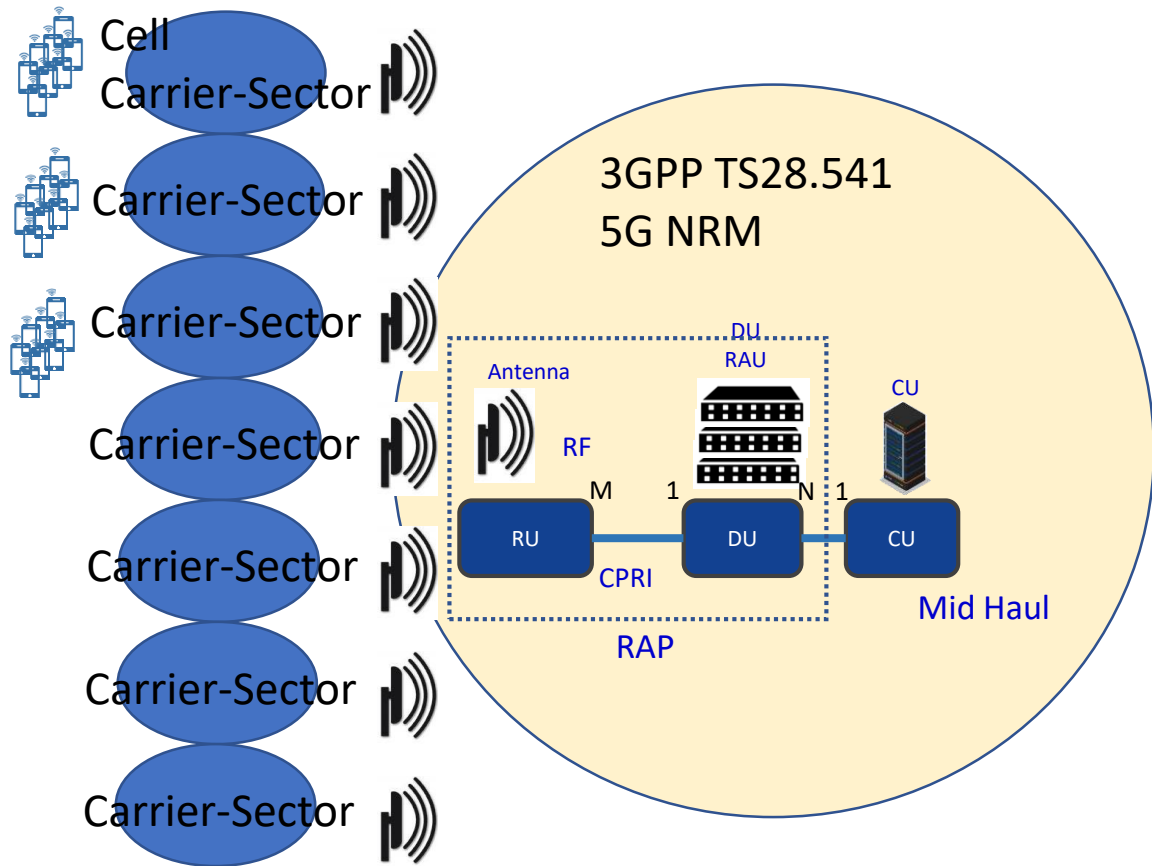



# 5G Service Modeling & 5G Service Creation

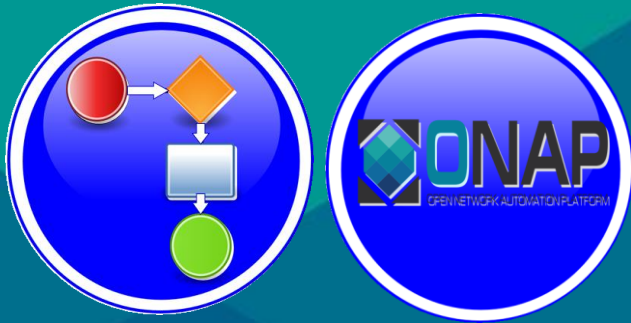

Benjamin Cheung, PhD

# R7: Modeling a 5G Service

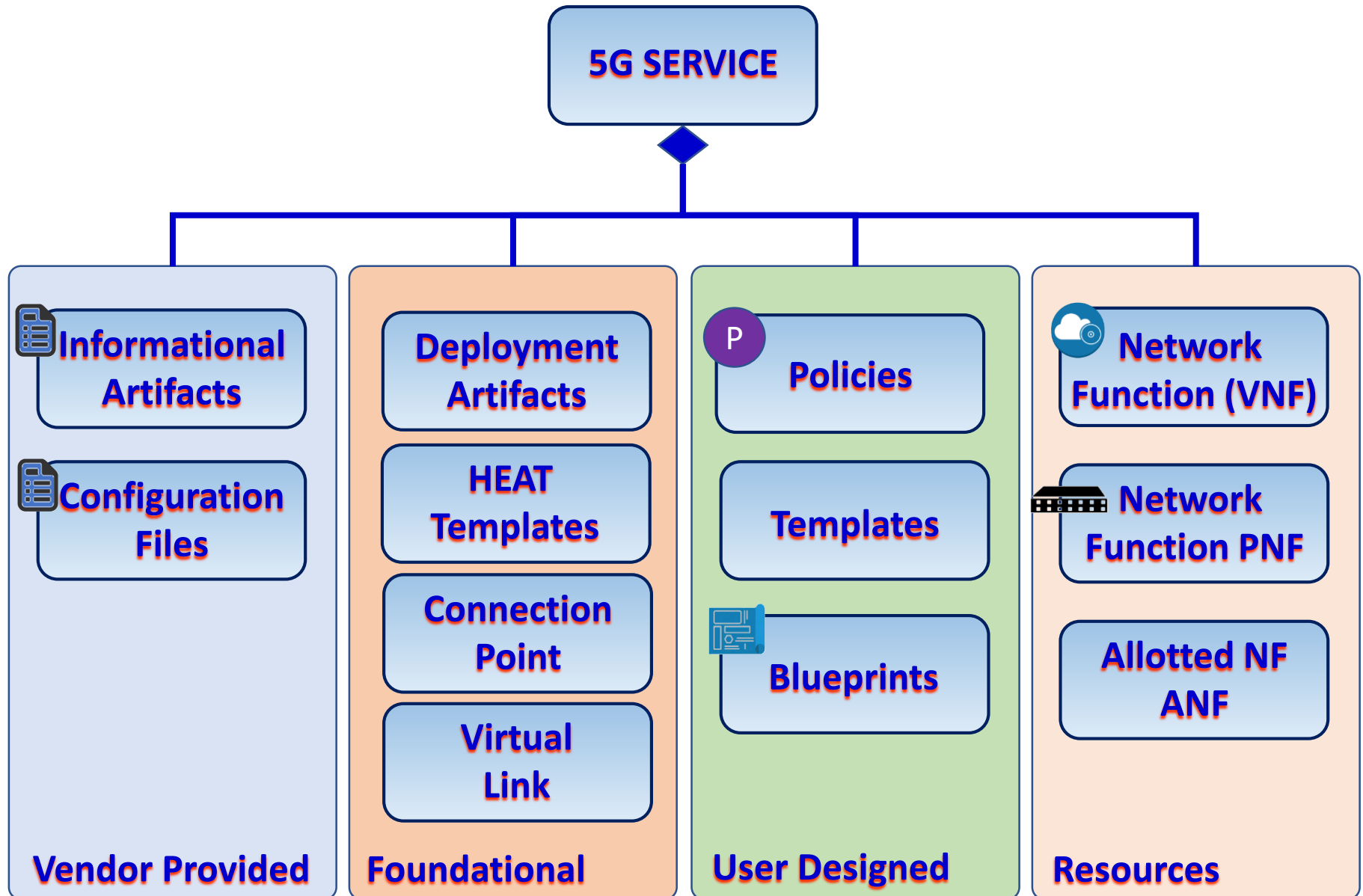

# R8: 5G Service Modeling



<https://wiki.onap.org/display/DW/Honolulu+release+-+functional+requirements+proposed+list>

**EXECUTIVE SUMMARY** - This requirement introduces platform information model enhancements to document new ISOMII experimental classes from 3GPP TS28.541, the 5G Network Resource Model (NRM).

**BUSINESS IMPACT** - The requirement, is a critical because it will serve to lay the ground-work for actually "turning on" a real 5G DU (PNF) that might be installed by a Vendor.

**BUSINESS MARKETS** - This project applies to any domain (wireless, transport, optical, and wireline) that ONAP may manage.

**FUNDING/FINANCIAL IMPACTS** - Without the groundwork laid down for information model management of a 5G Service, operators will not be able to "turn on" a real live 5G network using "live" PNF resources. No Network. No Business. High OPEX impact.

**ORGANIZATION MGMT, SALES STRATEGIES** - There is no additional organizational management or sales strategies for this use case outside of a service providers "normal" ONAP deployment and its attendant organizational resources from a service provider.



# R4: 5G Base Station (gNodeB)



## RAN Network Elements

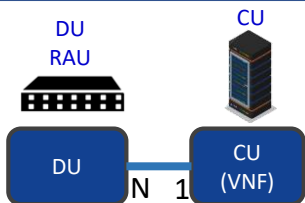

## Core Network Elements

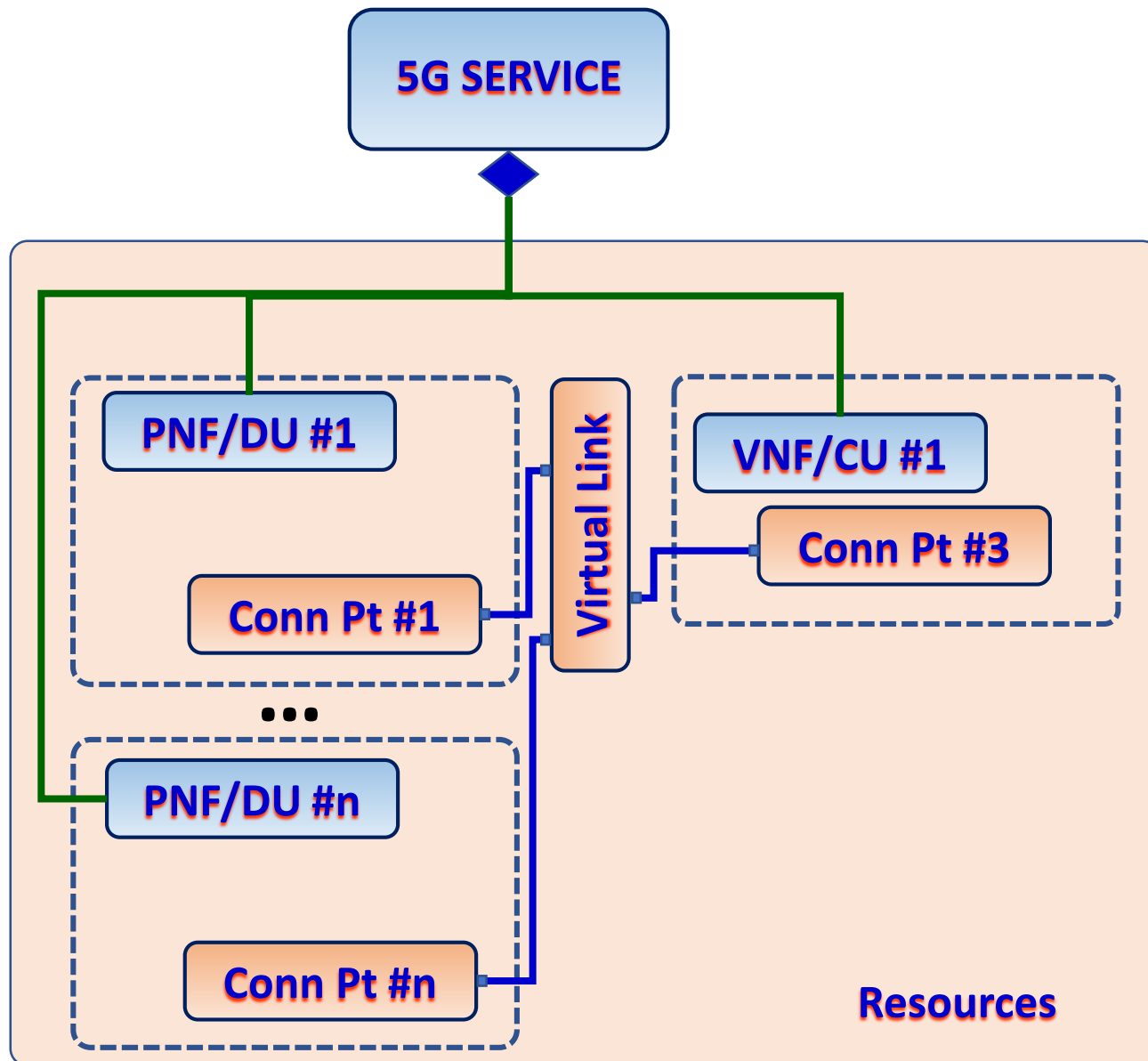

**3GPP TS28.622  
Generic NRM**

**3GPP TS28.620  
FNIM, UIM**

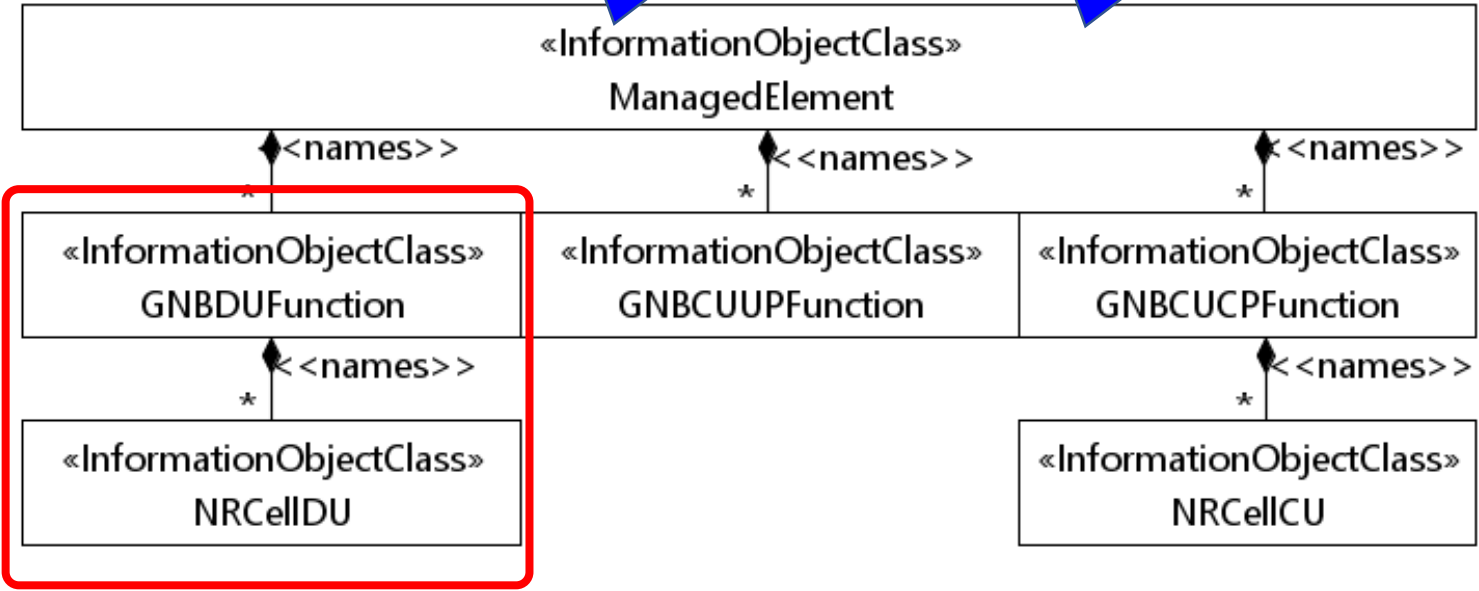

\* Federated Network Information Model (FNIM) , Umbrella Information Model (UIM)

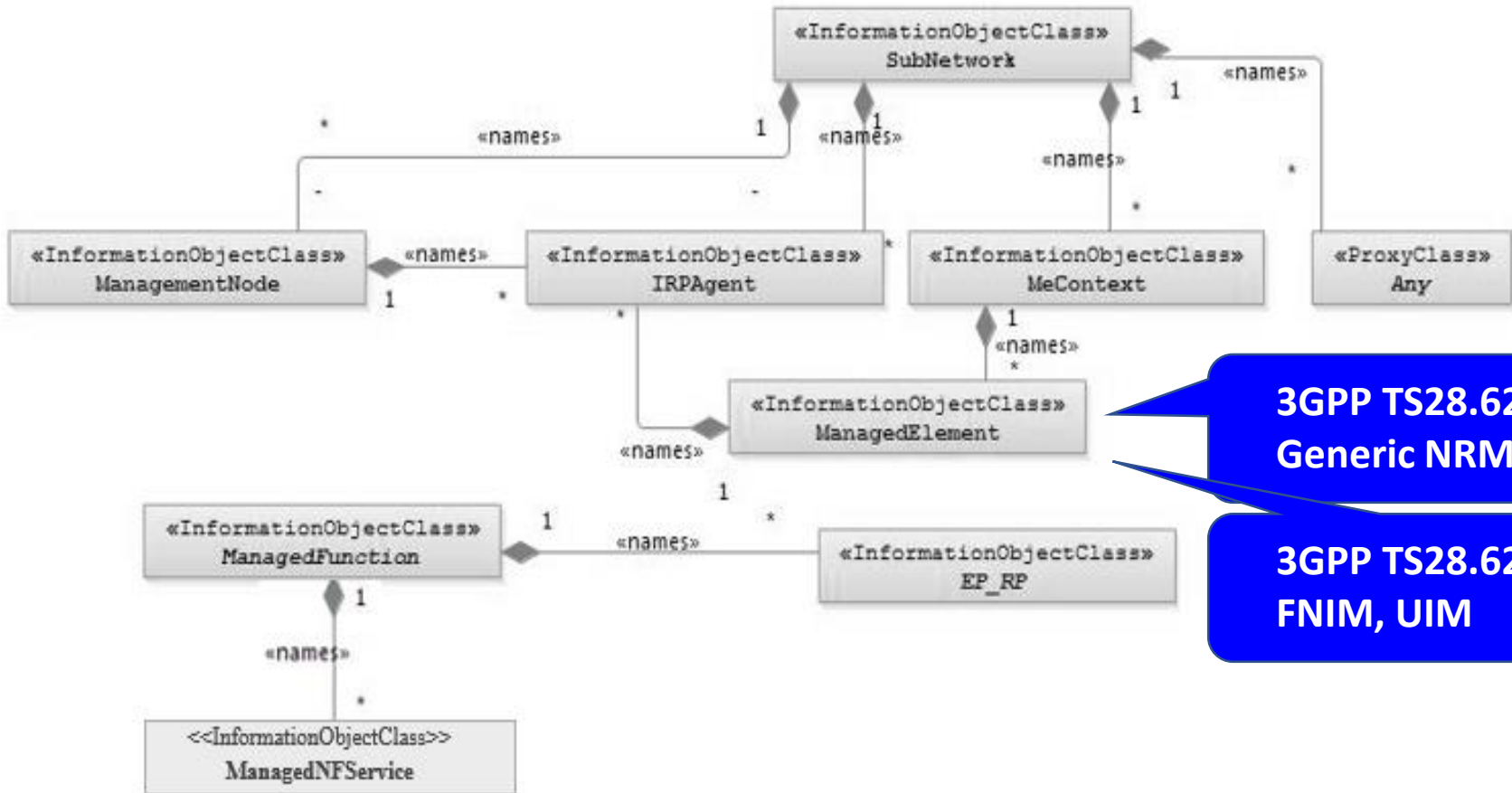

**3GPP TS28.622  
Generic NRM**

**3GPP TS28.620  
FNIM, UIM**

# 3GPP DU Models from TS28.541, 620, 622

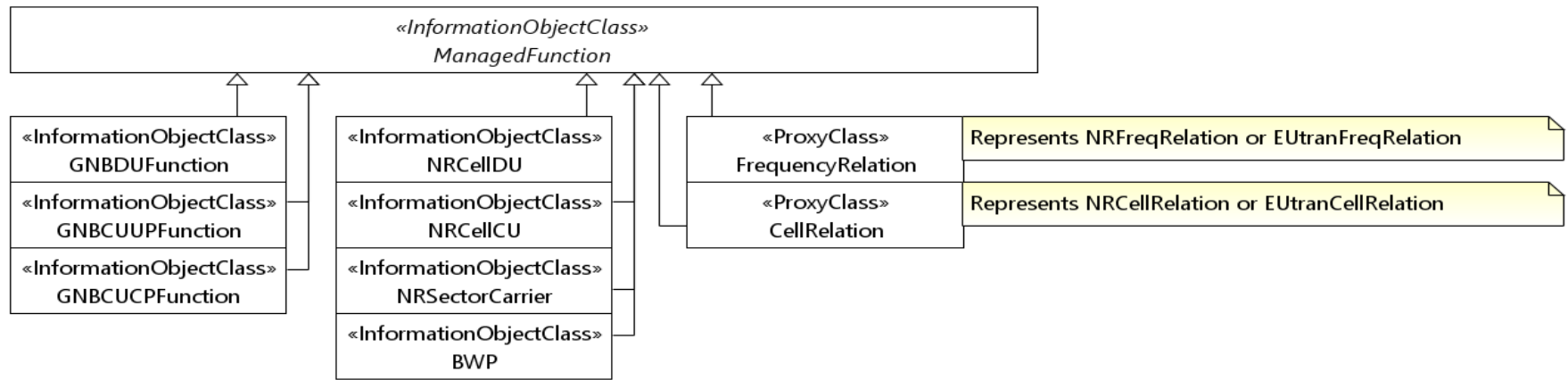
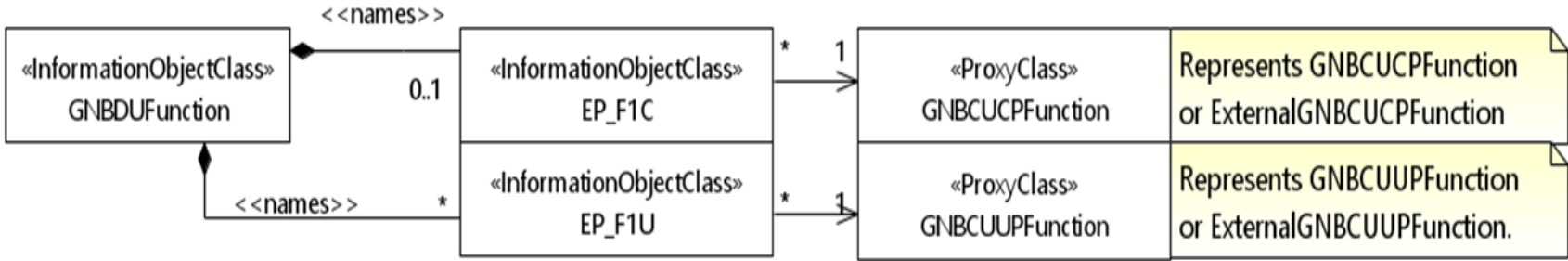
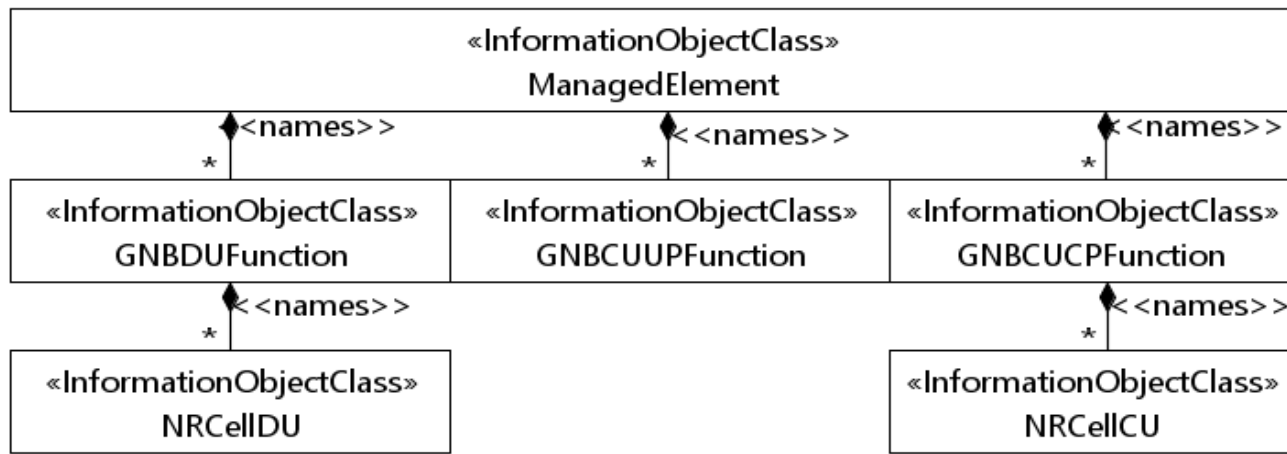

# 3GPP TS28.541 Model (Transport)

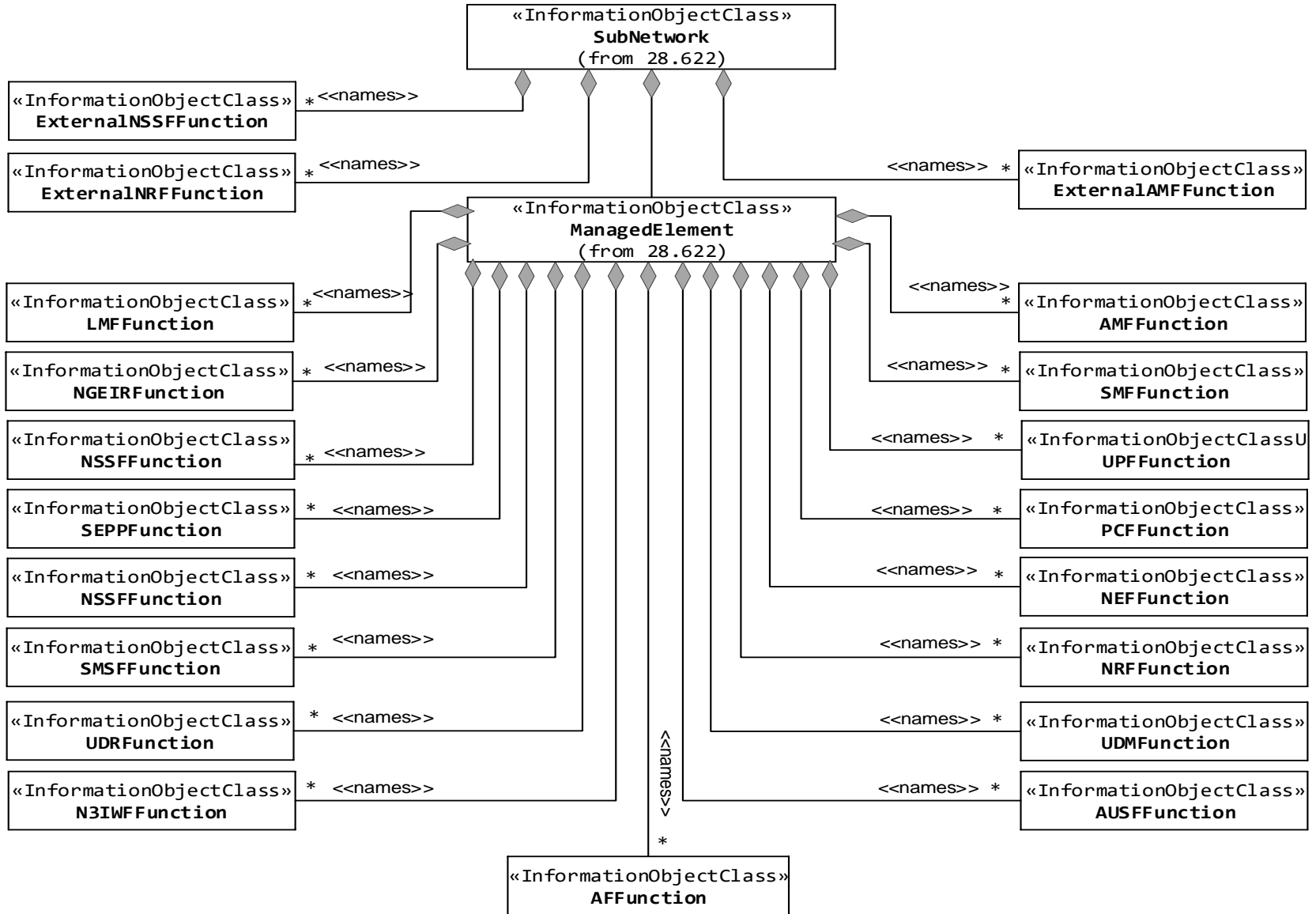

# 3GPP TS28.541 Model (Transport)

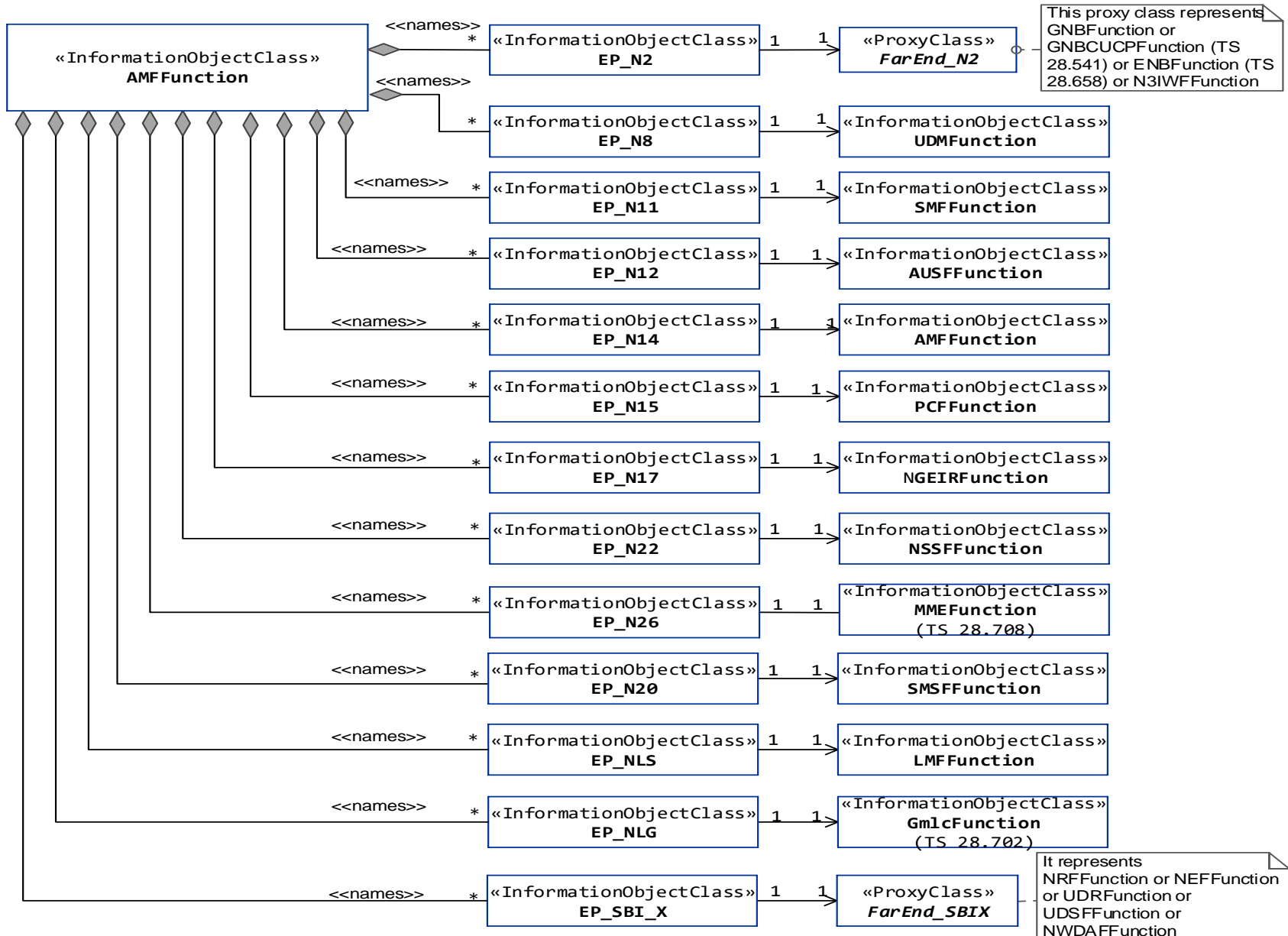

# PNF Descriptor Model

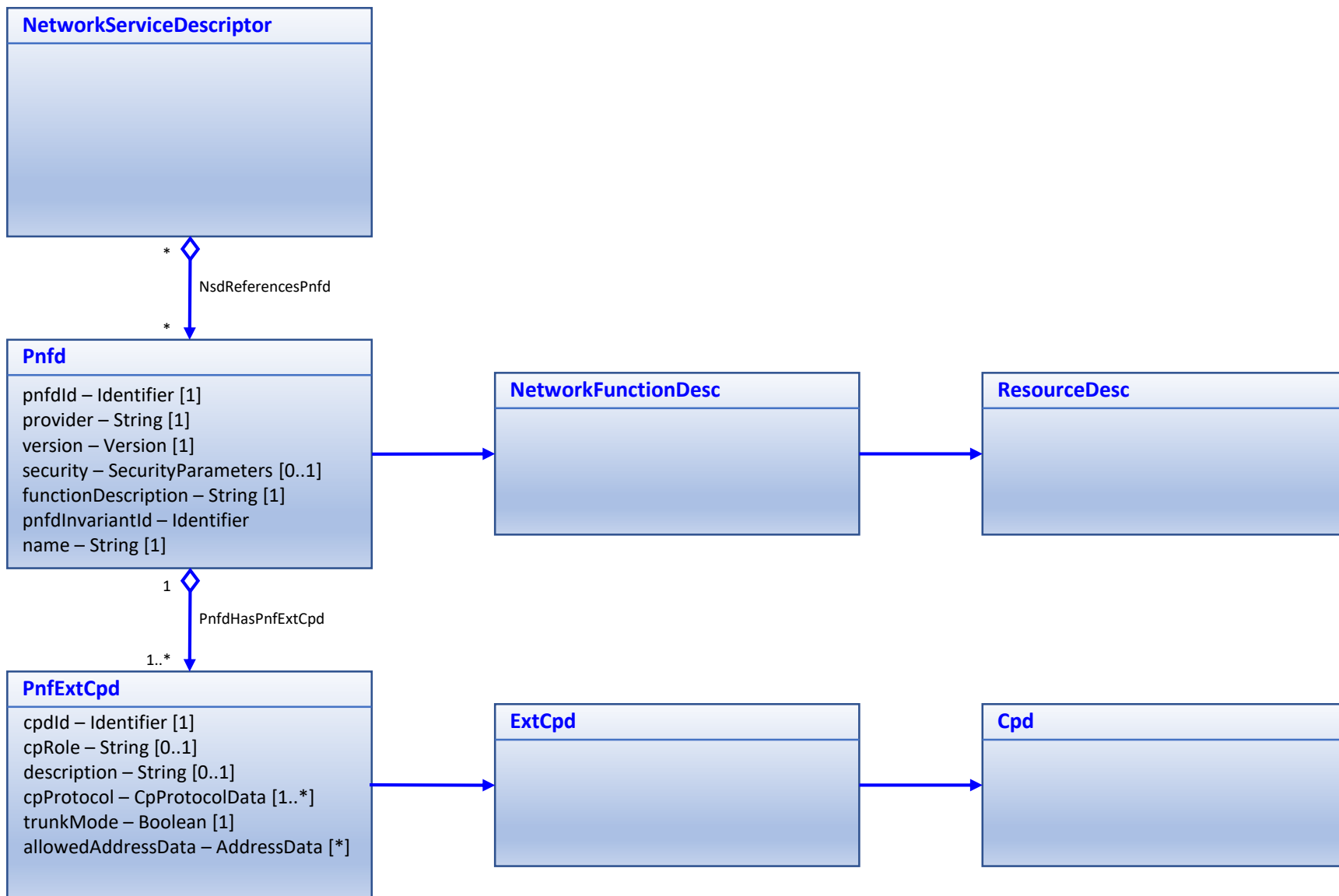





# PNF A&AI Model

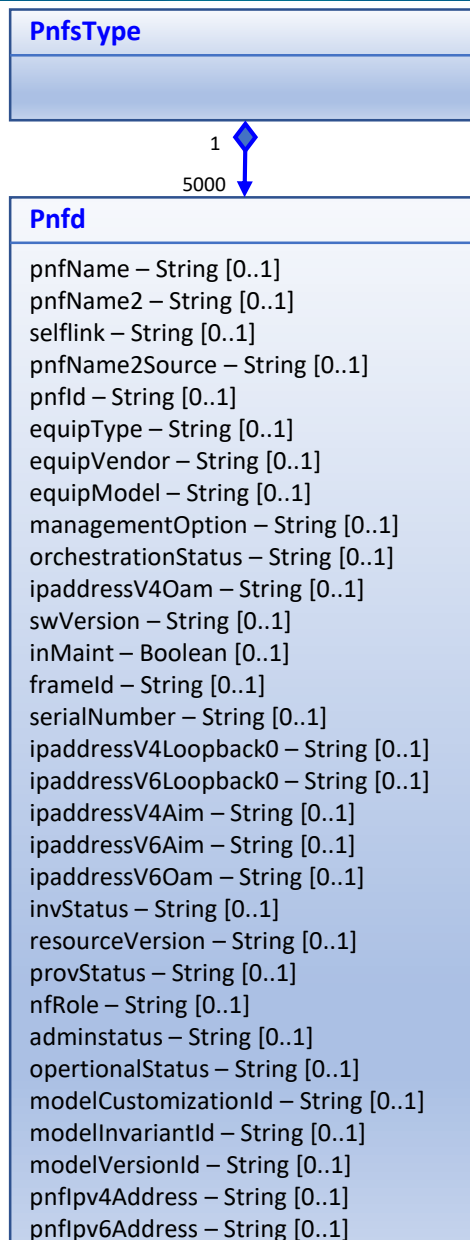

<https://wiki.onap.org/display/DW/Example%3A+PNF+in+AAI>

# Sources



**ONAP**  
OPEN NETWORK AUTOMATION PLATFORM

- A&AI Schema
- SDC AID
- ONAP Platform Information Model
- Complex Object Place object

ORAN WGx

3GPP TS28.501

3GPP Inventory

3GPP TS32.106

ITUT X.731 Op/Admin

3GPP Operational

## Civic Address/GeoLoc

- TMF GB922 Location (Place)
- RFC 6225 Geo Location
- ETSI SOL 001 Civic Address

## 5G NRM

- 3GPP TS28.620 FNIM UIM
- 3GPP TS28.540 5G NRM
- 3GPP TS28.622 Generic NRM
- 3GPP TS28.541 5G NRM

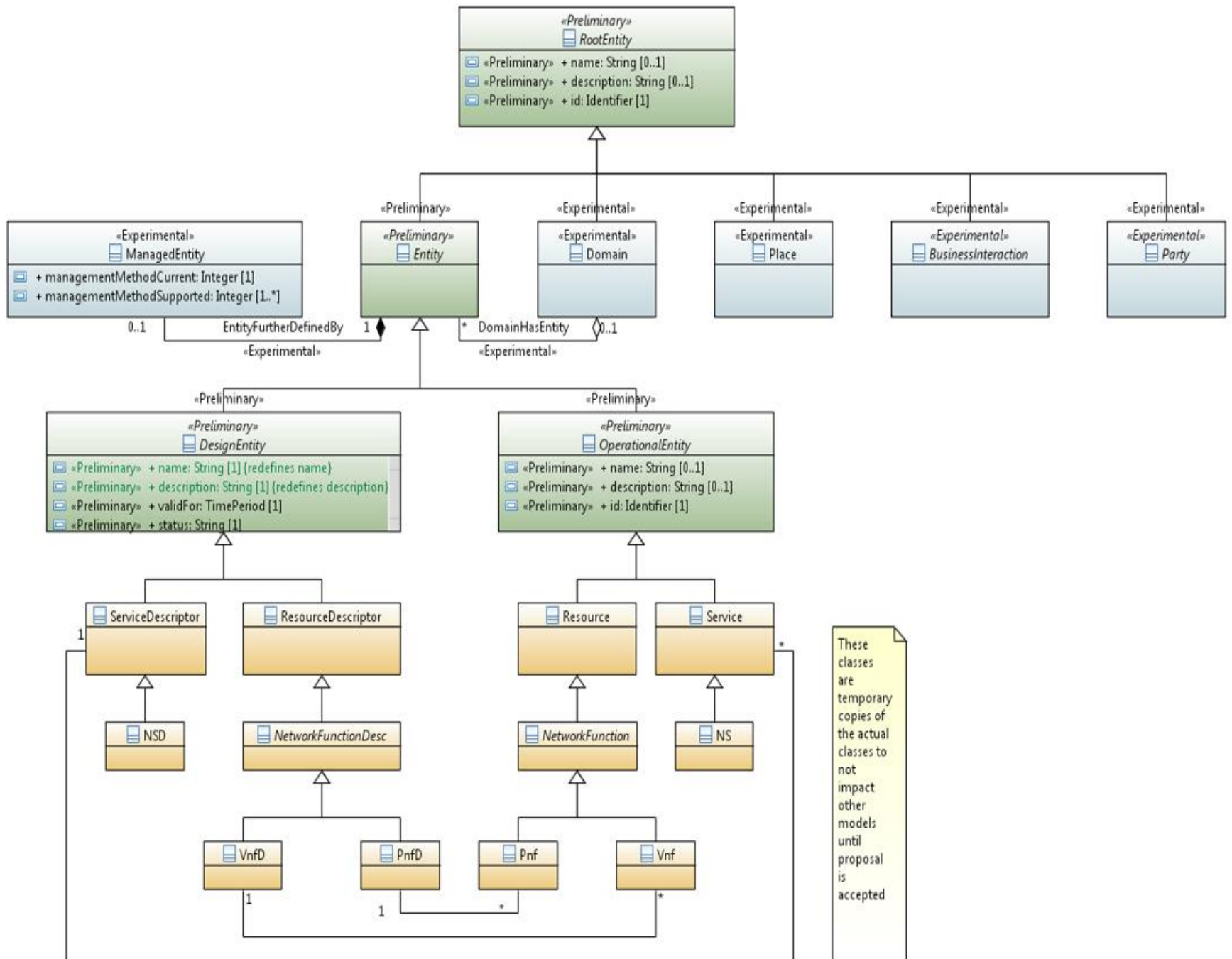

These classes are temporary copies of the actual classes to not impact other models until proposal is accepted

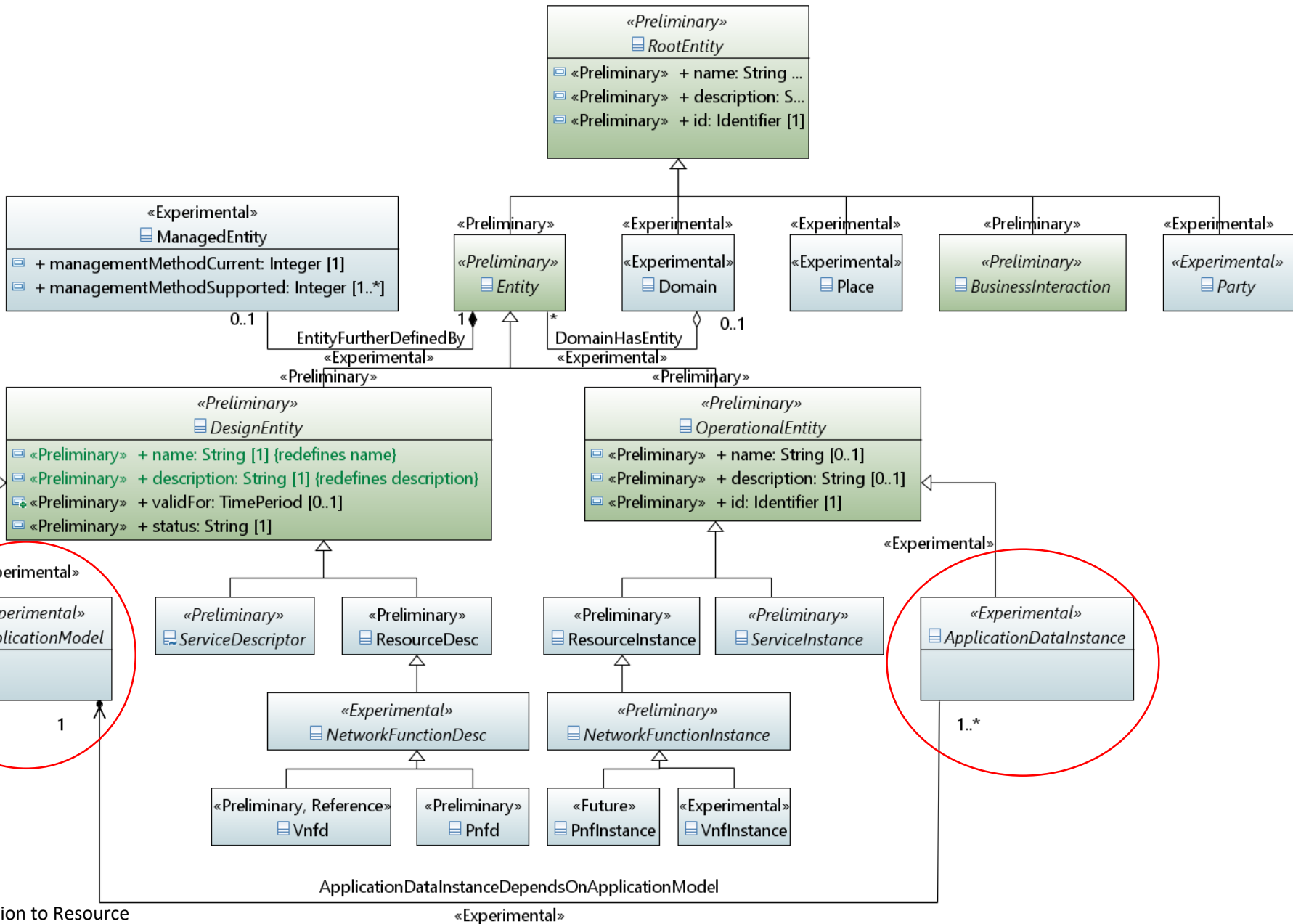

Association to Resource  
 Type of artifact (Yang/Ansible)  
 Connection to Resource Desc  
 Need to Query for Model

# “Place” object in Platform Information Model

ATTRIBUTE	DESCRIPTION	EXAMPLE	TYPE	NOTES
<b>physical-location-id</b>	Unique identifier for physical location, e.g., CLLI (Location ID)	cli Code	String	
<b>data-center-code</b>	Data center code which can be an alternate way to identify a complex	example-data-center-code-val-6667	String	(Data Center centric - may need adaptation for PNF)
<b>complex-name</b>	Gamma complex name for LCP instance.	cli2	String	(ibid)
<b>identity-url</b>	URL of the keystone identity service	example-identity-url-val-28399	String	(ibid)
<b>resource-version</b>	Used for optimistic concurrency. Must be empty on create, valid on update and delete.		String	
<b>physical-location-type</b>	Type, e.g., central office, data center.	example-physical-location-type-val-28399	String	
<b>street address</b>	A string describing the street address of the place.	example-street1-val-28399	Map	Tag Value Array (Name/Value) = (1) "Street value #1=String" ; (2)"Street value #2=String"
<b>city</b>	The name of the metropolitan area, city, township, borough, district, or ward. The Map has with further specific city sub-divisions such as: division, borough, district, ward, chou, neighborhood, block, street group	example-city-val-28399	Map	Map of City (City, Township, Parish) City Division (Borough, District, Ward, Chou) Neighborhood (Block, Street groups)
<b>state</b>	The name of the state, province	example-state-val-28399	String	
<b>postal-code</b>	The string for the postal code or zip code	example-postal-code-val-28399	String	
<b>country</b>	The name of the country	example-country-val-28399	String	
<b>region</b>	The name of the region	example-region-val-28399	String	
<b>additional qualifiers</b>	These are additional descriptive qualifiers (general string) that may be concatenated information representing the structure qualifiers. This is a map, a tag value array of pre-defined qualifier fields including: unit, floor, room, desk	Tag Value Array	Map	
<b>latitude</b>	Latitude in binary geodetic form. A 34-bit fixed-point value consisting of 9 bits of integer and 25 bits of fraction. From RFC6225 (Optional)	example-latitude-val-28399	String	
<b>longitude</b>	Longitude in binary geodetic form. A 34-bit fixed-point value consisting of 9 bits of integer and 25 bits of fraction. From RFC6225 (Optional)	example-longitude-val-28399	String	
<b>elevation</b>	A 30-bit value defined by the Altitude Type field. From RFC6225 (Optional)	example-elevation-val-28399	String	
<b>location-name</b>	the location name (CANDIDATE)		String	
<b>lata</b>	Local Access Transport Area (1920s) (CANDIDATE)	example-lata-val-28399	String	
<b>ctag-pools</b>	CE VLAN IDs		Array	#/definitions/ctag-pool
<b>relationship-list</b>			Object	#/definitions/relationship
<b>Latitude Uncertainty</b>	(Candidates from RFC6225)	When the Ver field = 1, this field represents latitude uncertainty. Uncertainty = $2^{(21-x)}$ . $x = 21 - \text{ceil}(\log_2(\text{uncertainty}))$	String	
<b>Longitude Uncertainty</b>	(Candidates from RFC6225)	When the Ver field = 1, this field represents longitude uncertainty. Uncertainty = $2^{(21-x)}$ . $x = 21 - \text{ceil}(\log_2(\text{uncertainty}))$	String	
<b>Altitude Uncertainty</b>	(Candidates from RFC6225)	When the Ver field = 1, this field represents altitude uncertainty.	String	
<b>Altitude Type</b>	(Candidates from RFC6225)	(1) Altitude in Meters, (2) Altitude in Floors.	String	
<b>Altitude Resolution</b>	(Candidates from RFC6225)	value encodes the number of high-order altitude bits that should be considered valid	String	
<b>Map Datum</b>	(Candidates from RFC6225)	The Map Datum used for the coordinates given in this option: WGS84, NAD83 + NAVD88, NAD83 + MLLW.	String	
<b>Geographic Geometry</b>	TMForum GB922	Modeling sub-team has considered and discussed inclusion of (surfaces, multi-points, and shapes) and concluded that for now, there are immediate use cases that would need this.	Object	

# Enhance Platform Information Model



- 3GPP TS28.540 5G NRM
- 3GPP TS28.541 5G NRM
- 3GPP TS28.620 FNIM UIM
- TS28.622 Generic NRM

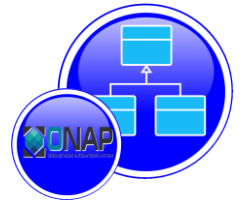

**Platform Information Model ++**



**5G NRM  
Generic NRM**

**DESIGN TIME**

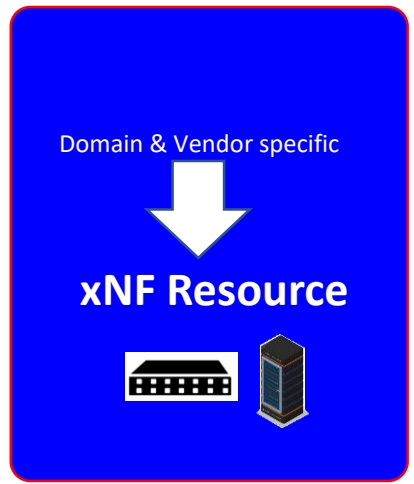

**RUN TIME**

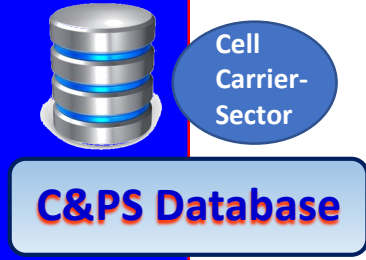



# Generic Application Model

- 3GPP TS28.540 5G NRM
- 3GPP TS28.541 5G NRM
- 3GPP TS28.620 FNIM UIM
- TS28.622 Generic NRM

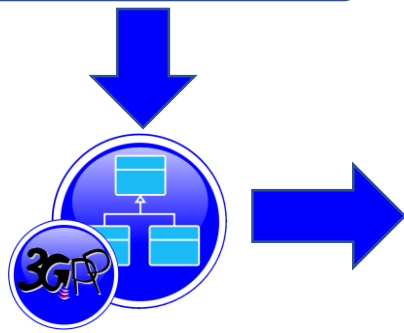

5G NRM  
Generic NRM



Optical ISOMII

**DESIGN TIME** 



**Application Model**

+ Domain & Vendor specific

**xNF Resource**

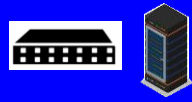



**RUN TIME** 

**SDN-C (etc)**



PNF#106



**C&PS Database**

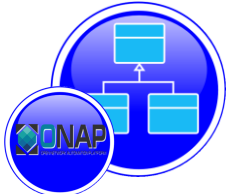

**Platform Information Model**

# Generic Application Model / Hybrid



- 3GPP TS28.540 5G NRM
- 3GPP TS28.541 5G NRM
- 3GPP TS28.620 FNIM UIM
- TS28.622 Generic NRM

Define new artifact type, Design time & Run time  
 Uses that type to retrieve info from 5G NRM artifact  
 Framework is there, minor impact to code.  
 M#1 SDC (onboarding) CBA read yang model from onboarding package  
 M#2 CDS (manually load NRM into CBA)

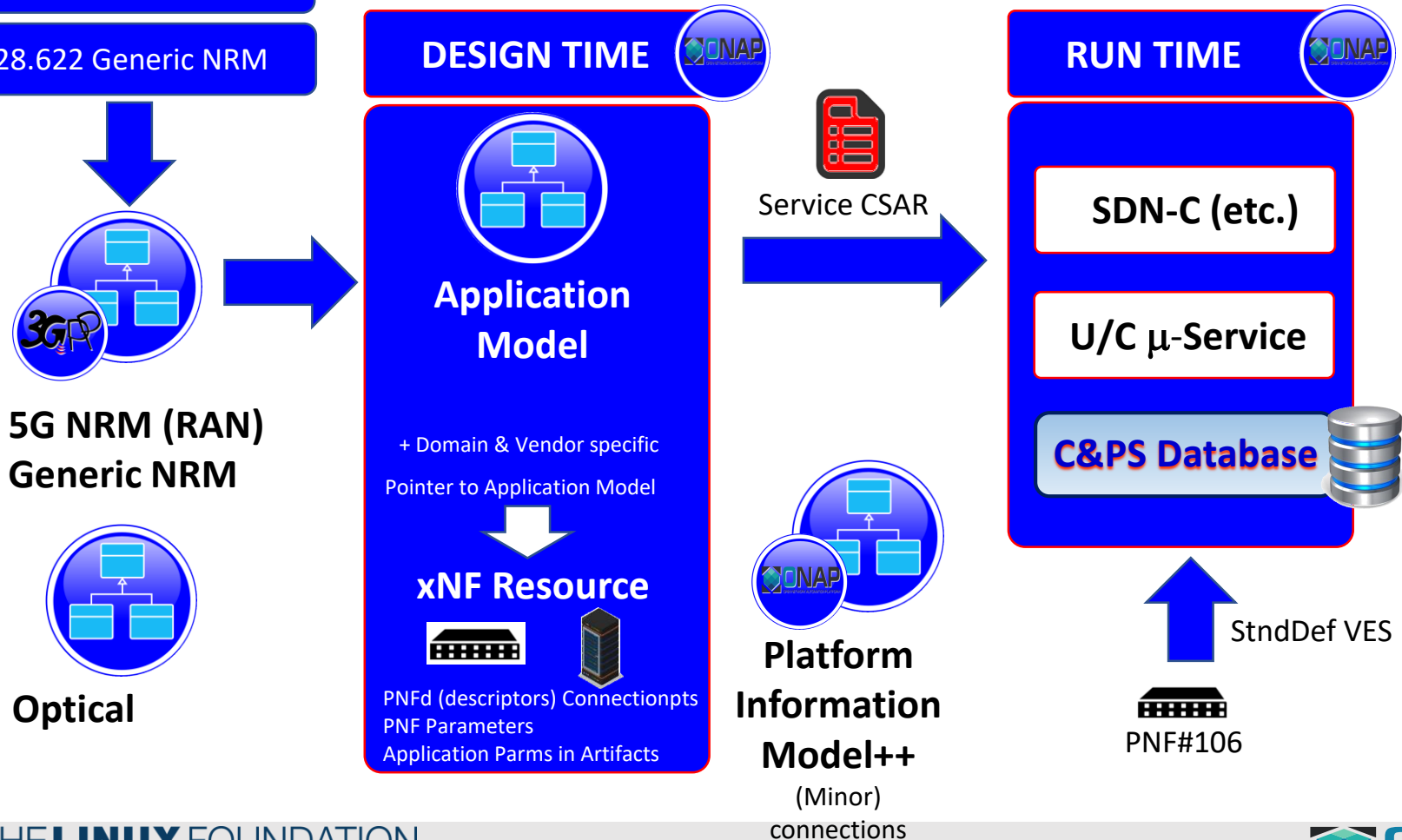



# Generic Application Model / Hybrid – R7



 **NRM . (Yang/Ansible) Artifact**  
 Vendor Onboarded CSAR

- ACTIONS: SDC team – S/W change support **new nonMANO artifact type**
- ACTION: Jacqueline mapping from onboarded NRM to the C&PS Record (modeling Subcommittee). Gen. Application Modeling defined.
- ACTION: new nonMANO artifact types (defined in Modeling Subcommittee)
- ACTION: C&PS team to describe solution
- ACTION: VNF-SDK to validate
- ACTION: VNF-REQTS

Network Slice (Class)  
 serviceProfileList (Attribute)  
 networkSlideSubnetRef

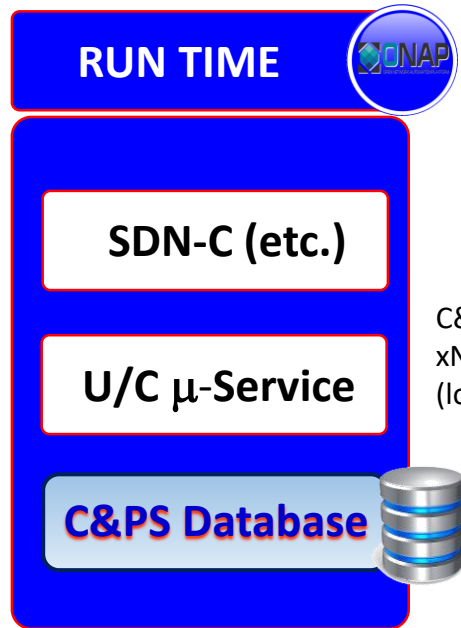
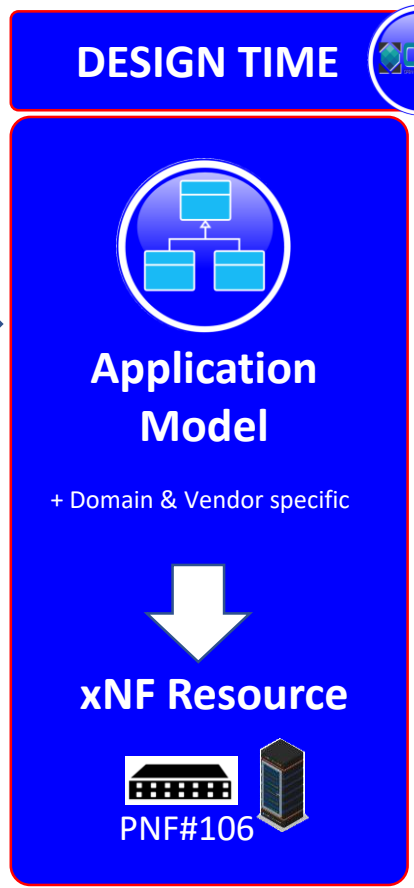

C&PS Record  
 xNF instance  
 (looks at) NRM arti

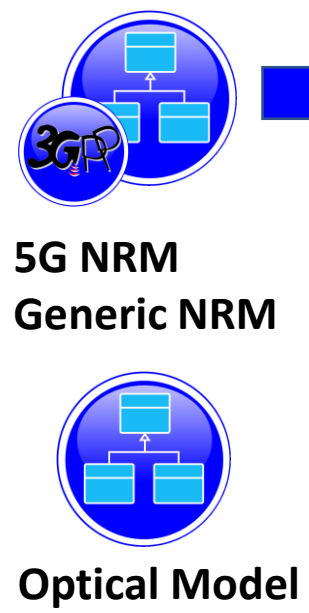
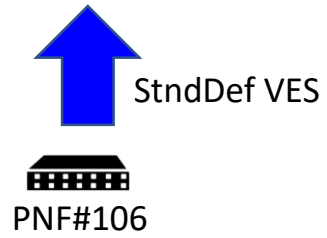

n RT  
 model w/ svc descriptor

TION



# Generic Application Model / Hybrid – R7

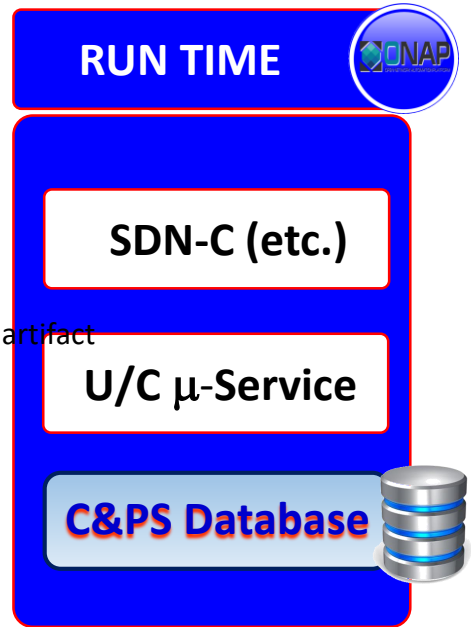

C&PS Record  
xNF instance  
(looks at) NRM artifact

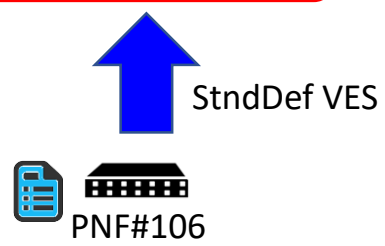

## Service Instantiation

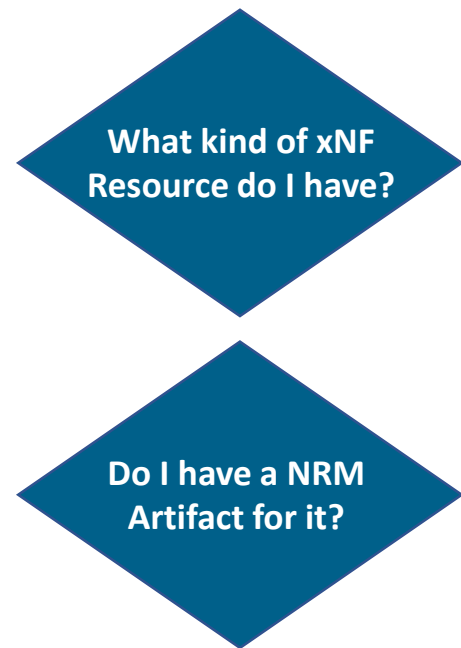

## C&PS Data R/W

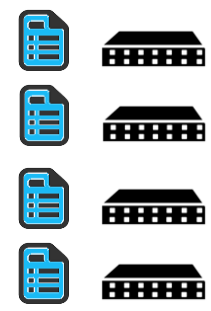
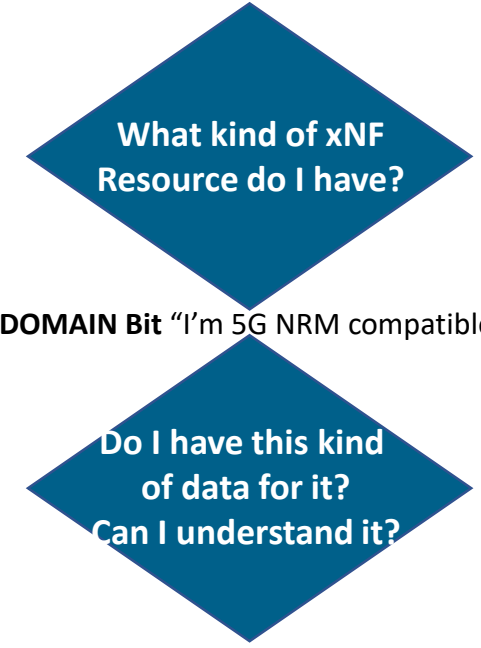

M-S interested in particular kinds of xNFs  
Kind of data in xNF  
Can I identify a model associated w/ the xNF That the mS process.  
How to tag models that are incorporated useful in a catalog to make a decision point to decide if a model is useful to it.  
How to automatically set the Domain Bit/Flag  
\* Meaningful classification – defining a classification of the model & filling it. / Meta-Model Cladistic Topology Model (Meta-Categorization)  
\* Model & resource descriptor link.

# Registry Service



## RUN TIME

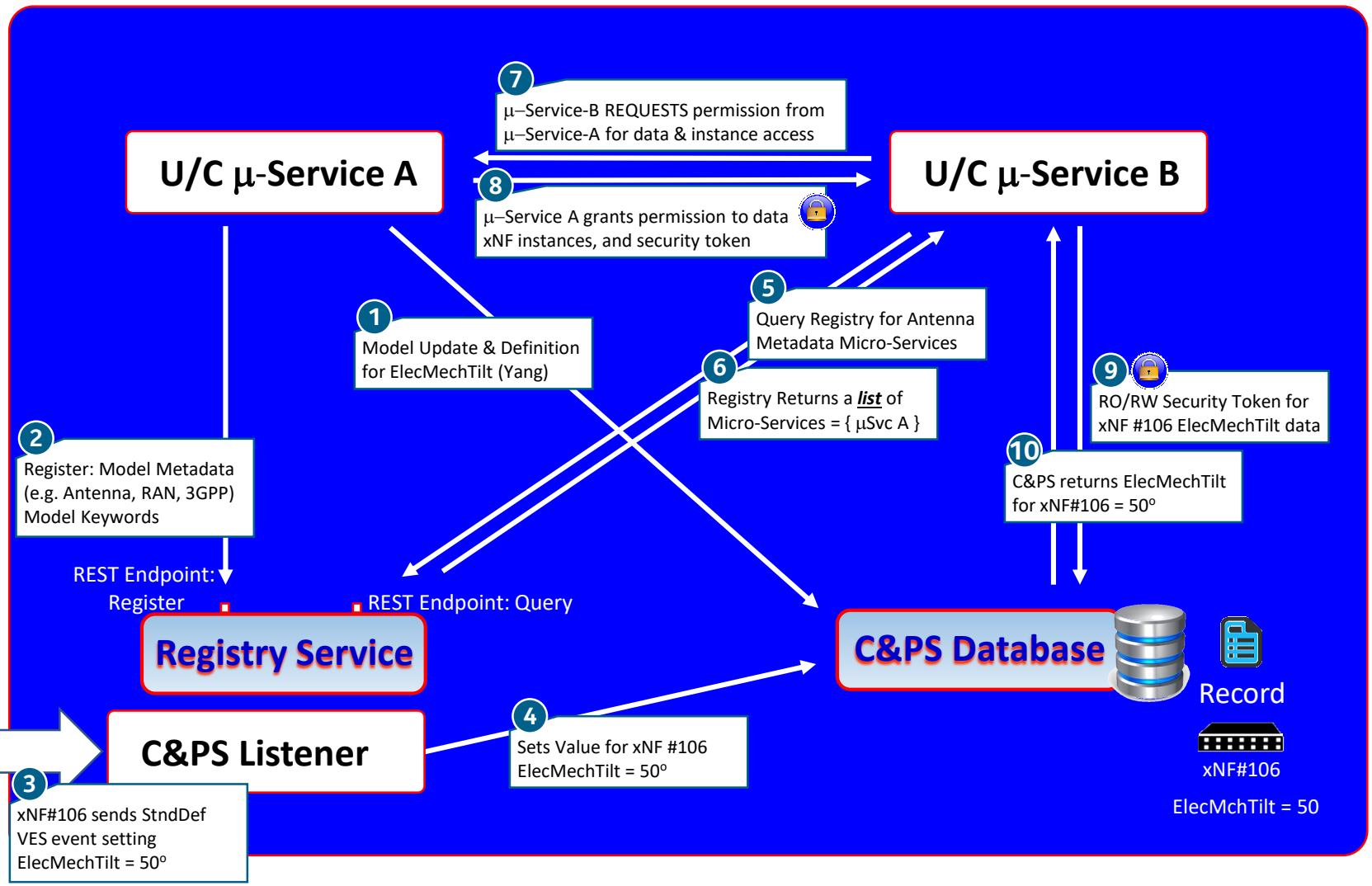

Modeling Sept 14, 2020

Responsibility to set keywords

Deciding in a model can be used as a keyword

Platform activity; or owning mS ; on onboarding ; inherit to model

“fixed dictionary” , “manual entries”, “automatic dynamic collected from model”

Metadata info in the model?

Example of Keywords / Metadata:

5G 3GPP RAN (this model has “base” 5G NRM data) -> 3GPP TS32.540/541

ISOMII (Optical model)

Wireless / Transport / Wireline

Area-A, B, City-xyz

Types of Hardware (Antenna, Base station, Core)

Analytics mS

OOF SON PCI – cells (PCI)

E2E Network Slicing – wireless (RAN), Core [Domain]

KPI Performance Measurement Analysis – (domain, PM/KPI)

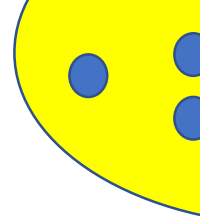

## DISCUSSION Friday Sept 4 & Friday Sept 11 C&PS Team Call

M-S#1 SDC>CSAR > creates CPSDB records “owner” (Mirror svc) gets model in raw form. mS#1 Hua mS#2 Er mS#3 nok

mS#4 “analytics”/”correlation” ... across domains/ across multiple vendors installations ... needs to ASK for access from mS#1,mS#2, mS#3 ... wants to traverse the data lake. Code will be coupled to different models. READ ONLY

Mechanism / **Registration component** “I am x” and I have models that relate to “a”, “b”, “c”

I am publishing the model

mS can **Query the Registry** – and can ask for access.

mS#1 Ericsson RAN -> body of RAN related PNF records -> “owns them”

-> register function -> publish ownership -> I’ve created these records, they are of this type, if you want access talk to me.

mS#5 BT (service provider’s mS) -> certain kinds of data ... -> **query/crawl/search the registry** -> “all RAN record” -> mS#1

Once mS#5 has been given access, mS#1 grants access to mS#5 access to the data.

mS#5 “release access” done using the data.

When you request reg users, anyone who wants access needs to call the reg

Expose the reg, grant all read requests.

# C&PS READING: PNF Reports Configuration

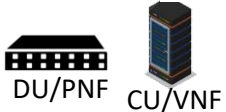

PNF  
VNF

VES  
Event

Standards Defined  
VES Event  
for Configuration

The PNF has a parameter update to report. The update originates from the PNF and is reported through a Standards Defined VES event with a configuration NameSpace (3GPP-Provisioning)

1

DCAE VES  
Collector



DCAE Inventory

DCAE  
Analytics

**Standards Defined VES Event** is received by the *DCAE VES Collector*. DCAE publishes the VES Event onto the DMaaP Bus.

3GPP Mapper (DCAE)  
Map stndDef VES event  
onto existing VES event

DMaaP

Configuration NameSpace topic  
3GPP-Provisioning

C&PS Update

**In R8+:** CPS as a stand-alone component, subscribes to the DMaaP Topic and gets the DMaaP event from the DMaaP bus to update the internal database. The VES event has a Configuration namespace topic, 3GPP-Provisioning

Config & Persist  
Service



C&PS Database

Run-Time Operational Data  
Configuration Info  
Exo-Inventory Data  
RT Logical & Physical Connections



# C&PS Roadmap & R6-R8 Plan



## Configuration & Persistency Service (CPS) Roadmap –

R6 Frankfurt

R7 Guilin



R8 Honolulu



### C&PS 1.0

#### R6 C&PS

- CC-SDK/SDN-C solution
- Evolution of “ConfigDB”

#### Supporting R6 Use Cases:

- SON/OOF/PCI U/C

June 5, 2020

### C&PS 1.1

#### R6 C&PS Extensions

- Evolution of CC-SDK/SDN-C solution REQ322

#### Supporting R7 Use Cases:

- SON/OOF/PCI U/C
- 5G E2E Network Slicing
- A1 Policy extension (Ericsson)

#### Model-Driven PoC

- Write “base” C&PS
- Write NE Data
- Read NE Data
- Access Control

#### State Management PoC

- State Management PoC (BellCA) self-contained

December, 2020

### C&PS 2.0

#### R8 C&PS stand-alone project proposal

- Deprecate C&PS 1.0 & 1.1
- Project proposals TSC/Architecture S/C
- Setup Project Repo

#### CPS FUNCTIONALITY:

- Data Recovery
- Model Adaption (Dynamic Schema)

June 2021

Legend:

RED text is CC-SDK/SDN-C solution

BLUE text is the PoC & stand-alone project

# U/C Realization call with Yuriy

## Current Status of 5G NRM Configuration

This is a new UC will start in R6.  
Presentation in LFN DDF is [here](#).  
High-level Design:

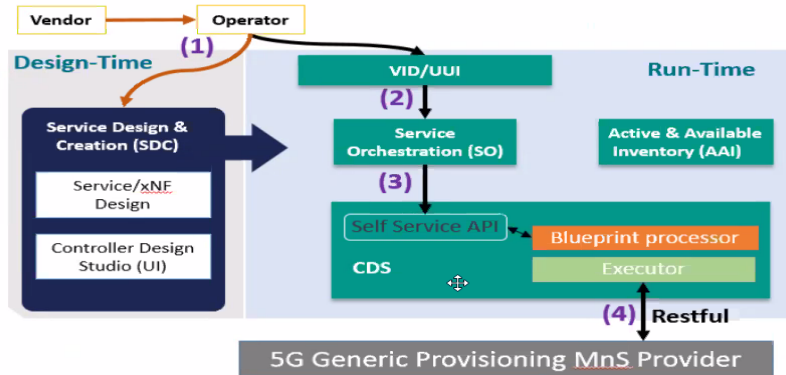

<https://wiki.onap.org/display/DW/5G+Network+Resource+Model+%28NRM%29+Configuration+in+R6+Frankfurt>

Modeling, extend CDS. ... database can model itself use CBA package to capture that file

Don't intro a specific artifact in SDC.

Include as part of the CBA artifact.

Onboard the yang model ... in the onboarding module, the CBA blueprinting script can read the module from the Package.

The CB script read yang model from local CBA package, could read yang model file from OB package.

Instance data – instance PNF – don't involve the models (capabilities of xNF); creating data to apply CM data.

The data itself must be compatible w/ what the xNF supports. No checks usages of model info on ONAP side.

Responsibility of the user to verify to operate correct.

Responsibility of vendor modify the xNF. File w/ configuration to apply , needs compatibility w/ xNF.

SO API. Users of SO API needs to supply data compatibility w/ VNF.

CDS input information to CBA doesn't need modeling input.

For C&PS is doesn't need CDS, a macro-service to get & create dynamic schema.



# PNF Onboarding Package (CSAR)



## PNF Onboarding (CSAR file)

### Note:

- Package Example
- Not all files are listed.
- Folder / file name in blue is requested by SOL004.
- Folder / file name in black is example only.

TOSCA-Meta-Version: 1.0  
 CSAR-Version: 1.1  
 Created-By: Ericsson (Zu Qiang 2018-12-03)  
 Entry-Definitions:  
 Definitions/MainServiceTemplate.yaml  
 Entry-Manifest: MainServiceTemplate.mf  
 Entry-Change-Log: Artifacts/ChangLog.txt  
 Entry-Tests: Artifacts/Tests  
 Entry-Certificate: Artifacts/License\_term.txt

### ROOT

- TOSCA-Metadata
- Definitions
- Artifacts
- MainServiceTemplate.mf

TOSCA.meta

NF descriptor

MainServiceTemplate.yaml

**NonMANO artifacts (keyword)**  
**NRMYang or NRMAnsible**  
**5GNRM . (Yang/ansible)**

**(one possible location)**  
**NRM.Ansible**

**(one possible location)**  
**NRM.Yang**

- Images
- Deployment
- Scripts
- Tests
- ChangeLog.txt
- MainServiceTemplate.cert
- License\_term.txt

- Configuration
- Yang\_module
- Measurements
- Events
- ...

yang-module.yang

pm-dictionary.yaml

- Install.csh
- ...

ves-dictionary.yaml

### metadata:

pnf\_product\_name: gNB  
 pnf\_provider\_id: Ericsson  
 pnf\_package\_version:1.0  
 pnf\_release\_date\_time:2018-12-03T08:44:00-05:00  
 non\_mano\_artifact\_sets:  
 Events:  
 source:  
 Artifacts/Deployment/Events/VES\_registration.yaml

# Onboarded Package to SDC Internal Mapping

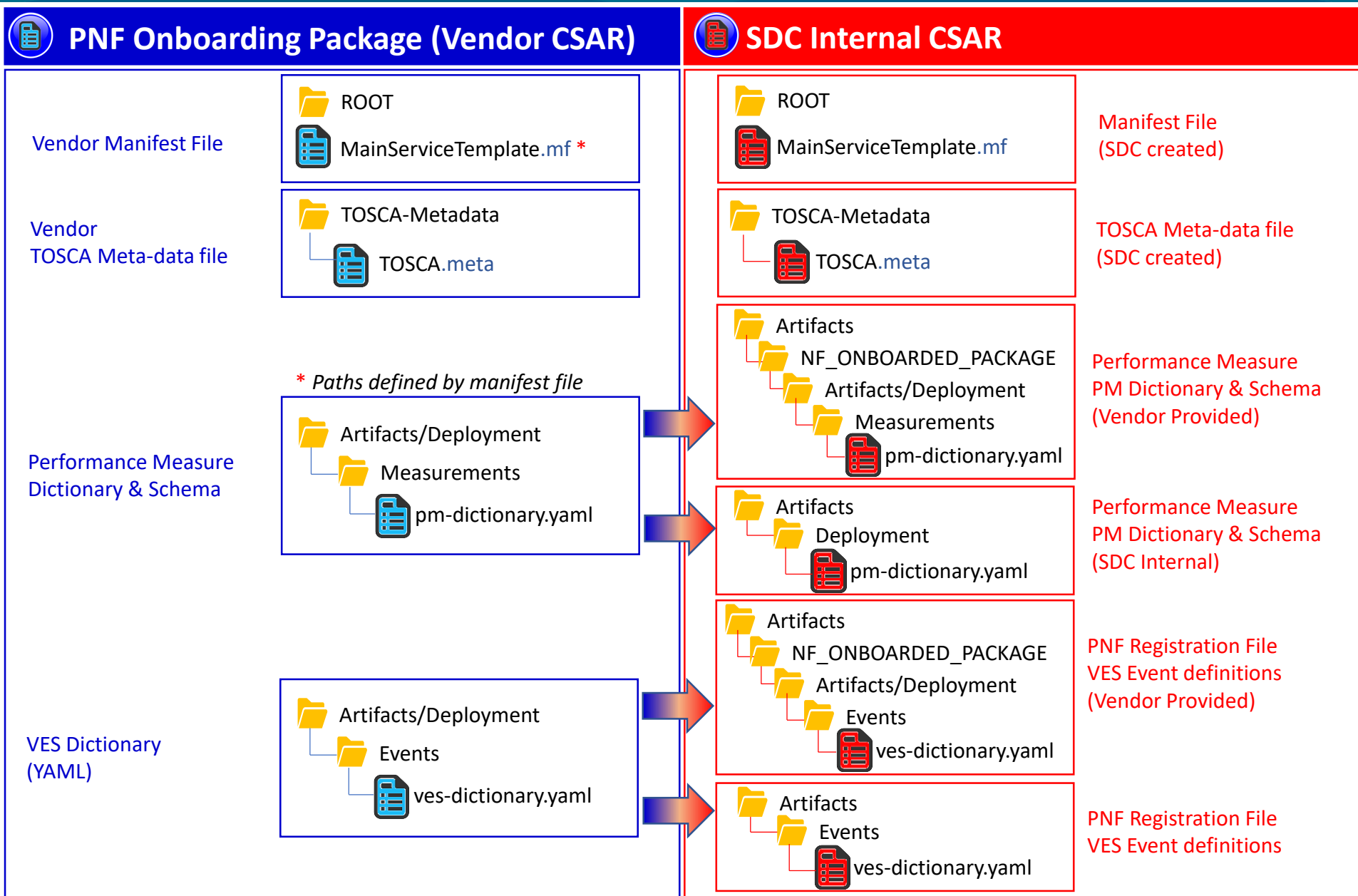

ETSI Alignment R7 U/C

Sept 1

SDC network service CSAR (new)

SDC service definition might refer to a network service

Network svc is a sub-set of service kept as a separate unit, i.e. a topology

Topology of xNFs. Nested network services.

SDC output -> service & associated network service CSAR (0 or more)

Would the network service CSAR ALSO include these resource xNF NRMs?

xNF might be buried inside a nested service.

References between service CSARs & network service CSARs.

In an instantiated service, go from svc instance > network svc instance > resource instance.

ETSI Package Directory

This is a refinement in papyrus model about the relationship between ETSI NSD and AID SD, changes are expect to explain 1)ONAP has 2 kinds of service model, one is AID SD, one is NSD, they both belong to DesignEntity, 2)NSD (SD) can nest NSD(SD) , SD can nest NSD in some use case

## Changes

### 1. Service Descriptor with NetworkServiceDescriptor reference

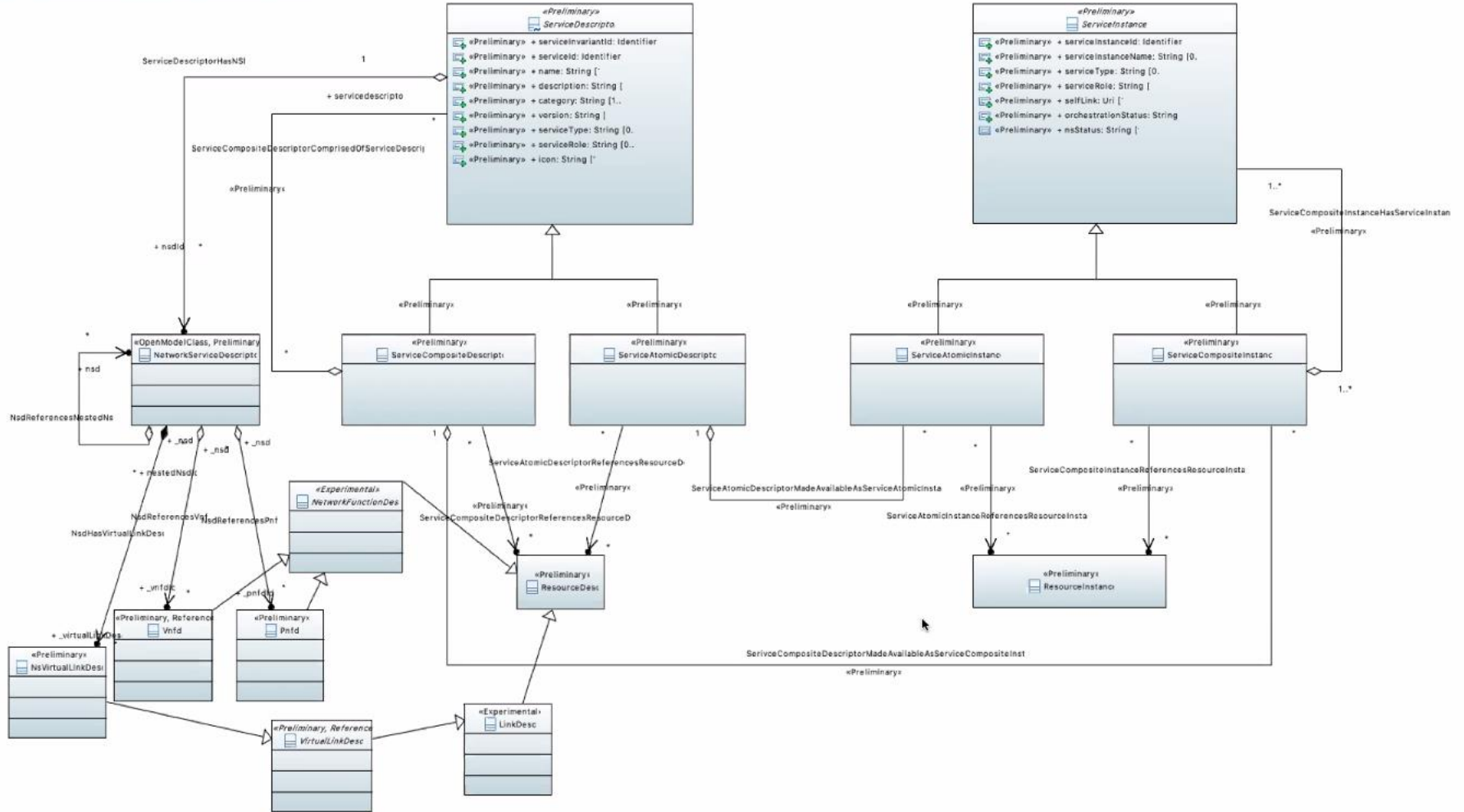

2.

3 NetworkServiceDescriptor Diagram

# VNF/PNF PACKAGES

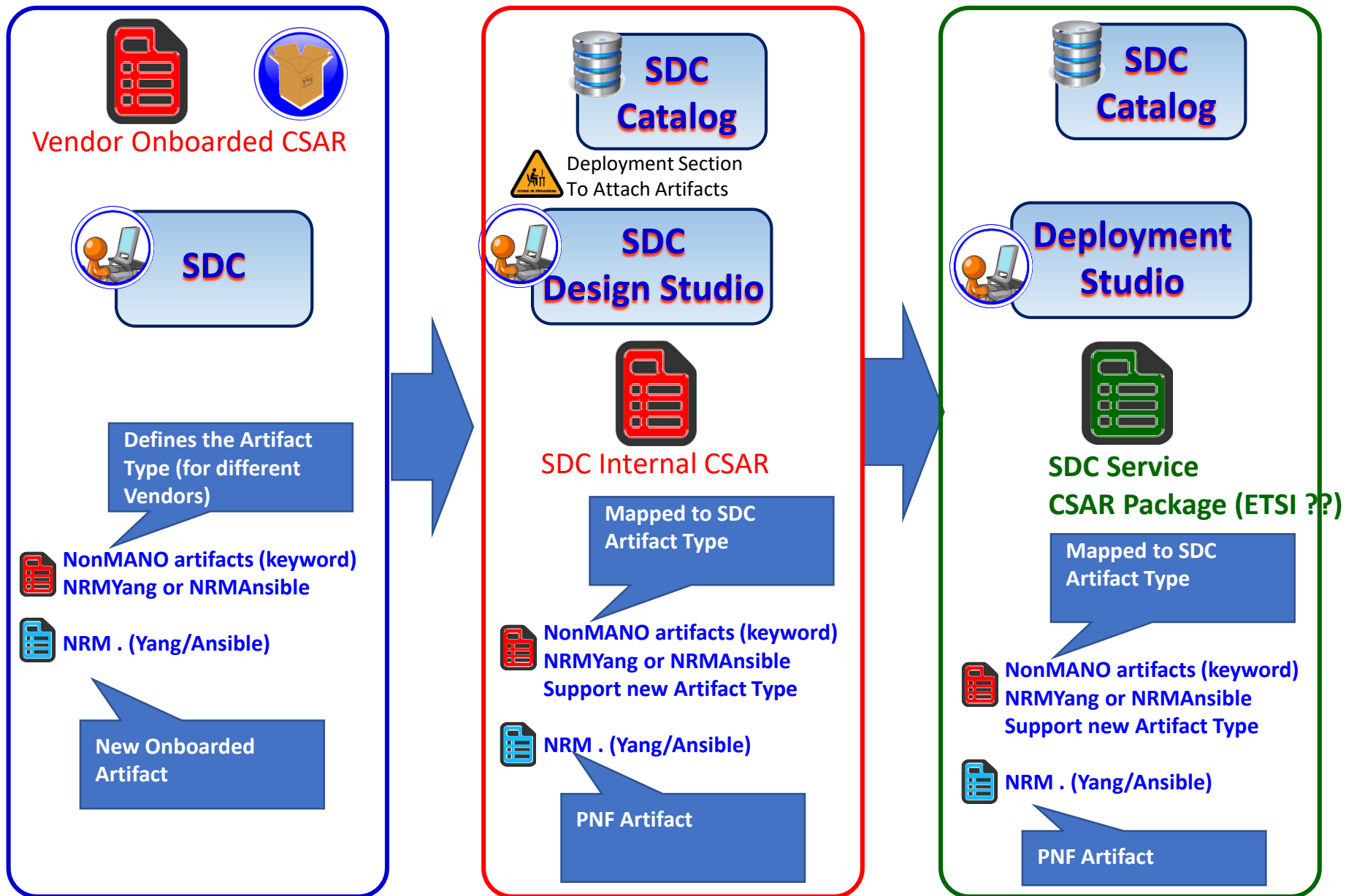



(Zu) Use case driven, in current use cases, use SDN-C

For node configuration, C&PS stores the config data

Need to understand the application model, no other run-time component

Needs this model, so it would be nice to **NOT** significantly change the PlfrmInfoModel

The 3GPP model is well-defined, doesn't make sense for ONAP to redefine it.

CNF/VNF (Fred) the generic APP-C using CDS as the modeling approach would fit this model well. Intended to

Encompass application model, and deal w/ configuration manipulation of application model > turn into

Specific implementations. CDS & APP-C . xNF consideration. General abstraction problem

Unification strategy to join SDN-C and APP-C into one entity. Yuriy for CDS.

CDS – GUI – define the (3GPP model) model that you can import; enable you to input the model and instance specific configuration to talk to each instance. Define models for manip application data. Define a model (importing the 3GPP model) and have the manipulation svc to implement the configuration associated w/ the xNF.

**ACTION ITEM**: PNF resource instantiated by ONAP. The issue of non-unification. Could interact w/ PNF. Yuriy.

(Andy) Maybe we introduce “core” sub-model to the Platform information that might accompany the G-A-M solution. Creating a “hybrid” solution, where the G-A-M serves the MAIN data model for xNFs, and this adjunct model maybe a way to SUPPLEMENT the P.I.M. w/ information that G-A-M solution falls short on, (1) isolates the changes thus there is not a big change to the P.I.M. (2) covers all the bases, “management level” that G-A-M 100% sufficient.

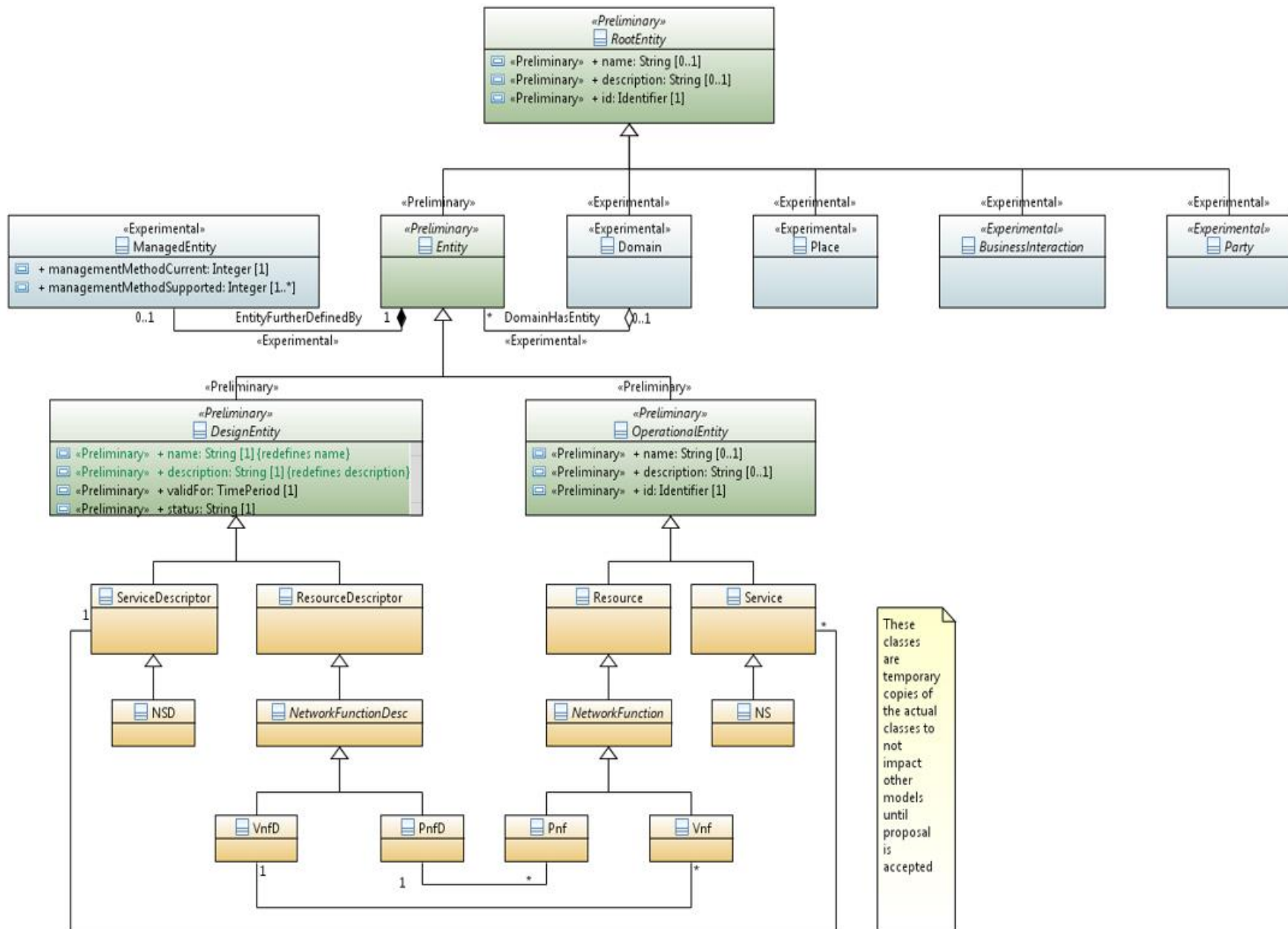



These classes are temporary copies of the actual classes to not impact other models until proposal is accepted



# PNFD Model



-  CP1 CP1 to CP6: Ext connection points (e.g. Control plane, data plane, management, etc)
-  NsVL1 NsVirtual link for each type of connection types  
Note: These VL may also can represent transport network technologies used.
-  ECP7 CP7: Ext connection point(s) for network core elements.

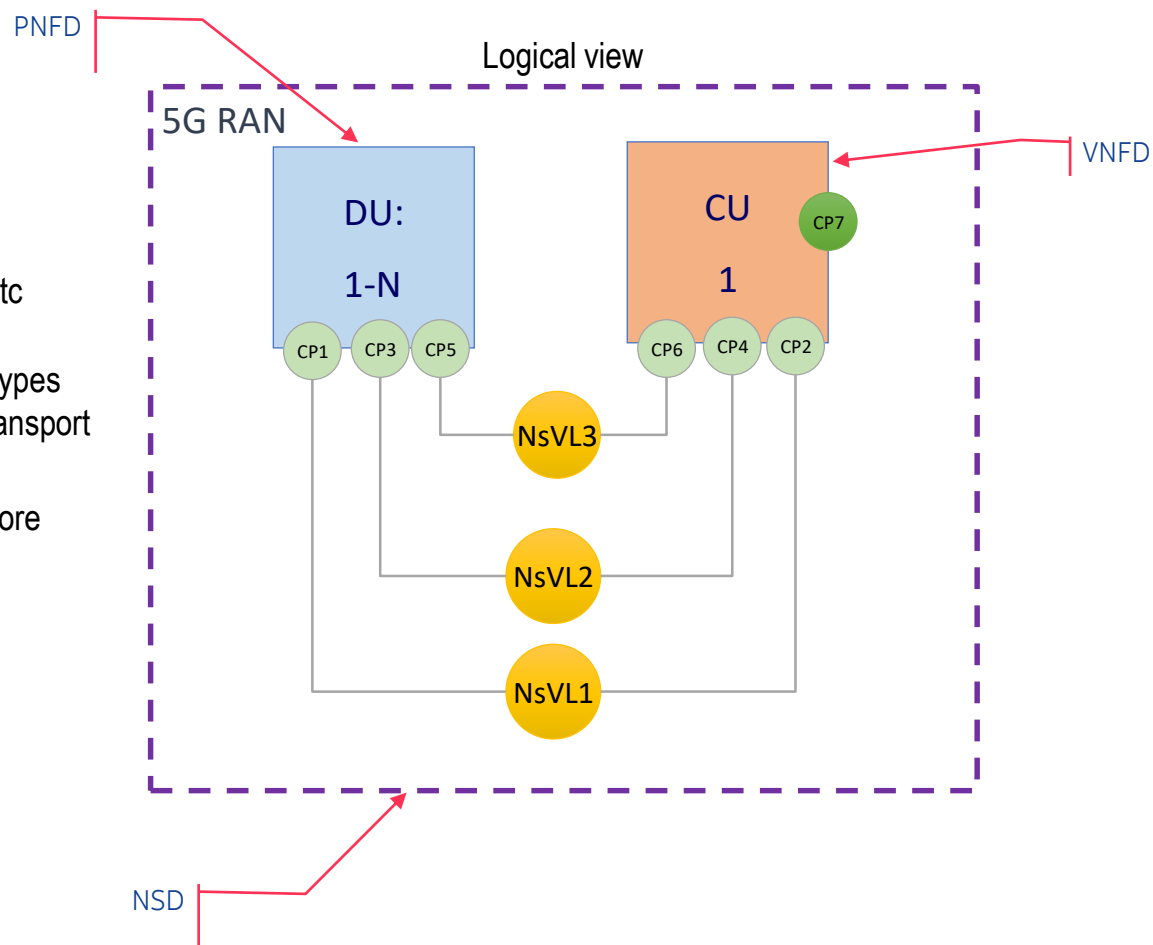

# Example: TOSCA Service Template



```
tosca_definitions_version: tosca_simple_yaml_1_2
description: 5G RAN simple example
imports:
  - etsi_nfv_sol001_nsd_2_6_1_types.yaml
node_types:
  tosca.5gexample_NS:
    derived_from: tosca.nodes.nfv.NS
    properties:
      descriptor_id:
      flavour_id:
topology_template:
  substitution_mappings:
    node_type: tosca.5gexample_NS
  requirements:
    virtual_link: [ CU, virtual_link_XYZ ] # the External connection point of CU
node_templates:
  my_5gservice:
    type: tosca.5gexample_NS
    properties:
    interfaces:
      Nslcm:
CU:
  type: tosca.nodes.nfv.5Gexample_VNF1 # this type is described in another service template
  properties:
    flavour_id: simple
    vnf_profile:
  requirements:
    - virtual_link_1: NsVirtualLink_1
    - virtual_link_2: NsVirtualLink_2
    - virtual_link_3: NsVirtualLink_3
DU_1_to_N:
  type: tosca.nodes.pnf.5gexample_DU # the description of this type is described in another service template
  properties:
  requirements:
    - virtual_link_1: NsVirtualLink_1
    - virtual_link_2: NsVirtualLink_2
    - virtual_link_3: NsVirtualLink_3
    - dependency: CU
NsVirtualLink_1: #
  type: tosca.nodes.nfv.NsVirtualLink
  properties:
    connectivity_type:
    vl_profile:
NsVirtualLink_2: #
  type: tosca.nodes.nfv.NsVirtualLink
NsVirtualLink_3: #
  type: tosca.nodes.nfv.NsVirtualLink
# omitted here for brevity
```

# Creating a 5G Service



Need to create a 5G service in R6

- Currently individual services can be created using VNFs and PNFs
- Modeling of 5G NFs is work ongoing in Platform (Internal) Info Modeling Committee
- Architecture sub-committee needs to approve modeling committee proposal before requirements can go to SDC
- SDC needs to receive requirements so service models can be created
- Schedule in R6 M0 (Sept 5 2019).
- 5G Use Case Proposed for R6.
- “Target” 5G Service. Multiple options. 3GPP options 2/7/8. Based on U/C.

# Creating a 5G Service



- Config DB (MariaDB) used by PCI-H-MS (step 4b) and OOF (step 7)
- Query API (swagger JSON spec) exposed to other ONAP modules
- cellId needs to be globally unique (assumed eCGI) and align with ONAP YANG model, ORAN, 3GPP
- pnf-name/pnf-id indicates netconf server to be used for interactions regarding cells
- 'ho' property added to support ANR use case

Cell (Object)	
Attribute	Format
networkId	string
cellId	string
pciValue	uint64
nbrList	list of cellId
lastModifiedTS	timestamp
pnf-id	string

Cell_Nbr_Info (Object)	
Attribute	Format
cellId	String
target_cell_id	String
ho	BIT(1)



# Cell Management, Cell object, Cell Configuration



Benjamin Cheung, PhD

# Cell Definition



DEFINITION: Cell in wireless communication technologies, the geographical region that is covered by a transmission facility. The term «cell» is most often used in reference to cellular phone technology, but it can also be used in reference to the coverage areas for transmission of cordless telephones, satellite transmissions, wireless local area networks (LANs), packet radio, and paging technologies.

<https://networkencyclopedia.com/cell-in-wireless-communication/>

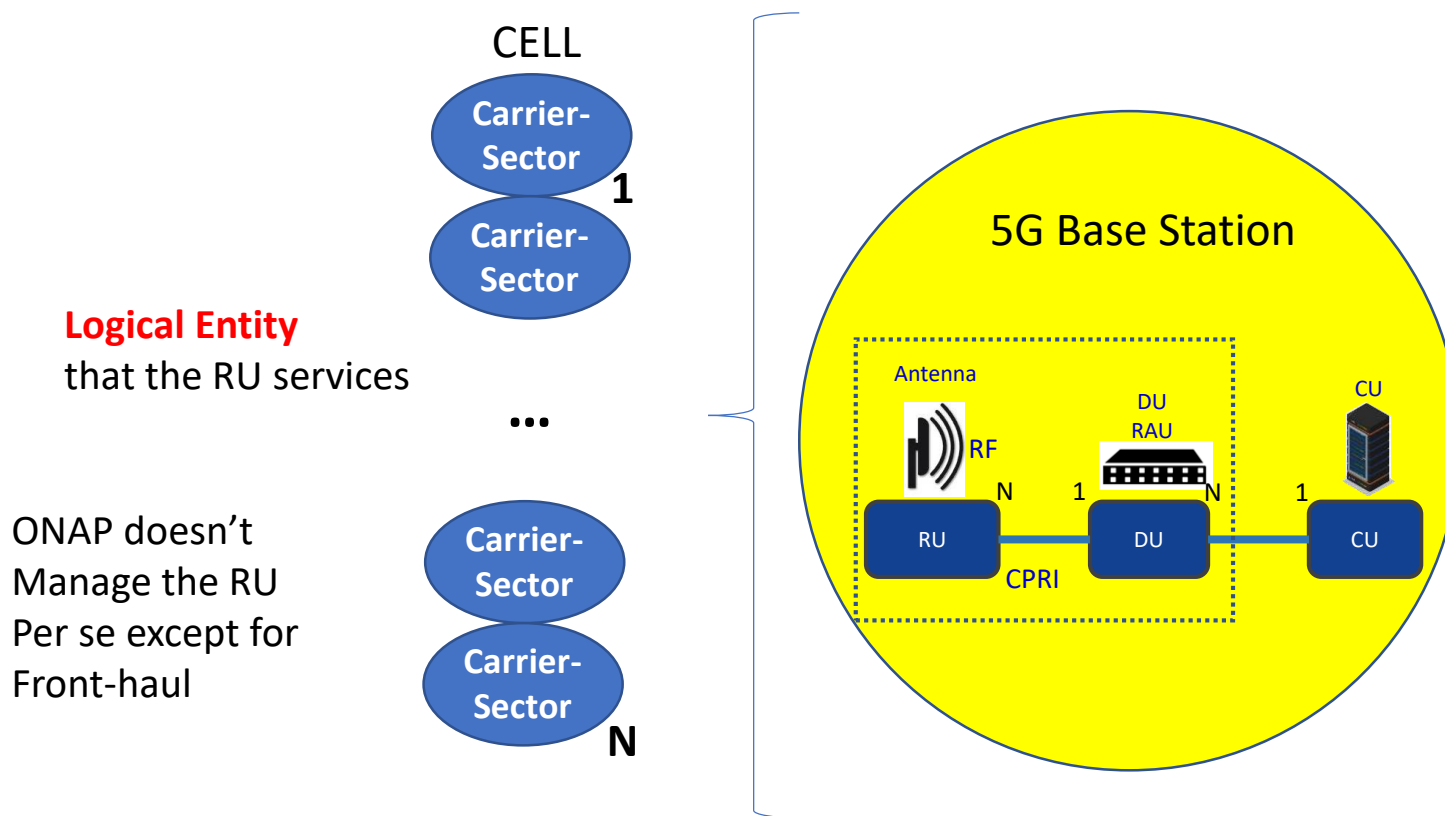



## VISIBILITY / EXISTENCE OF CELL

### 1 USE CASES –

1a **E2E Network Slicing** - Slicing – xNFs involved in a slice (TA/RA), where is the “slice” stored? NSI in A&AI. Alloted NF (ANF). Slice Service.

1b **OOF/SON/PCI** What use cases are Using it – OOF/SON/PCI which needs to store some cell info, KPI HO success rate. CellID. What Attributes to update. Key Identifiers. Neighbor Lists.

2 **EXISTENCE** - does ONAP need to know of existence of Cell? What does it need to know about a Cell?

## MANAGEMENT OF CELL

1 **LIFE CYCLE** - Life Cycle of a Cell (FCAPS); OA&M interface at ONAP (no interface) **all the information related to a cell is reported/retrieved from the DU.** -> ONAP command “xyz Cell” (add/del/ onboard). ONAP would not “manage” a cell at all; it would manage a DU -> rather information for a cell (adds/deletes) are covered by the C&PS database solution.

2 **FUNCTION** - What would it do with a Cell

3 **ADD/DELETE** - For add/delete Cell case -> the corresponding activity in ONAP is to add/delete C&PS database entry. The DU informs ONAP that a Cell is added/deleted, then C&PS updates database accordingly. ONAP management level to add/delete would be a configuration update.

4 **MODELING** - How would it Model it? (Info Model). A DU is a MOC. A Cell is a Logical object. -> No modeling is needed.

## INFORMATION ABOUT CELL

1 **PERFORMANCE MANAGEMENT** - Cell specific KPIs, PM generated & reported from **DU**. COUNTERS collected & reported by the **DU**. KPI derived from counters. ONAP doesn't need to interact with a RU/Cell w.r.t. PM (Counters & KPI).

2 **CONFIGURATION MGMT** - Cell configuration info - Cell related information stored in C&PS.; Cell – A cell is a logical object. CDS. Cell related information is use case specific (PCI and E2ENS). (1) define, (2) store, (3) loop back to the xNF.

# C&PS Database (Run-Time View)

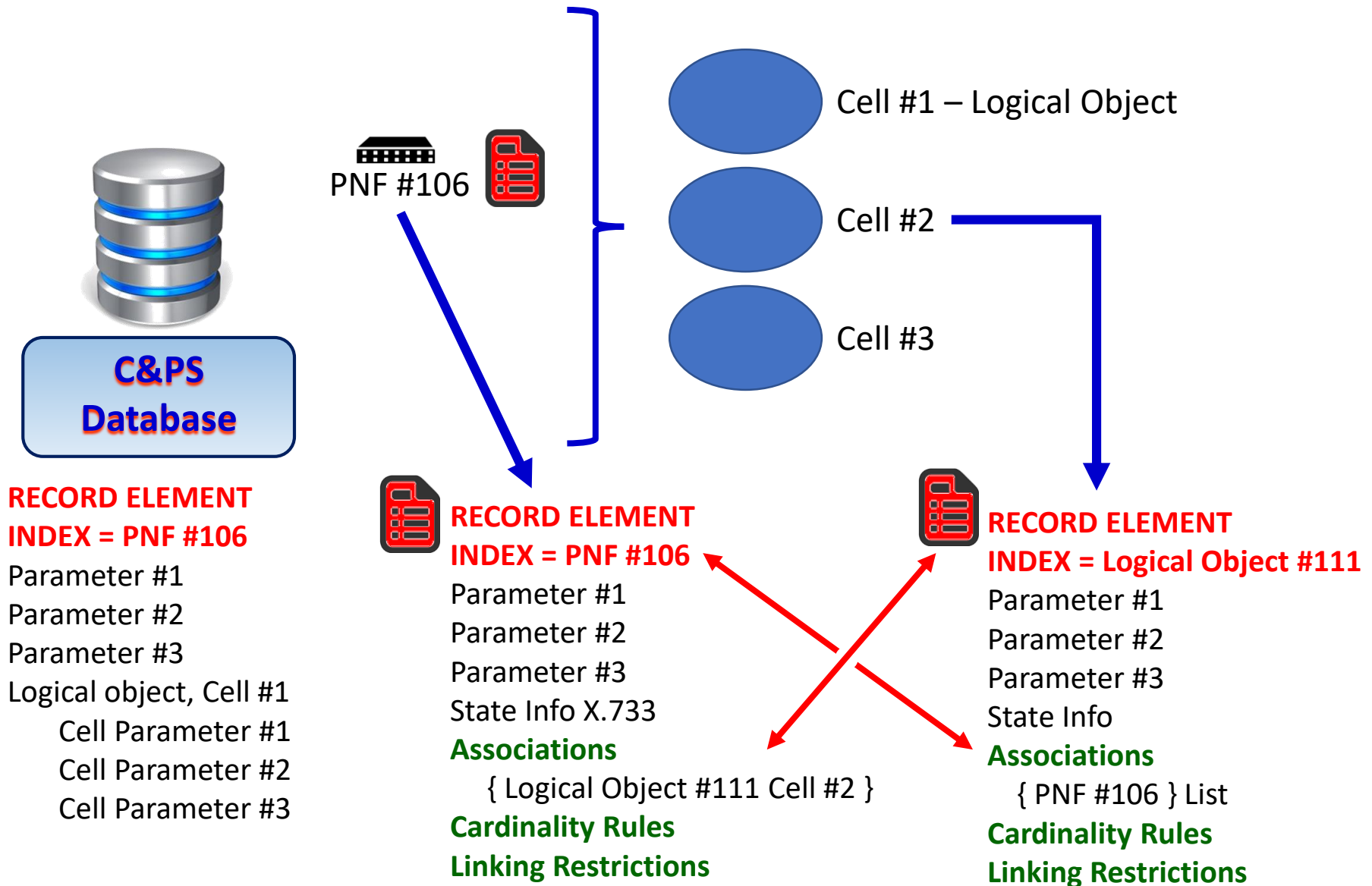



# Appendix





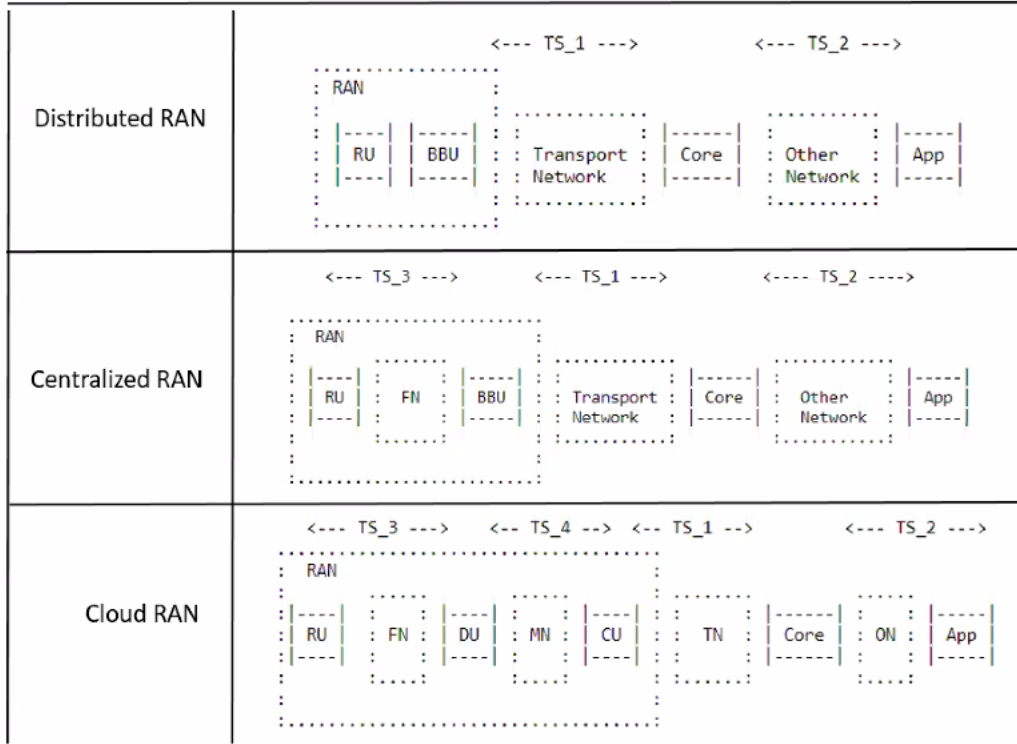

- An E2E Network Slice may consists of a set of TS instances, depending on the scenarios. Each TS instance defines the connectivity between two 5G domains. For example, TS\_1 defines backhaul connectivity; TS\_2, CORE to APP; TS\_3, Fronthaul; TS\_4, Midhaul.
- One TS consists of a set of networks (connectivity graphs). Each network has its own SLA. See next slide.
- One TS model for all TS instances in all scenarios.
- TSCi defines the TS model. And TSCi is the interface of the TN MD. It follows that the consumers of the TN MD could be E2E MD and/or RAN MD, depending on the scenarios. The TN MD does not care who the consumer is.



TS: Transport Slice  
 RS: RAN Slice  
 CS: Core Slice  
 FN: Fronthaul network  
 MN: Midhaul network  
 TN: Transport network  
 ON: Other network