

Illustrative Sequence Diagrams for Residential Broadband vCPE Use Case

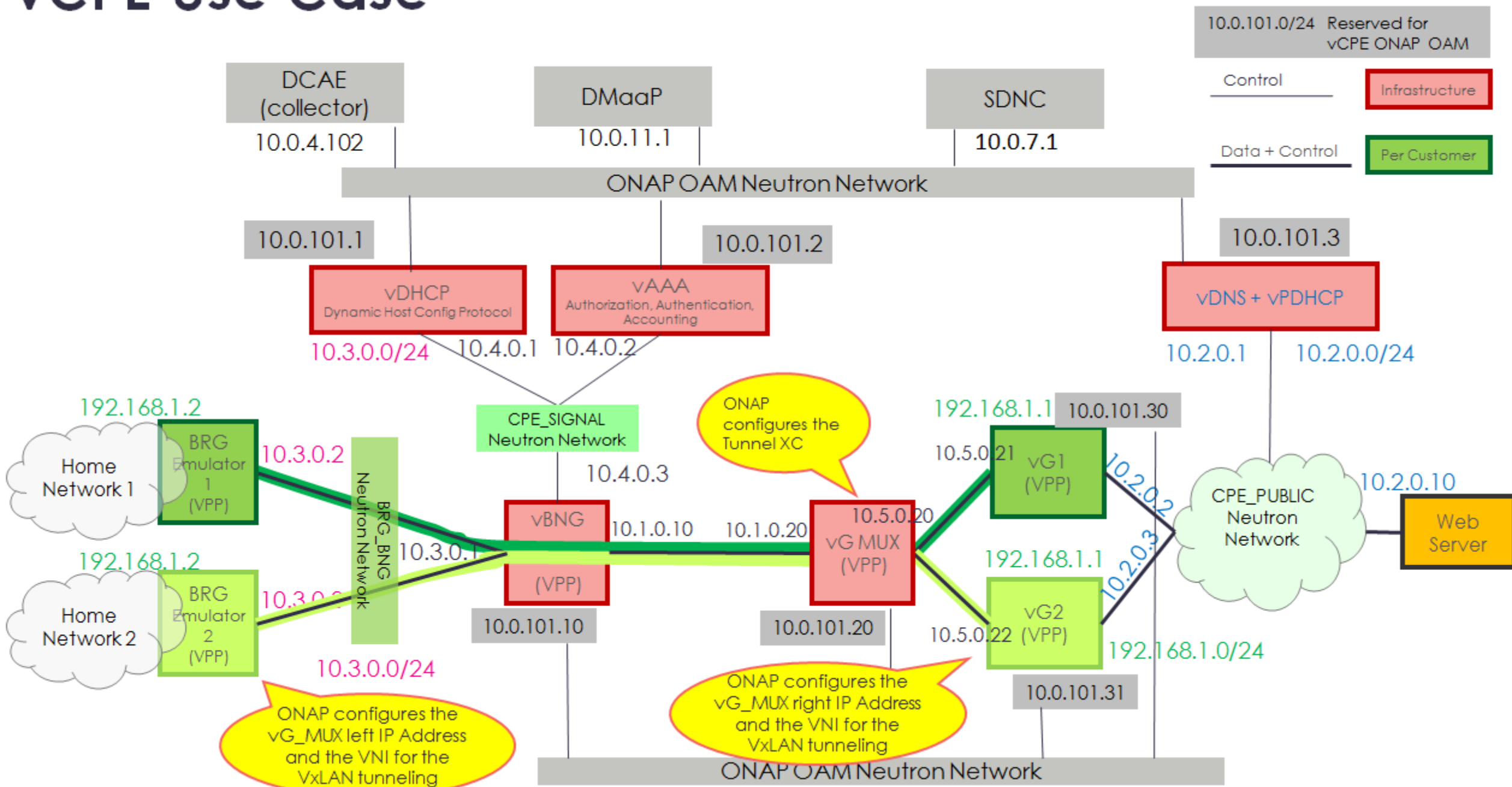

vCPE Use Case



Overview of Services Defined for vCPE Use Case

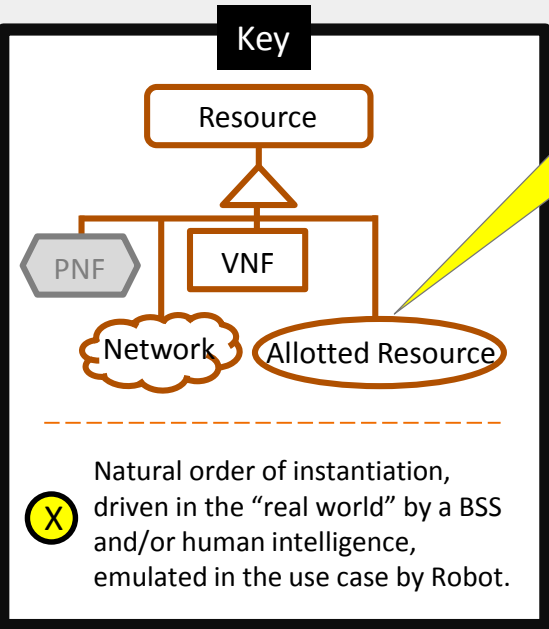

An "Allotted Resource" is the modeling representation of a "higher order" Service consuming a configuration/capacity allotment (instance) of a "lower order" Service.

The mapping of Resources into Services was made such that the Resources associated with a particular Service are those that would naturally be instantiated with the corresponding Service Instantiation request.

Not managed by ONAP in the "real world", so not modeled in the use case.

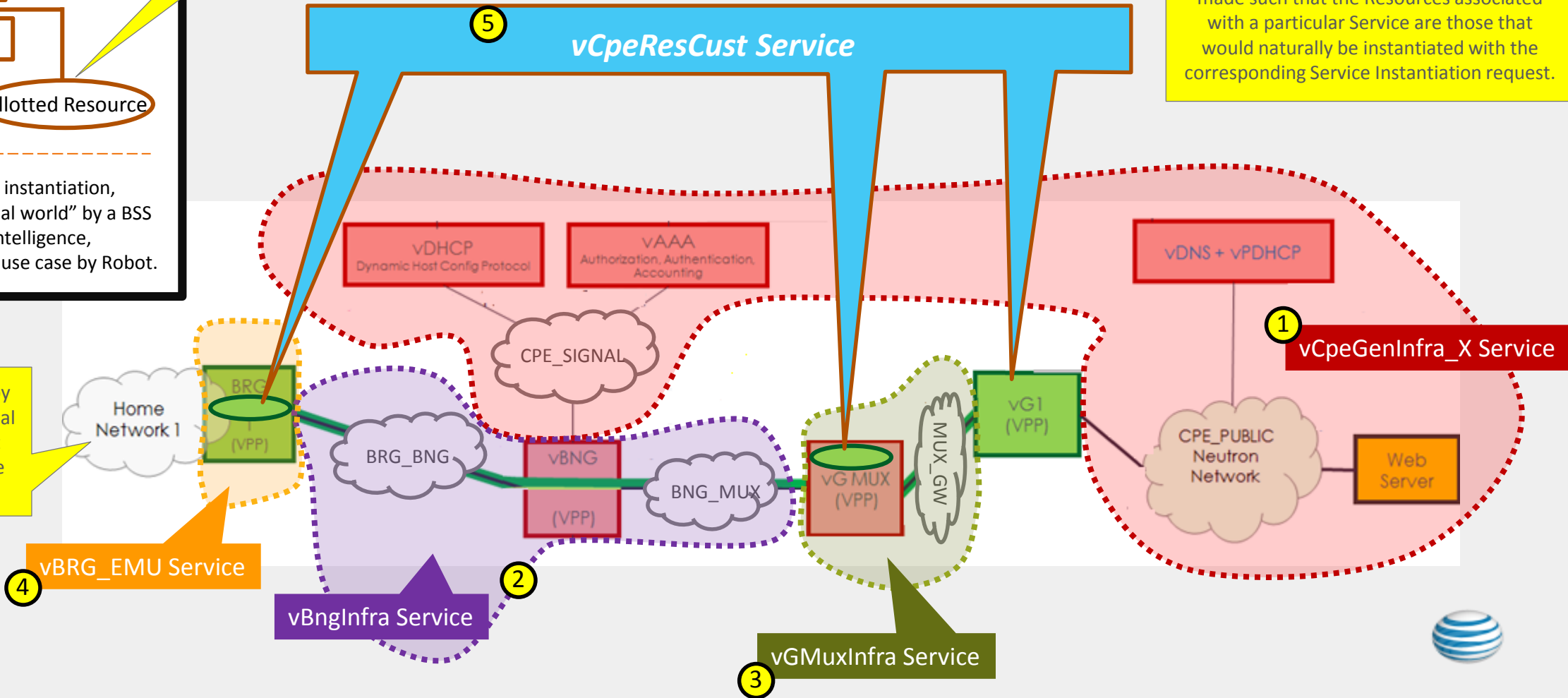

Residential Broadband vCPE Use Case Model: vCpeResCust & vGMuxInfra Topology

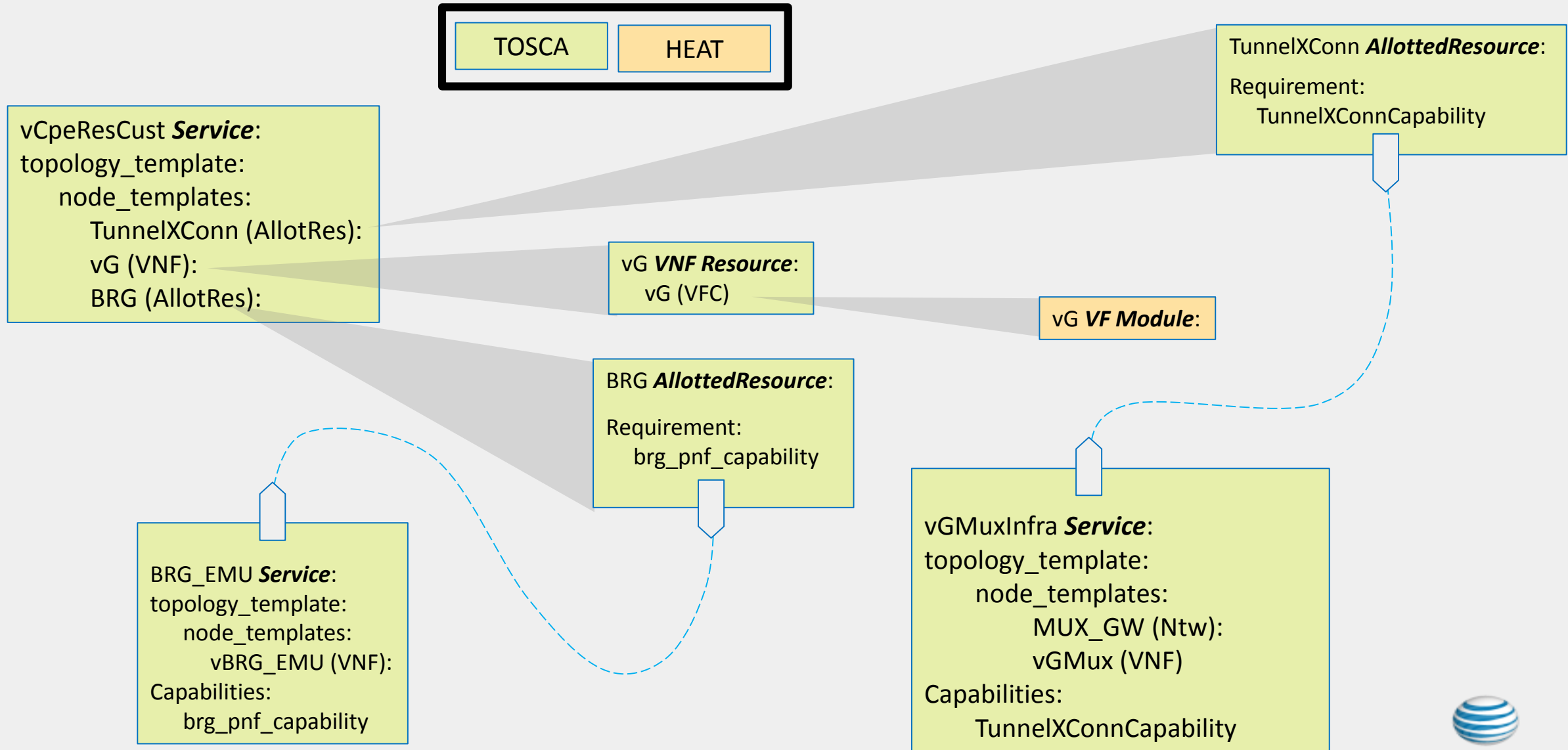

Residential Broadband vCPE Use Case Model: vCpeResCust & vGMuxInfra Topology

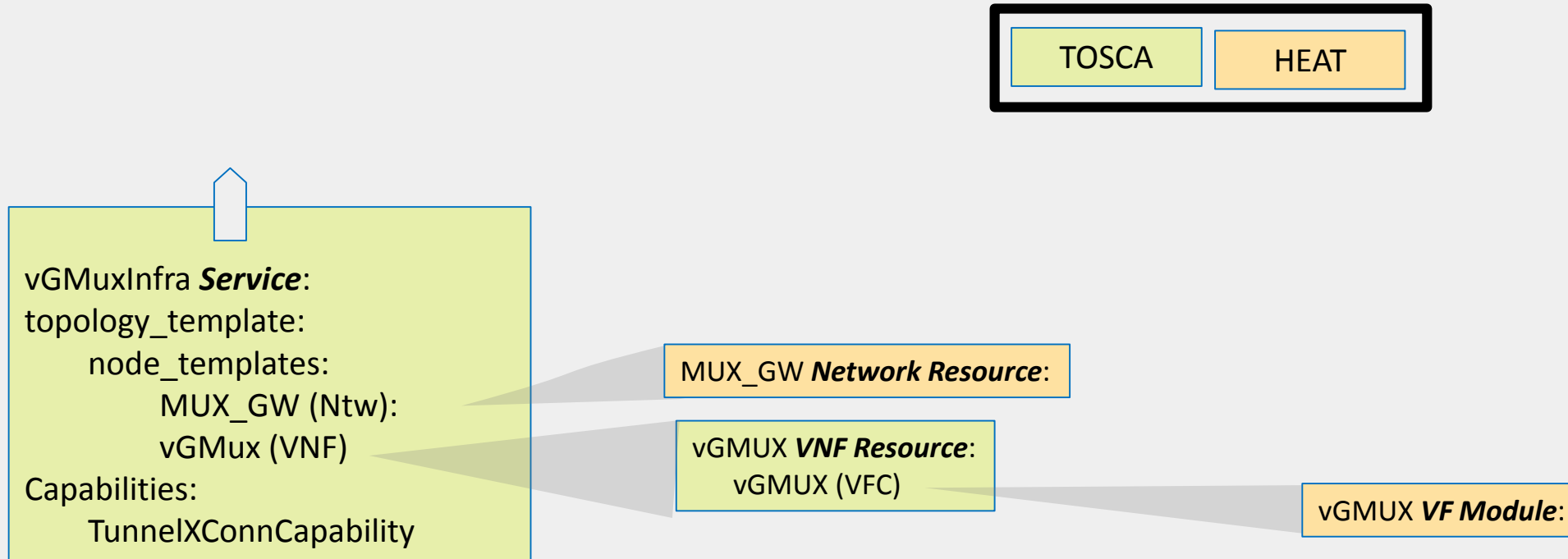

Residential Broadband vCPE Use Case Model: BRG_EMU Topology (Use Case Only)

The BRG_EMU Service is an artificial construct to leverage ONAP to instantiate the BRG Emulator, which is implemented as a VNF in this Use Case. This Service would have no analogue in the “real world”.

BRG_EMU Service:
topology_template:
node_templates:
 vBRG_EMU (VNF):
Capabilities:
 brg_pnf_capability

vBRG_EMU VNF Resource:
vBRG (VFC)

vBRG_EMU VF Module:

The vBRG_EMU VNF has no modeling relationship with the BRG Allotted Resource which is referenced in the vCpeResCust Service. The BRG Allotted Resource is designed to be useful in the “real world” in which a BRG is a true Allotted Resource, whereas the vBRG_EMU VNF is a construct that is useful only for standing up the BRG Emulator used in this Use Case.

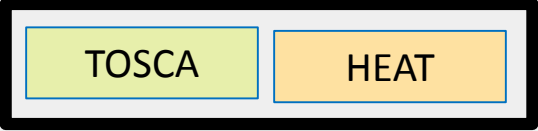

Residential Broadband vCPE Use Case Model: vBngInfra and BNG_MUX Topology

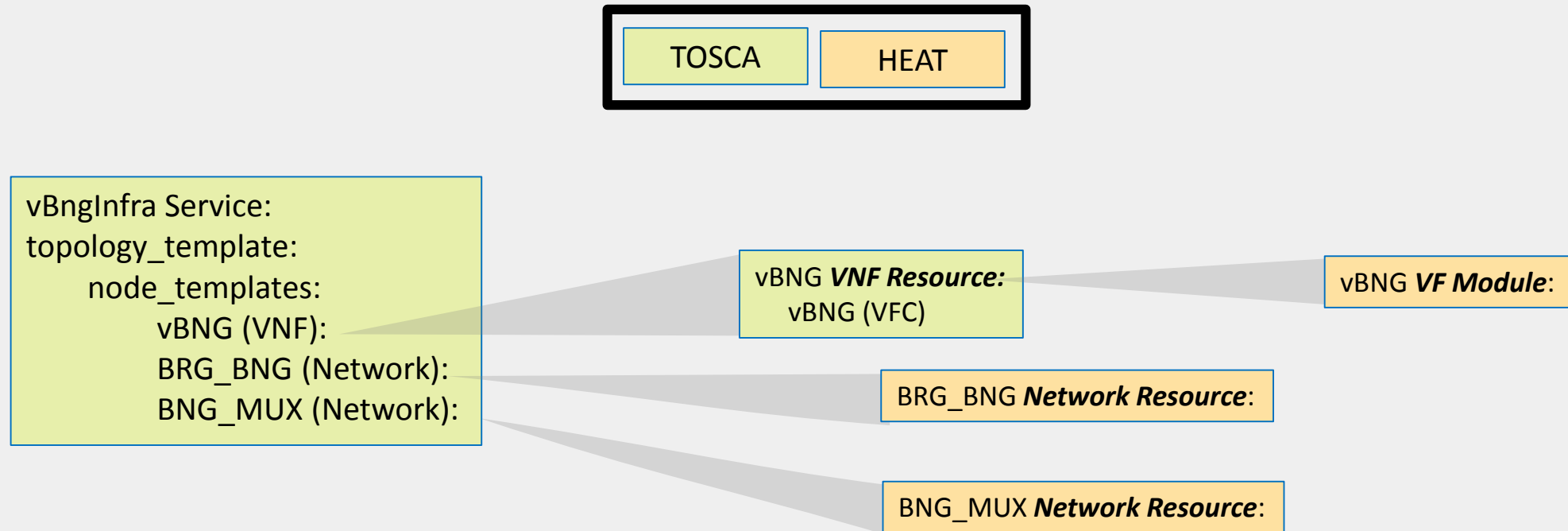

Residential Broadband vCPE Use Case: vCpeGenInfra Topology

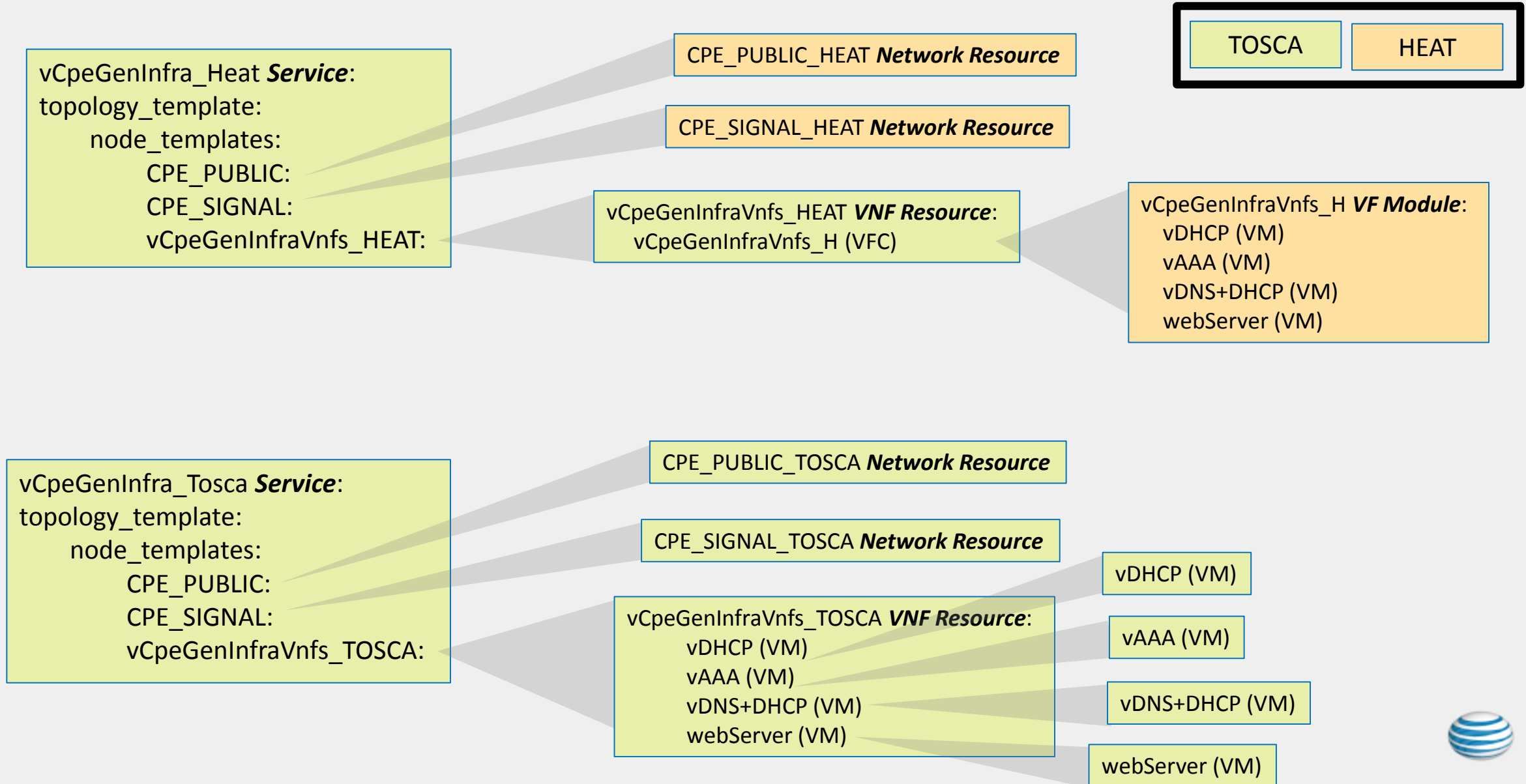

Residential Broadband vCPE Use Case Model: Infrastructure Instantiation Sequencing

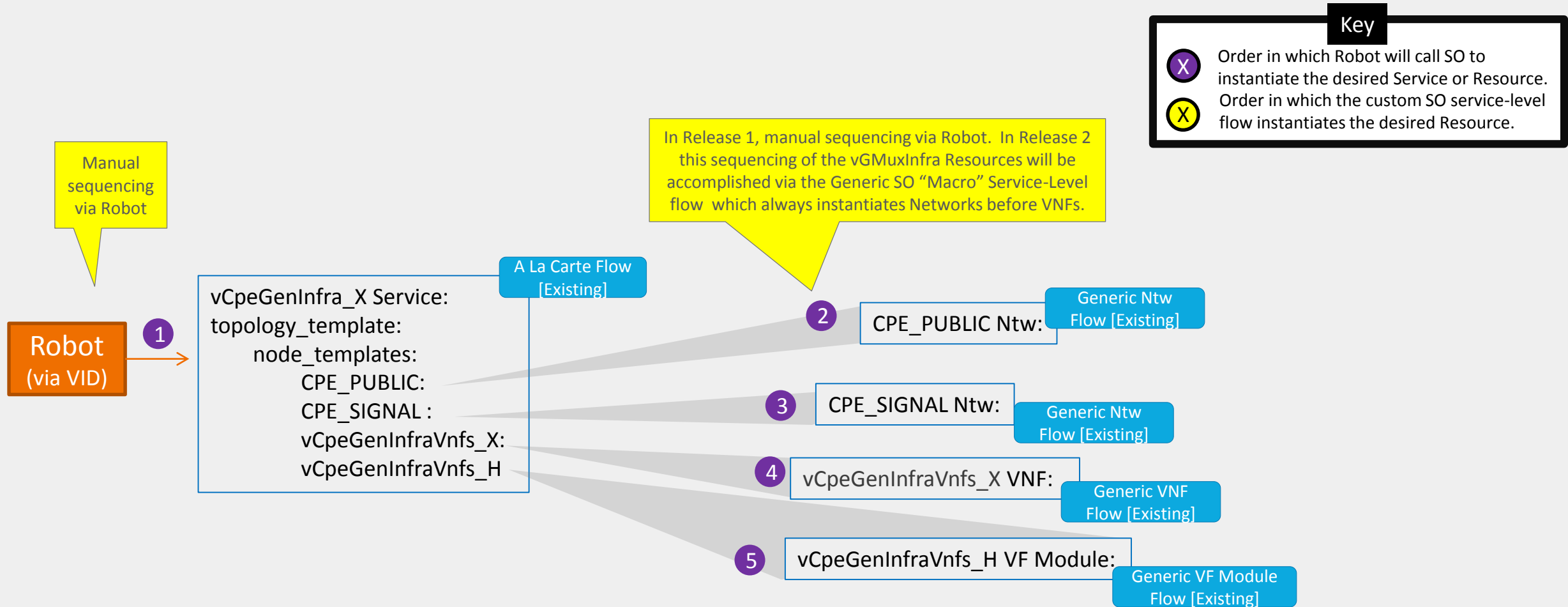

Residential Broadband vCPE Use Case Model: Infrastructure Instantiation Sequencing

In Release 1, manual sequencing via Robot. In Release 2 this sequencing of the vBngInfra Resources will be accomplished via the Generic SO "Macro" Service-Level flow which always instantiates Networks before VNFs.

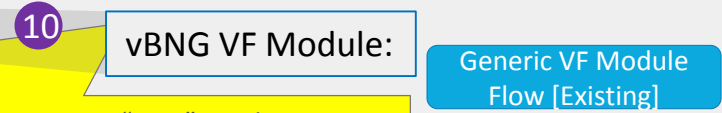
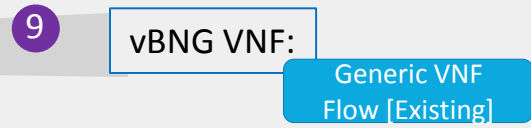
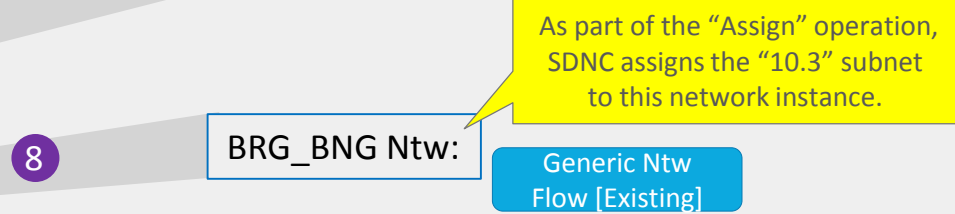
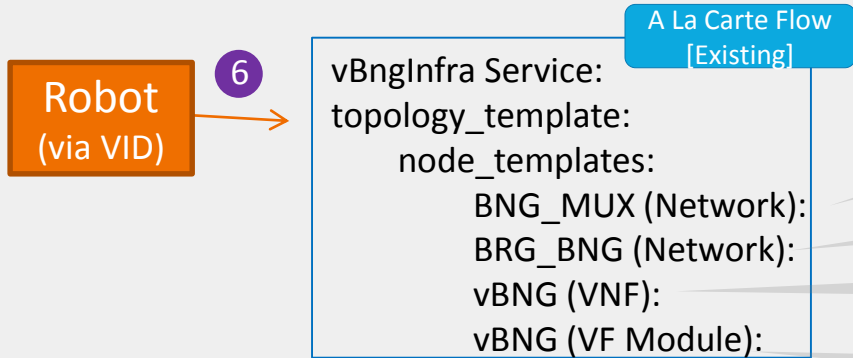

As part of the "Assign" operation, SDNC determines that the VF Module must connect to two networks: BRG_BNG "10.3" and BNG_MUX "10.1". It also assigns the IPs "10.3.0.1" and "10.1.0.10" at these networks. As part of the "Activate" operation, SDNC configures a static route between the 10.3 and the 10.1 subnets.

In Release 1, manual sequencing via Robot. In Release 2 this sequencing of the vGMuxInfra Resources will be accomplished via the Generic SO "Macro" Service-Level flow which always instantiates Networks before VNFs.

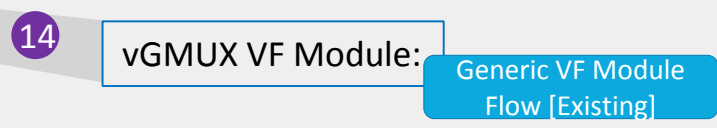
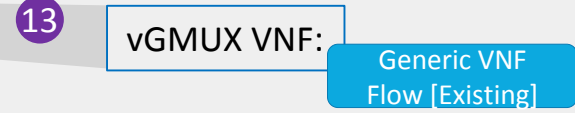
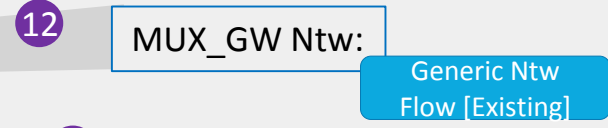
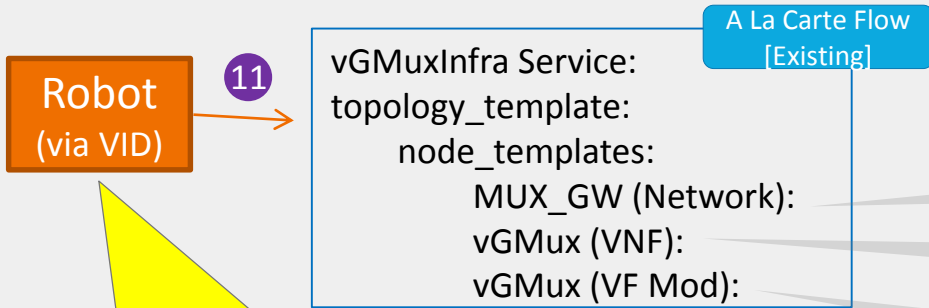

Manual sequencing via Robot. Robot will remember the vGMUX Cloud Region and the vGMuxInfra Service Instance UUID returned.



Residential Broadband vCPE Use Case Model: Instantiation Sequencing

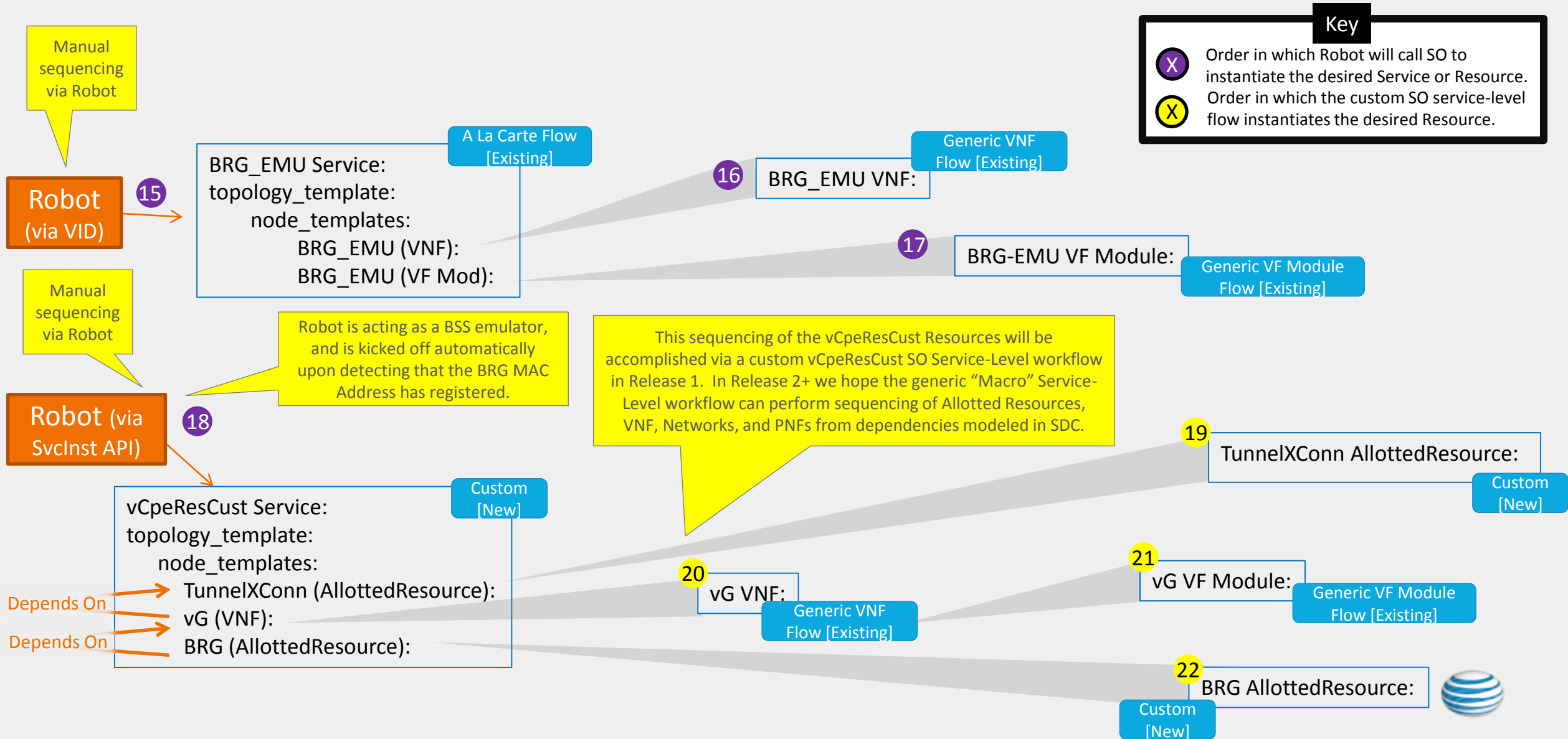

Residential Broadband vCPE Use Case Model: BRG_EMU and vCpeGenInfra Inventory Instance Example

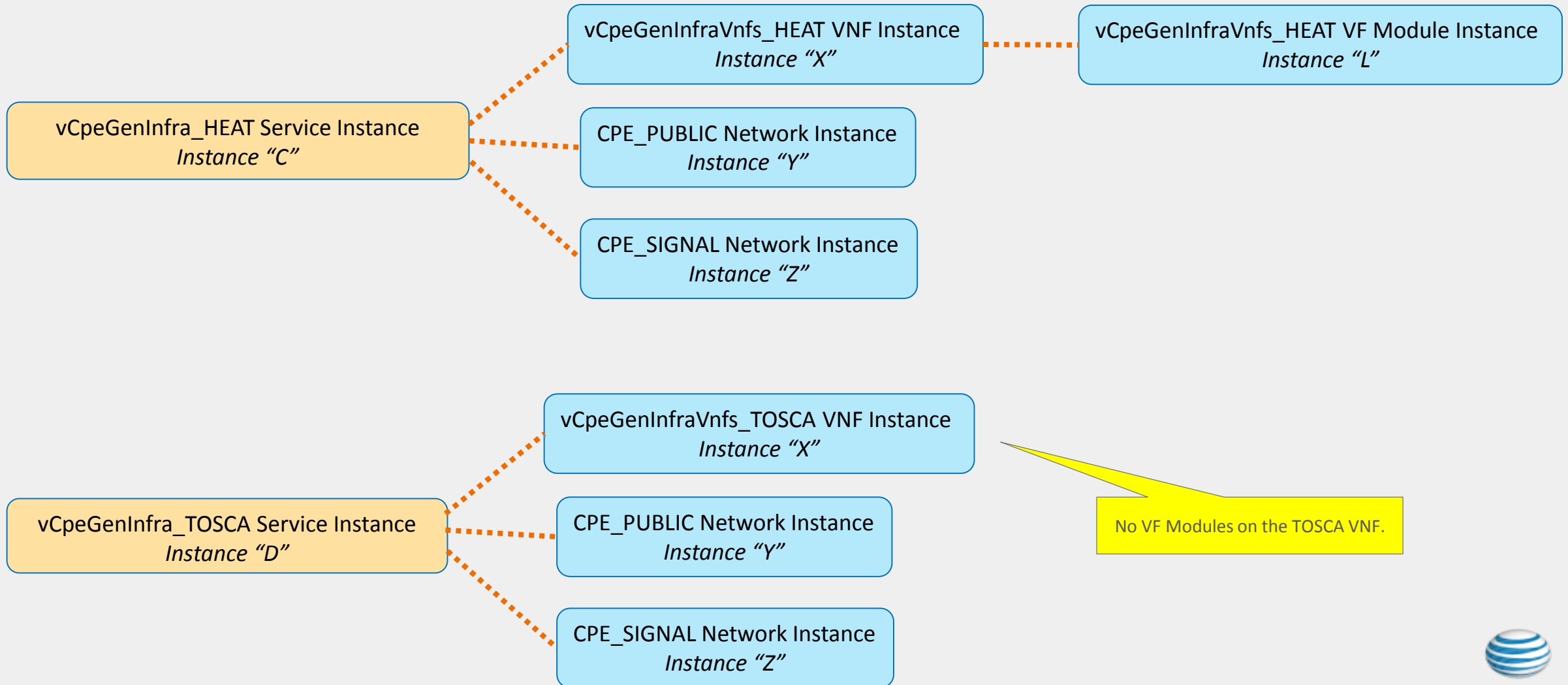

Residential Broadband vCPE Use Case Model: vCpeResCust & vGMuxInfra Topology

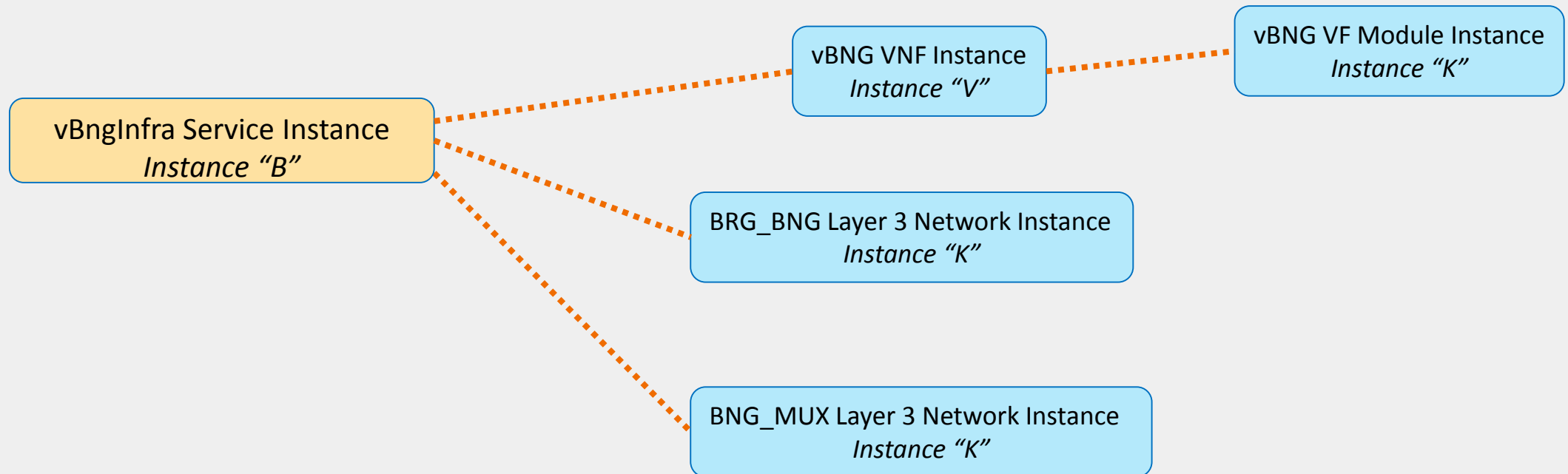

Residential Broadband vCPE Use Case Model: BRG_EMU and vCpeGenInfra Inventory Instance Example

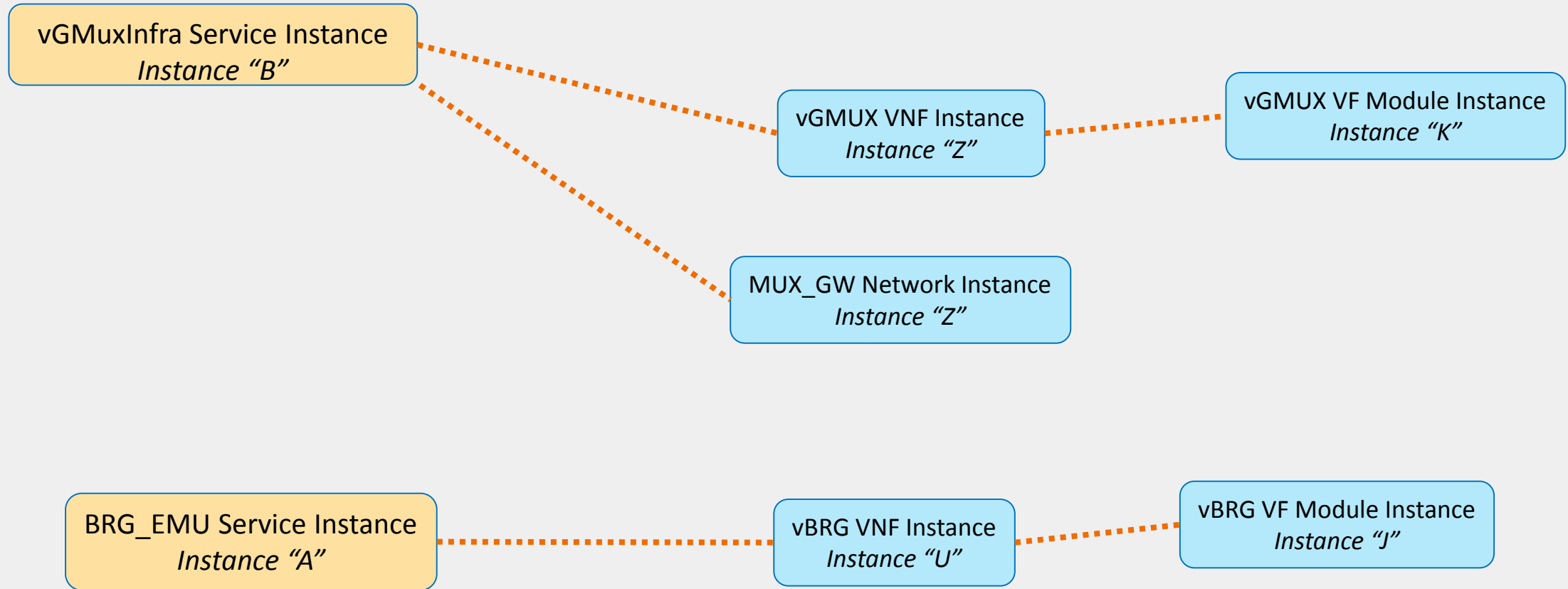

Residential Broadband vCPE Use Case Model: vCpeResCust & vGMuxInfra Inventory Instance Example

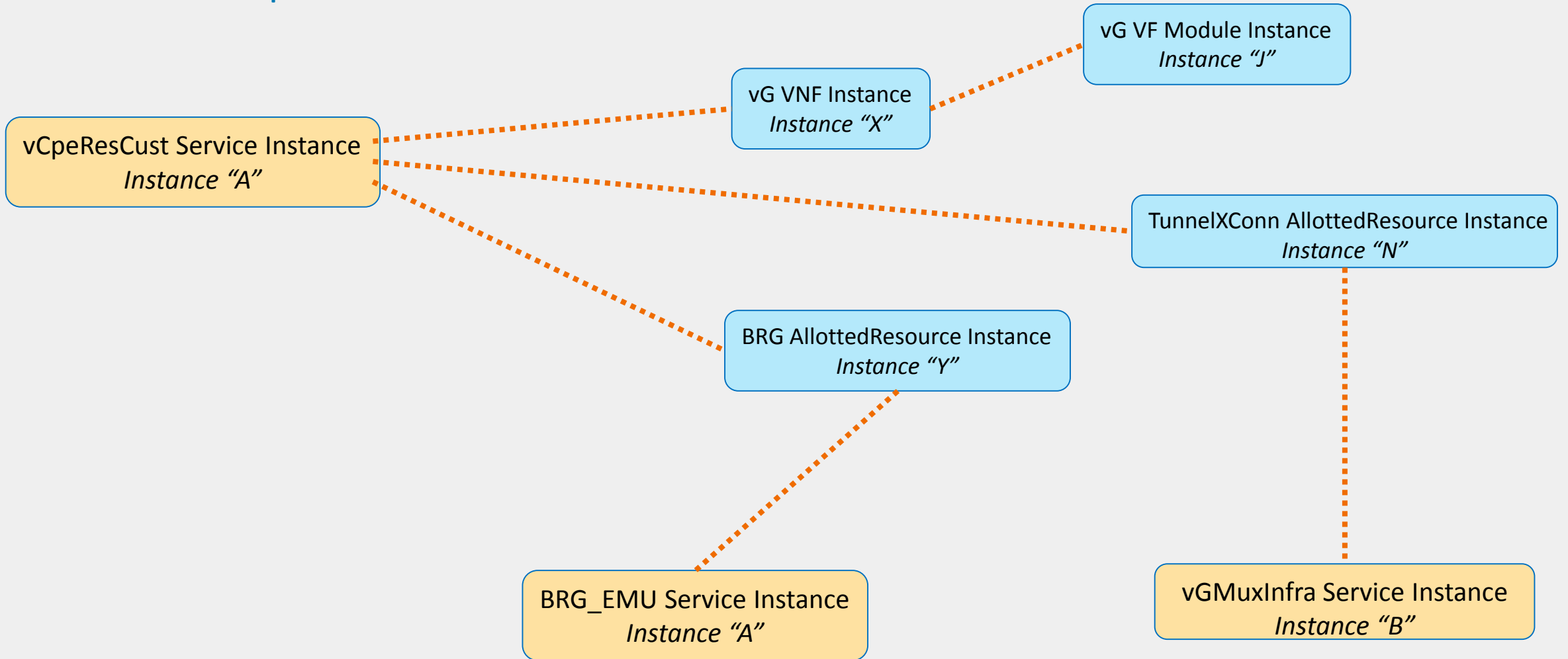

A&AI Detail Example

The Cloud Region object in A&AI is created via the ESR (A&AI) portal

- User inputs backend Cloud information into ESR portal
- ESR stores the backend Cloud information as auth model into AAI, key is `cloudowner_cloudregion`
- User triggers VIM register service exposed by Multi VIM which will trigger registry implements in different VIM plugins to fill in VIM Model information into AAI
- Each plugin handles AAI query about the backend Cloud information for backend Cloud operations

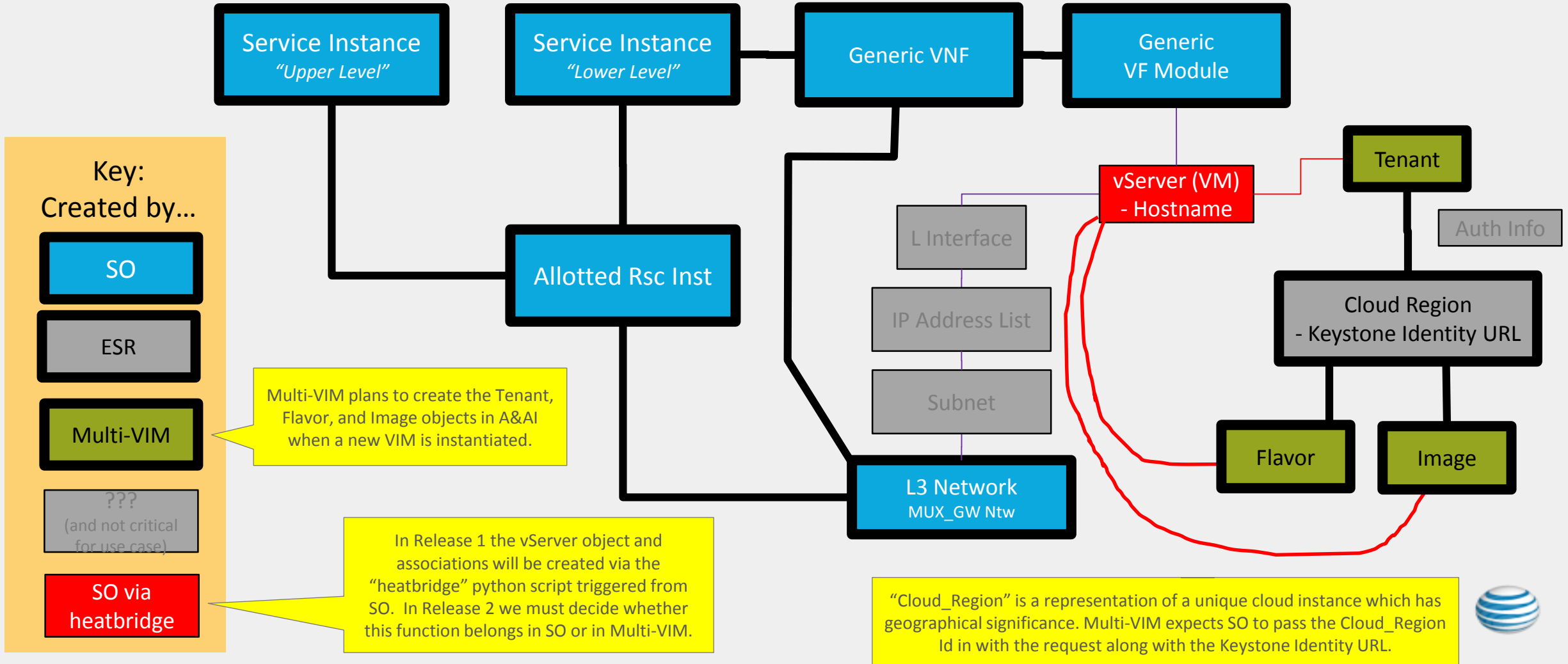



Order in which Robot will call SO to instantiate the desired Service or Resource.

Residential Broadband vCPE Use Case Overview

Service	Resource	SO Flow	SDNC Northbound API	SDNC DG	SDNC Inputs	SDNC Assignments	Pre-Load?	SDNC Configuration
1 vCpeGenInfra_X		CrGenSvcInstance (A La Carte) -> DoCreateServiceInstance	N/A	N/A	N/A	N/A	N/A	N/A
"	1a CPE_PUBLIC (Network)	CreateNetworkInfra (A La Carte) -> DoCreateNetwork	VNF-API	Generic DG	NULL Set	cpe_public_net_cidr, cpe_public_net_id	Yes	NULL Set
"	1b CPE_SIGNAL (Network)	CreateNetworkInfra (A La Carte) -> DoCreateNetwork	VNF-API	Generic DG	NULL Set	cpe_signal_net_cidr, cpe_signal_net_id	Yes	NULL Set
"	1c vCpeGenInfraVnfs_HEAT (VNF)	CreateVnfInfra (A La Carte) -> DoCreateVnf	N/A	N/A	N/A	N/A	N/A	N/A
"	1d vCpeGenInfraVnfs_X (VF Module)	CrVfModuleInfra (A La Carte) -> DoCreateVfMod	VNF-API	Generic DG	NULL Set	cpe_public_net_id, cpe_signal_net_id, onap_private_net_id, vdhcp_name_0, vaaa_name_0, vdns_name_0, vweb_name_0, vdns_private_ip_0 (cpe_public), vdns_private_ip_1 (onap_private), vweb_private_ip_0 (cpe_public), vweb_private_ip_1 (onap_private), vdhcp_private_ip_0 (cpe_signal), vdhcp_private_ip_1 (onap_private), vaaa_private_ip_0 (cpe_signal), vaaa_private_ip_1 (onap_private), Etc..... (see HEAT)	Yes	NULL Set

We would have preferred to have used the SO “generic service-level” flow, which, triggered by a Service-Level instantiation request from Robot for a given Service (e.g., vCpeGenInfra_X), would automatically decompose it into its component Resources, and orchestrate instantiation of the same. However, in Release 1 we used “pre-load” assignments, which currently isn’t a supported option for this “generic service” approach. In R2 we would like to extend this use case to leverage dynamic resource assignment along with this “generic service” approach to demonstrate model-driven service-level automation for the vCpeGenInfra_X, vBngInfra, vGMuxInfra and BRG_EMU Services.





Order in which Robot will call SO to instantiate the desired Service or Resource.

Residential Broadband vCPE Use Case Overview

Service	Resource	SO Flow	SDNC Northbound API	SDNC DG	SDNC Inputs	SDNC Assignments	Pre-Load?	SDNC Configuration
2 vBngInfra		CrGenSvcInstance (A La Carte) -> DoCreateServiceInstance	N/A	N/A	N/A	N/A	N/A	N/A
"	2a BRG_BNG (Network)	CreateNetworkInfra (A La Carte) -> DoCreateNetwork	VNF-API	Generic DG	NULL Set	brgemu_bng_private_net_cidr, brgemu_bng_private_net_id	Yes	NULL Set
"	2b BNG_MUX (Network)	CreateNetworkInfra (A La Carte) -> DoCreateNetwork	VNF-API	Generic DG	NULL Set	bng_gmux_private_net_cidr, bng_gmux_private_net_id	Yes	NULL Set
"	2c vBNG (VNF)	CreateVnfInfra (A La Carte) -> DoCreateVnf	N/A	N/A	N/A	N/A	N/A	N/A
"	2d vBNG (VF Module)	CrVfModuleInfra (A La Carte) -> DoCreateVfMod	VNF-API	Generic DG	NULL Set	cpe_signal_net_id, bng_gmux_private_net_id, brgemu_bng_private_net_id, onap_private_net_id, vbng_name_0, vbng_private_ip_0 (brgemu_bng), vbng_private_ip_1 (onap_private), vbng_private_ip_2 (cpe_signal), vbng_private_ip_3 (bng_gmux), Etc....	Yes	NULL Set
3 vGMuxInfra		CrGenSvcInstance (A La Carte) -> DoCreateServiceInstance	N/A	N/A	N/A	N/A	N/A	N/A
"	3a MUX_GW (Network)	CreateNetworkInfra (A La Carte) -> DoCreateNetwork	VNF-API	Generic DG	NULL Set	mux_gw_private_net_cidr, bng_gmux_private_net_id	Yes	NULL Set
"	3b vGMUX (VNF)	CreateVnfInfra (A La Carte) -> DoCreateVnf	N/A	N/A	N/A	N/A	N/A	N/A
"	3c vGMUX (VF Module)	CrVfModuleInfra (A La Carte) -> DoCreateVfMod	VNF-API	Generic DG	NULL Set	bng_gmux_private_net_id, mux_gw_private_net_id, onap_private_net_id, VNI_POOL, vgmux_name_0, vgmux_private_ip_0 (bng_gmux), vgmux_private_ip_1 (onap_private), vgmux_private_ip_2 (mux_gw), Etc...	Yes	NULL Set

Residential Broadband vCPE Use Case Overview

Key

 Order in which Robot will call SO to instantiate the desired Service or Resource.

 Order in which the custom SO service-level flow instantiates the desired Resource.

Service	Resource	SO Flow	SDNC Northbound API	SDNC DG	SDNC Inputs	SDNC Assignments	Pre-Load?	SDNC Configuration
4 BRG_EMU		CrGenSvcInstance (A La Carte) -> DoCreateServiceInstance	N/A	N/A	N/A	N/A	N/A	N/A
" 4a	BRG_EMU (VNF)	CreateVnfInfra (A La Carte) -> DoCreateVnf	N/A	N/A	N/A	N/A	N/A	N/A
" 4b	BRG_EMU (VF Module)	CrVfModuleInfra (A La Carte) -> DoCreateVfMod	VNF-API	Generic DG	NULL Set	vbrgemu_bng_private_net_id, vbrgemu_name_0, Etc...	N/A	NULL Set
"	BRG_EMU (VNF) [Event Handling]	N/A	N/A	Custom Process [Event Handling; New]	N/A	N/A	N/A	N/A
5 vCpeResCust		Custom_vCpeResCust	GENERIC-RESOURCE	Generic DG	NULL Set	NULL Set	N/A	NULL Set
" 5a	TunnelXConn (AR)	Custom_vCpeResCust -> Custom_TunnelXConn	GENERIC-RESOURCE	Custom Sub-DG [New]	[On "Assign"] BRG_WAN_MAC_Address	VNI, vgmux_private_ip_2 (mux_gw), vgmux_private_ip_0 (bng_gmux) vgw_private_ip_0 (mux_gw)	Yes	[On "Create"] Xconn: {vbrgemu_private_ip_0, VNI, vgw_private_ip_0 }
" 5b	vG (VNF)	Custom_vCpeResCust -> DoCreateVnfAndModule -> DoCreateVnf	GENERIC-RESOURCE	Generic DG	[On "Assign"] VNI, vgmux_private_ip_2 (mux_gw)	cpe_public_net_id, mux_gw_private_net_id, onap_private_net_id, Etc...	No	NULL Set
" 5c	vG (VF Module)	Custom_vCpeResCust -> DoCreateVnfAndModule -> DoCreateVfMod	GENERIC-RESOURCE	Custom Sub-DG [New]	NULL Set	vgw_private_ip_1 (onap_private), vgw_name_0, Etc...	Yes	[On "Activate"] vgw_private_ip_0 (mux_gw), VNI, vgmux_private_ip_2 (mux_gw)
" 5d	BRG (AR)	Custom_vCpeResCust -> Custom_BRG	GENERIC-RESOURCE	Custom Sub-DG [New]	[On "Assign"] vgmux_private_ip_0 (bng_gmux), VNI, BRG_WAN_MAC_Address	NULL Set	N/A	[On "Activate"] BRG_BRG_BNG_IP, VNI, VGMUX_BNG_MUX_IP

Residential Broadband vCpeGenInfra_X Data

Service Level

1 vCpeGenInfra_X Service: A La Carte Flow [Existing]

topology_template:
node_templates:
 cpe_public_net (Network)
 cpe_signal_net (Network)
 vCpeGenInfraVnfs_X (VNF)
 vCpeGenInfraVnfs _HEAT (VF Mod)

SO Input Attributes:
{NULL Set}

As part of the Network-level "Assign" operation, SDNC assigns the network name and the "10.4" subnet to this network instance.

In Release 2, using the generic "Macro" Service-level flow and the "Generic-Resource" SDNC API, a separate "assign" call will be made at the VNF level which will result in SDNC assigning each of the "external connection point" (*_NET_ID) values.

Resource Level

2 CPE_PUBLIC Network:
SO Input Attributes:
{NULL Set}
SDNC Assigned Attributes:
 cpe_public_net_cidr,
 cpe_public_net_id

As part of the Network-level "Assign" operation, SDNC assigns the network name and the "10.2" subnet to this network instance.

3 CPE_SIGNAL Network:
SO Input Attributes:
{NULL Set}
SDNC Assigned Attributes:
 cpe_signal_net_cidr,
 cpe_signal_net_id

4 vCpeGenInfraVnfs_X VNF:
SO Input Attributes:
{NULL Set}
SDNC Assigned Attributes:
{NULL Set}
SDNC Configured Attributes:
{NULL Set}

As part of the VF Module-level "Assign" operation, SDNC determines that this VNF must connect to three network types. It also assigns the VM Names and the IPs for the relevant VMs each of the networks

VF Module Level (HEAT+TOSCA)

5 vCpeGenInfraVnfs _HEAT VF Module:
SO Input Attributes:
{NULL Set}
SDNC Assigned Attributes:
 cpe_public_net_id,
 cpe_signal_net_id,
 onap_private_net_id,
 vdhcp_name_0, vaaa_name_0,
 vdns_name_0, vweb_name_0,
 vdns_private_ip_0 (cpe_public),
 vdns_private_ip_1 (onap_private),
 vweb_private_ip_0 (cpe_public),
 vweb_private_ip_1 (onap_private),
 vdhcp_private_ip_0 (cpe_signal),
 vdhcp_private_ip_1 (onap_private),
 vaaa_private_ip_0 (cpe_signal),
 vaaa_private_ip_1 (onap_private),
 Etc... (see HEAT)



Residential Broadband vCPE Use Case Model: vBNG Service Data Mappings

Service Level

6
vBngInfra Service:
topology_template:
node_templates:
vBNG:
BRG_BNG
SO Input parameters:
{NULL Set}

A La Carte Flow
[Existing]

As part of the Network-level "Assign" operation, SDNC assigns the "10.3" subnet to this network instance.

In Release 2, using the generic "Macro" Service-level flow and the "Generic-Resource" SDNC API, a separate "assign" call will be made at the VNF level which will result in SDNC assigning each of the "external connection point" (*_NET_ID) values.

Resource Level

7
BNG_MUX Network:
SO Input Attributes:
{NULL Set}
SDNC Assigned Attributes:
bng_gmux_private_net_cidr,
bng_gmux_private_net_id

As part of the Network-level "Assign" operation, SDNC assigns the network name and the "10.1" subnet to this network instance.

8
BRG_BNG Network:
SO Input Attributes:
{NULL Set}
SDNC Assigned Attributes:
brgemu_bng_private_net_cidr,
brgemu_bng_private_net_id

As part of the VF Module-level "Assign" operation, SDNC determines that the vBNG must connect to four network types and assigns the network names for each. It also assigns the IPs "10.4.0.3", "10.1.0.10", "10.3.0.1", and "10.0.101.10" to these networks, respectively.

9
vBNG VNF:
SO Input Attributes:
{NULL Set}
SDNC Assigned Attributes:
{NULL Set}
SDNC Configured Attributes:
{NULL SET}

10
vBNG VF Module:
SO Input Attributes:
{NULL Set}
SDNC Assigned Attributes:
cpe_signal_net_id,
bng_gmux_private_net_id,
brgemu_bng_private_net_id,
onap_private_net_id,
vbng_name_0,
vbng_private_ip_0 (brgemu_bng),
vbng_private_ip_1 (onap_private),
vbng_private_ip_2 (cpe_signal),
vbng_private_ip_3 (bng_gmux)



Residential Broadband vCPE Use Case Model: vGMuxInfra Service Data Mappings

Resource Level

VF Module Level

Service Level

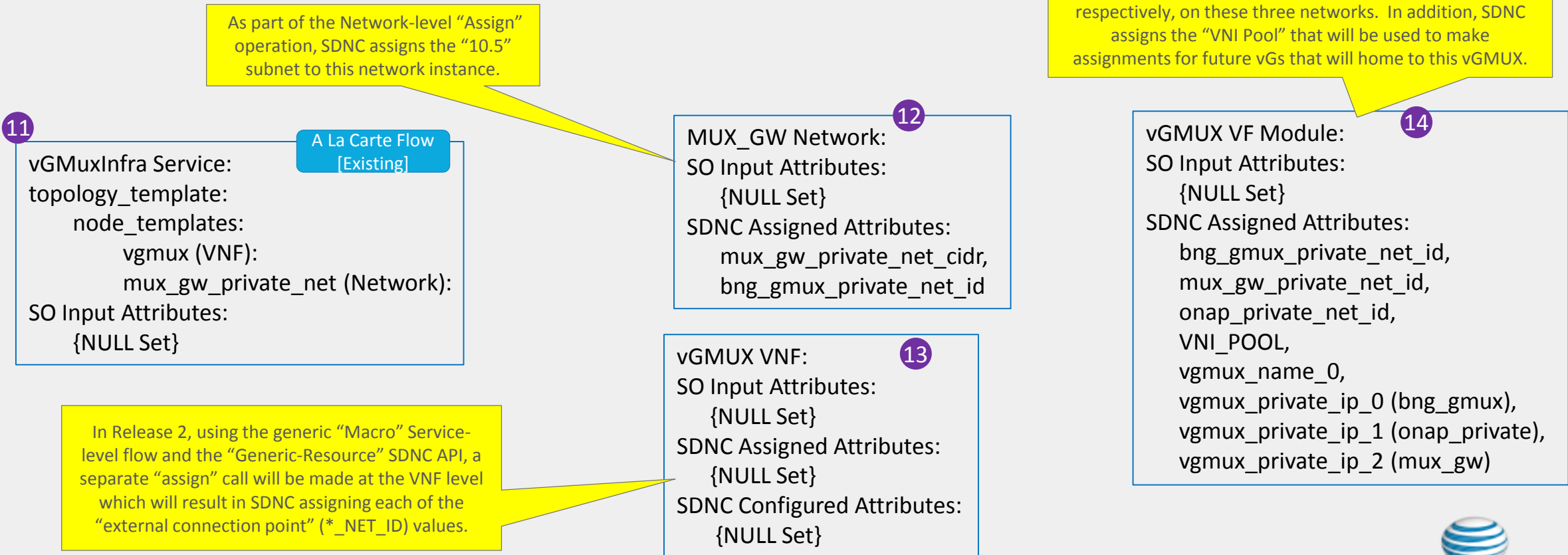

Residential Broadband vCPE Use Case Model: BRG_EMU Service Data Mappings

In Release 2, we hope to leverage the generic "Macro" Service-level flow and the "Generic-Resource" SDNC API. This "Macro" flow will orchestrate the VNF and VF Module Service-Level Resources. At that time, the BRG_WAN_MAC_Address would be entered as SO Input at the Service-level, and the Macro flow itself would pass to the VNF level and on to the VF level flow where it is actually needed for the HEAT construction.

The BRG_WAN_MAC_Address is communicated via the BRG HEAT.

Service Level

- 15 BRG_EMU Service:
 - topology_template:
 - node_templates:
 - vbrg_emu (VNF):
 - SO Input Attributes:
 - {NULL SET}

A La Carte Flow
[Existing]

VF Module Level

- 17 vBRG_EMU VF Module:
 - SO Input Attributes:
 - BRG_WAN_MAC_Address
 - SDNC Assigned Attributes:
 - vbrgemu_bng_private_net_id,
 - vbrgemu_name_0

Resource Level

- 16 vBRG_EMU VNF:
 - SO Input Attributes:
 - {NULL SET}
 - SDNC Assigned Attributes:
 - {NULL SET}
 - SDNC Configured Attributes:
 - {NULL SET}

In Release 2, using the generic "Macro" Service-level flow and the "Generic-Resource" SDNC API, a separate "assign" call will be made at the VNF level which will result in SDNC assigning each of the "external connection point" (*_NET_ID) values.



Residential Broadband vCPE Use Case Model: vCpeResCust Input Data Mappings (R1)

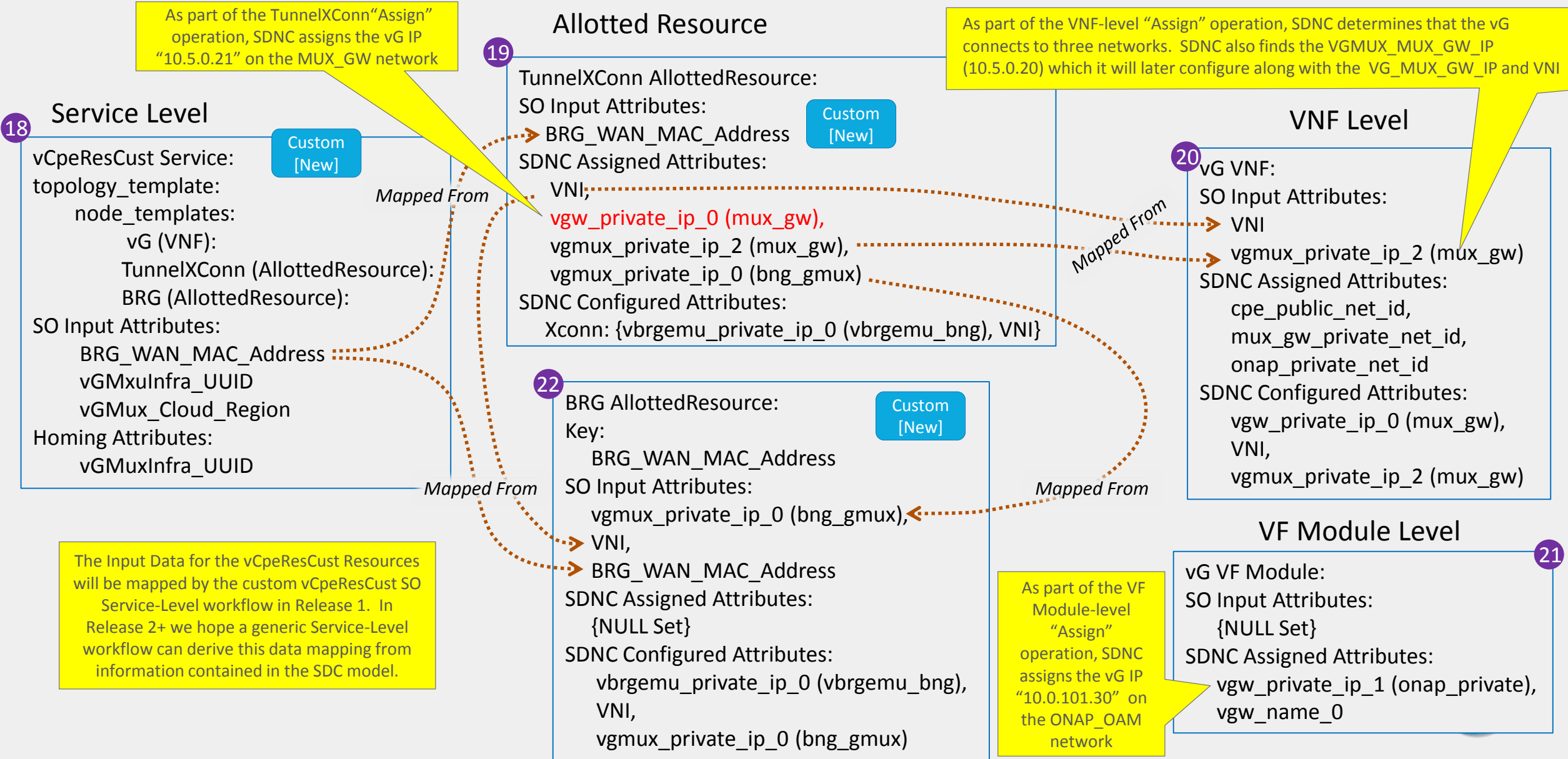

Generic Service Level Processing ("Macro")

CreateGenericMacroServiceNetworkVnf
-> DoCreateServiceInstance



onap_uc_Generic_Service.html

Generic Service Instantiation Flow

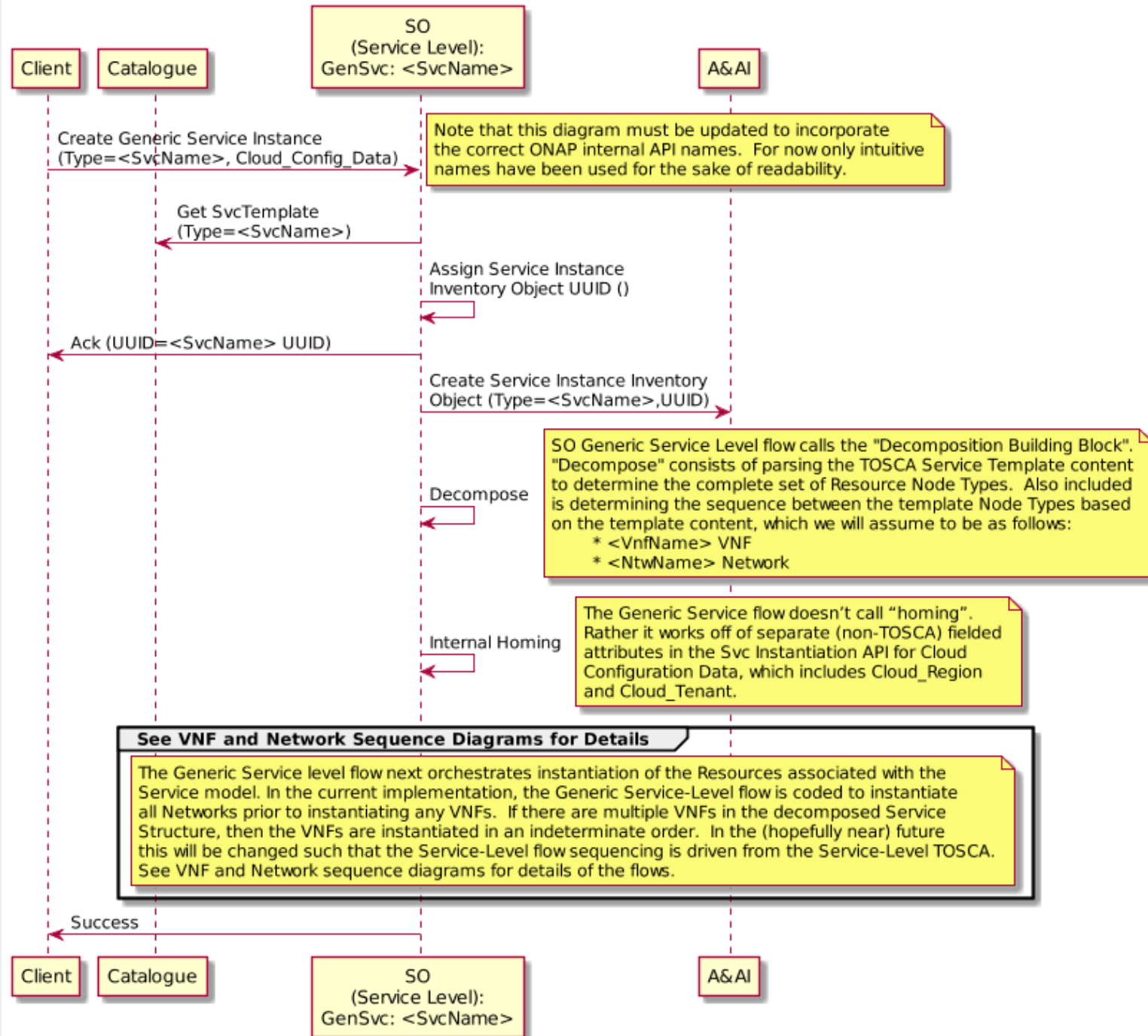

Generic
Resource Level Processing:
Networks ("Macro")

CreateGenericMacroServiceNetworkVnf
-> DoCreateNetworkInstance



onap_uc_Generic_Resource_Ntw.html

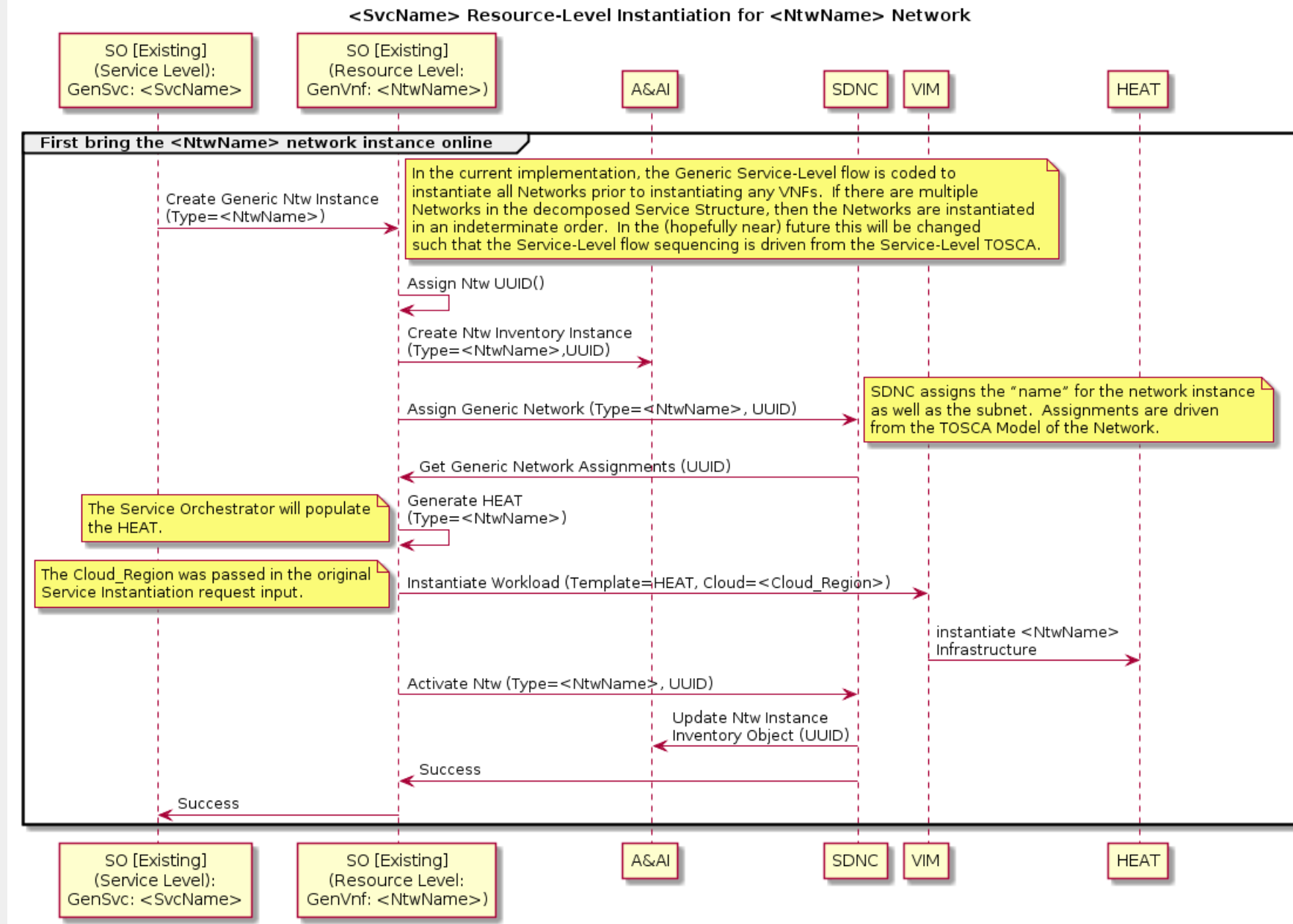

Generic Resource Level Processing: VNFs ("Macro")

CreateGenericMacroServiceNetworkVnf

-> DoCreateVnfAndModules

-> DoCreateVnf

-> DoCreateVfModule



onap_uc_Generic_Resource_VNF.html

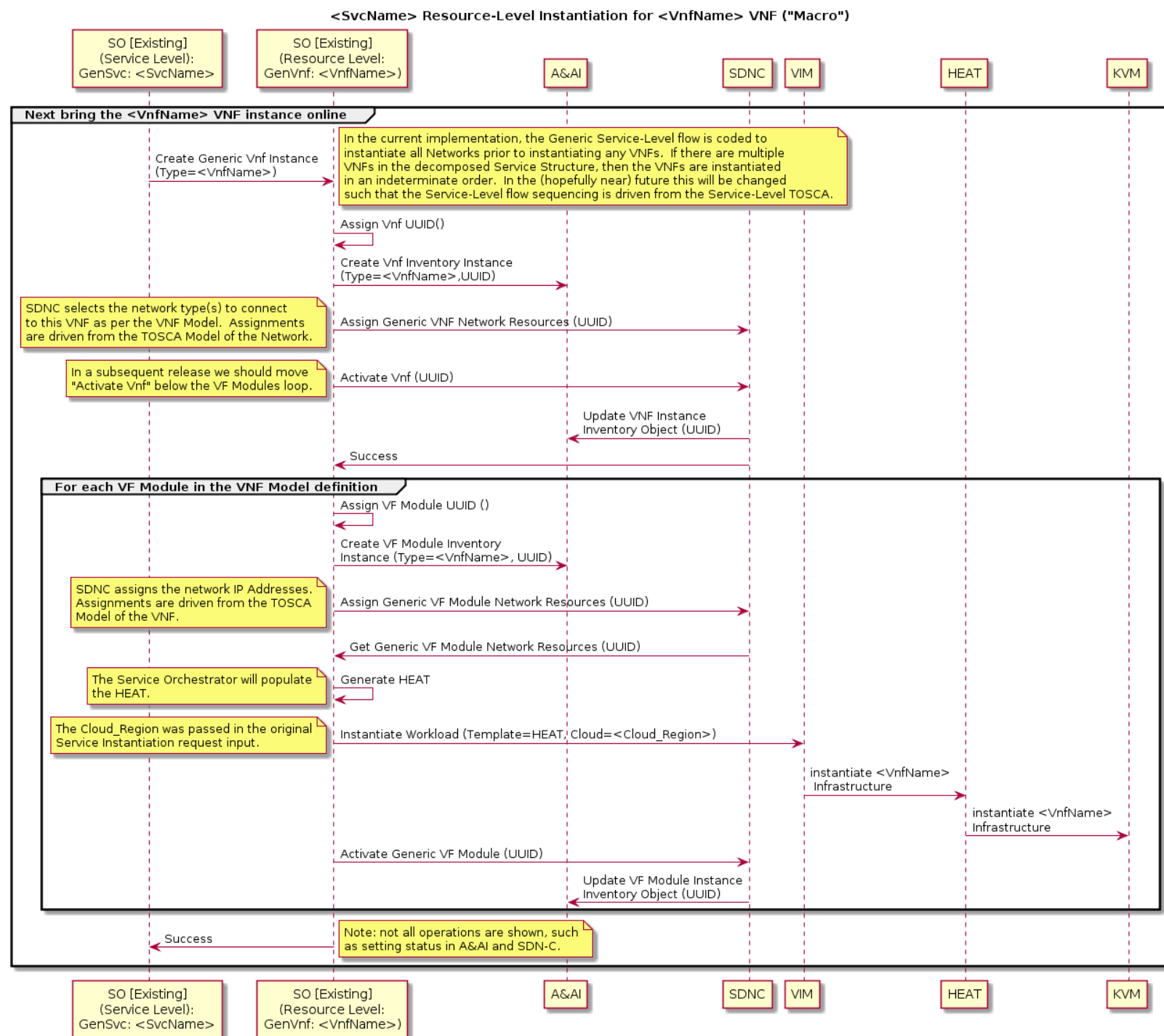

Generic

Resource Level Processing: Services ("A La Carte")

CreateGenericALaCarteServiceInstance



onap_uc_Generic_Resource_Service_ALaCarte.html

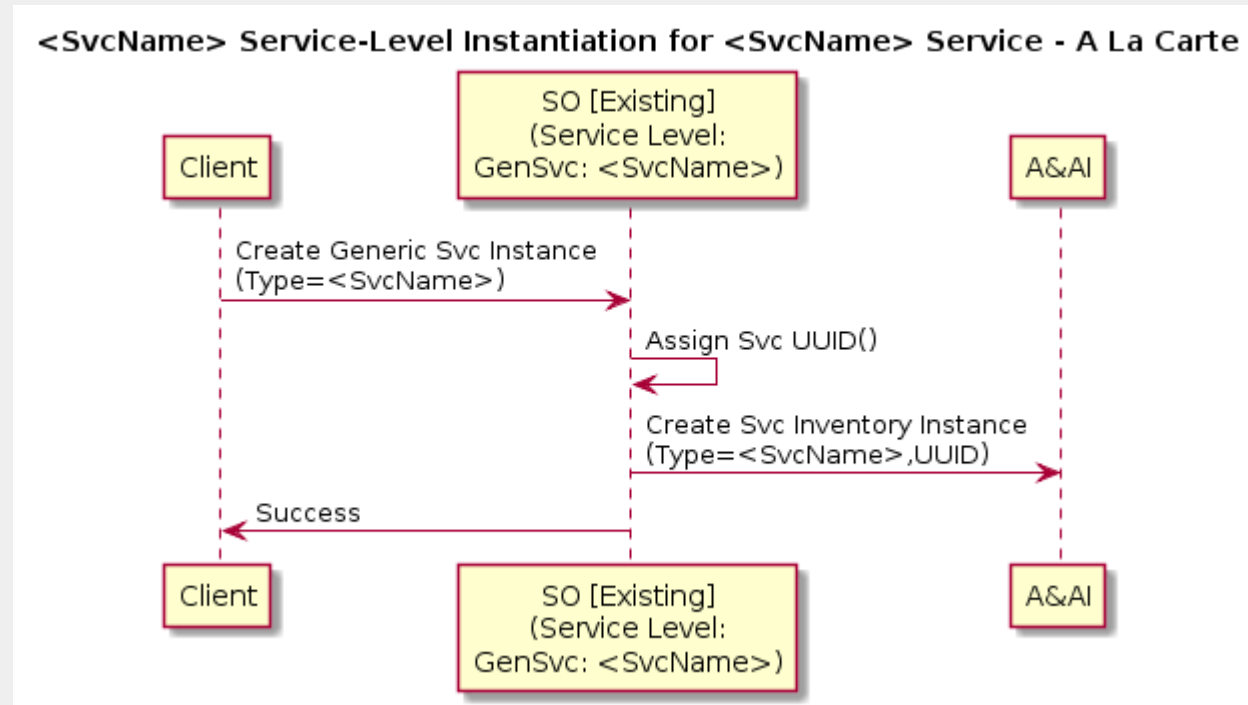

Generic
Resource Level
Processing:
Network
("A La Carte")

<SvcName> Resource-Level Instantiation for <NtwName> Network - A La Carte

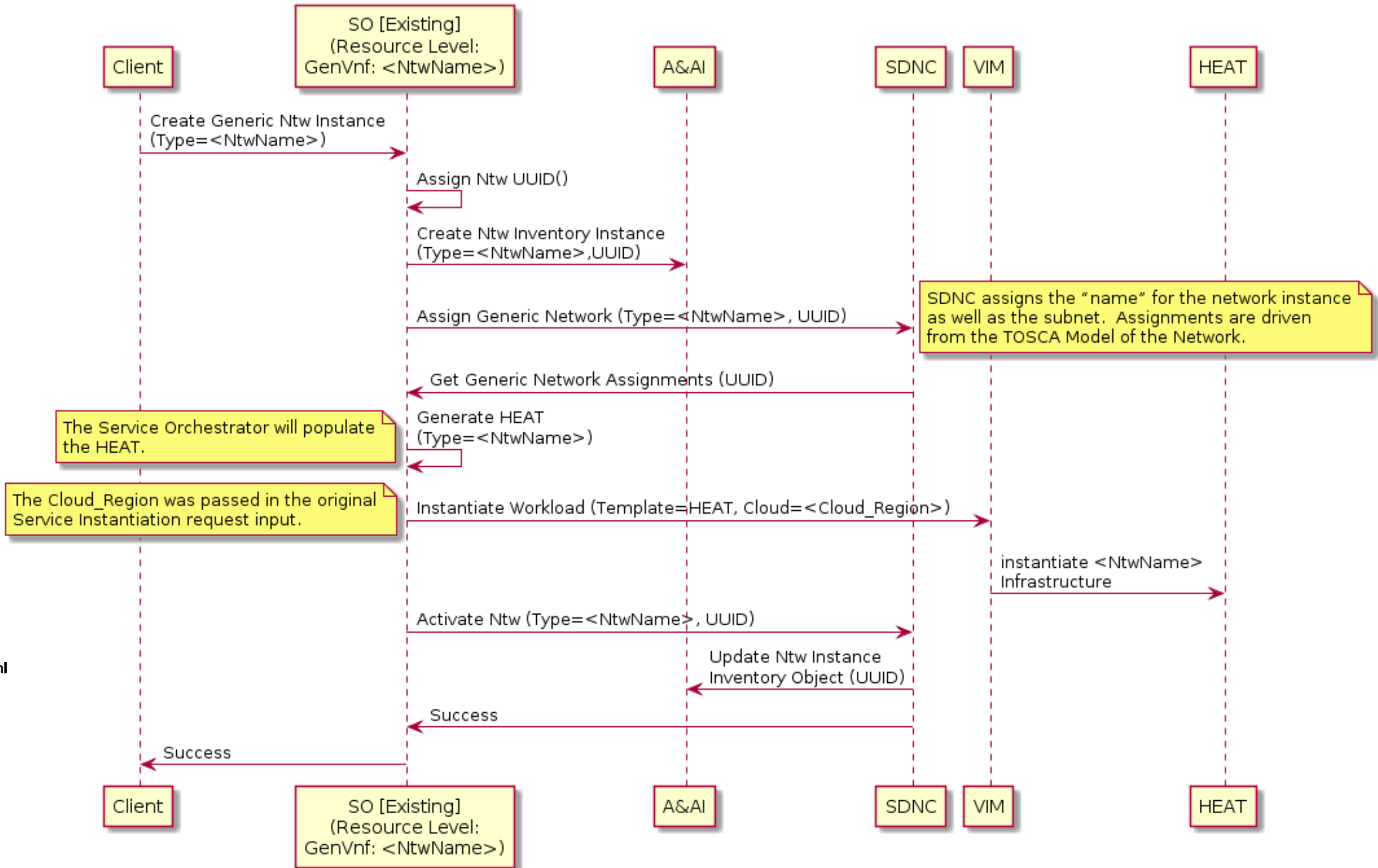

Generic
Resource Level
Processing:
VNFs (“A La Carte”)

CreateVnfInfra



onap_uc_Generic_Resource_VNF_ALaCarte.html

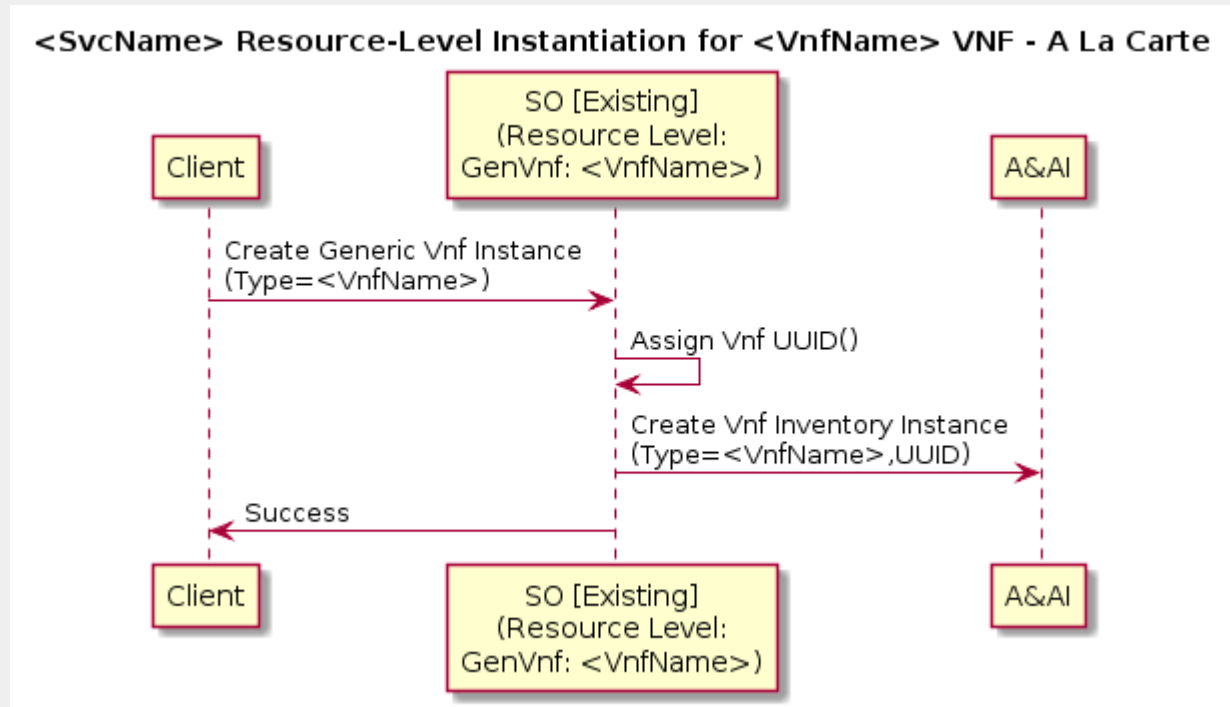

Generic Resource Level Processing: VF Module ("A La Carte")

CreateVfModuleInfra



onap_uc_Generic_Resource_VF_Module_ALaCarte.html

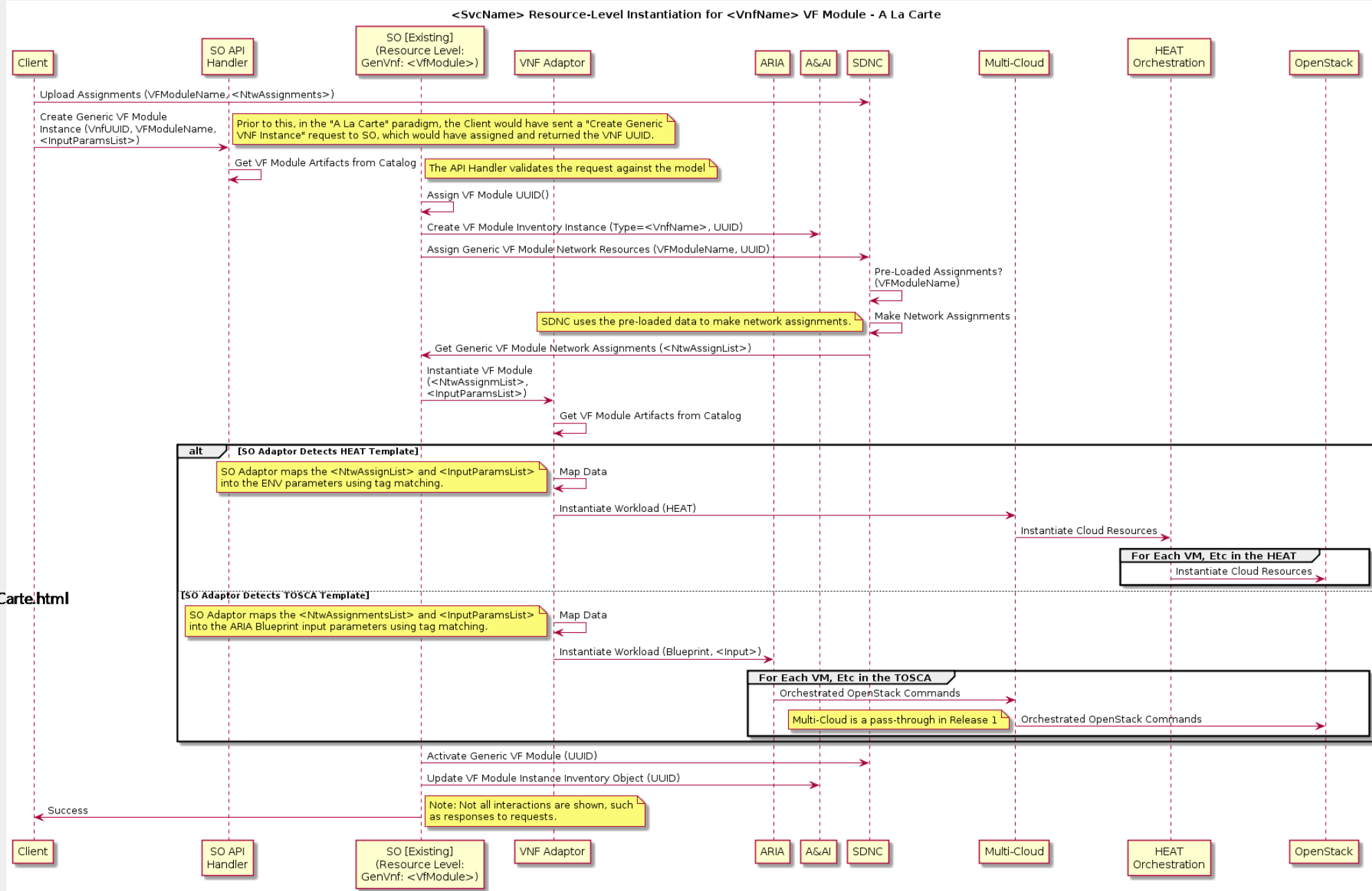

Assumptions

Once the BRG_EMU VNF Controller configures the vBRG_EMU VNF (see prior slide), that VNF will initiate DHCP interactions. This will result in an event being generated, which will be intercepted by the BRG Allotted Resource Controller. Note that the BRG_EMU VNF Controller shown in the prior sequence diagram is a *different* Controller function, and hence may be a different Controller instance, than the BRG Allotted Resource Controller which receives this event.

Being independent of each other, the vCpeResCust service instantiation request may be received in ONAP before the BRG Allotted Resource Controller receives this event notification, or it may be received after. The following sequence diagrams show both possibilities. However, in Release 1, only the latter will be supported.



BRG_EMU Event Processing (Custom)



onap_uc_res_vcpe_r1_brg_event.html

BRG_EMU Event Processing

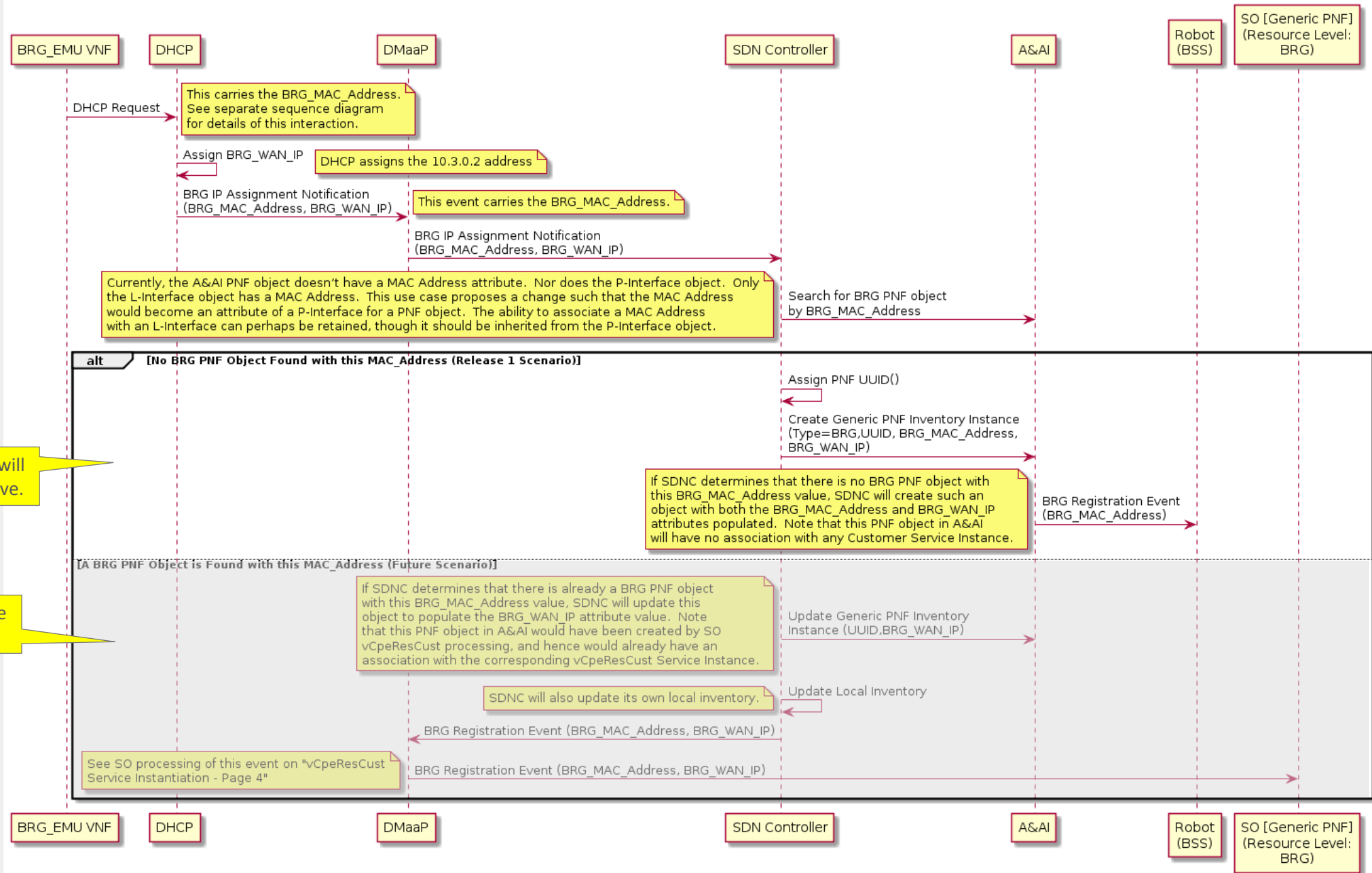

In Release 1 Use Case we will support only this alternative.

We will defer this alternative until Release 2 or beyond.

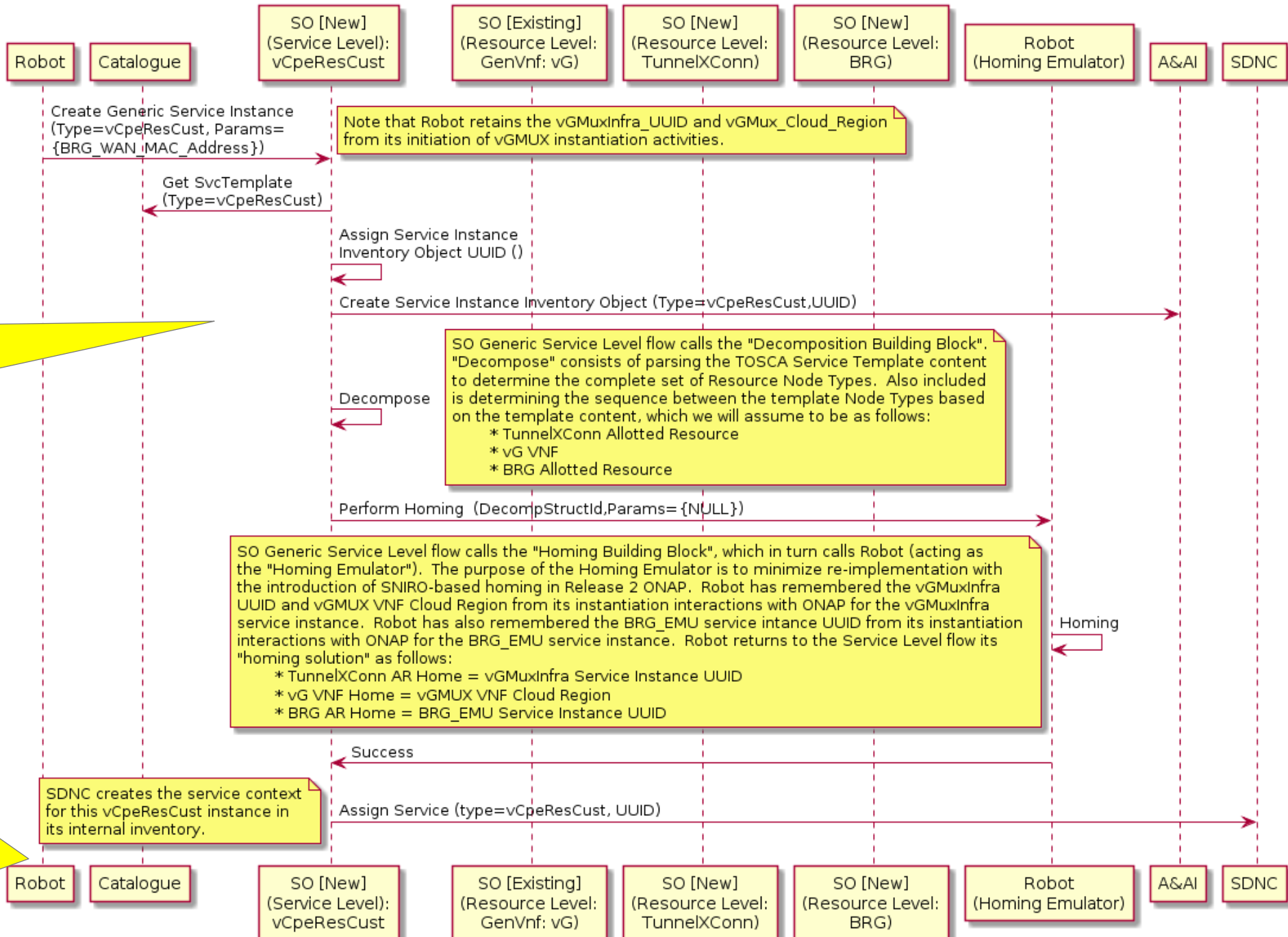

vCpeResCust Service Level Processing (Custom)

Because the vCpeResCust service involves an Allotted Resource, the generic Service Level ("top level") SO flow will not support this Service. So in Release 1 we either needed to extend the generic Service Level flow to support Allotted Resources or build a Custom flow for vCpeResCust.



onap_uc_res_vcpe_r1_p1.html

Next the vCpeResCust Service Level custom flow will call the associated Resource level flows in the proper order (see slide 19):

- TunnelXConn Allotted Resource (assigned, created, and configured)
- vG VNF + VF Module (assigned, instantiated, and configured)
- BRG Allotted Resource (assigned, created, and configured)

vCpeResCust Resource Level Processing:

- TunnelXConn Allotted Resource (Custom)



onap_uc_res_vcpe_r1_p2.html

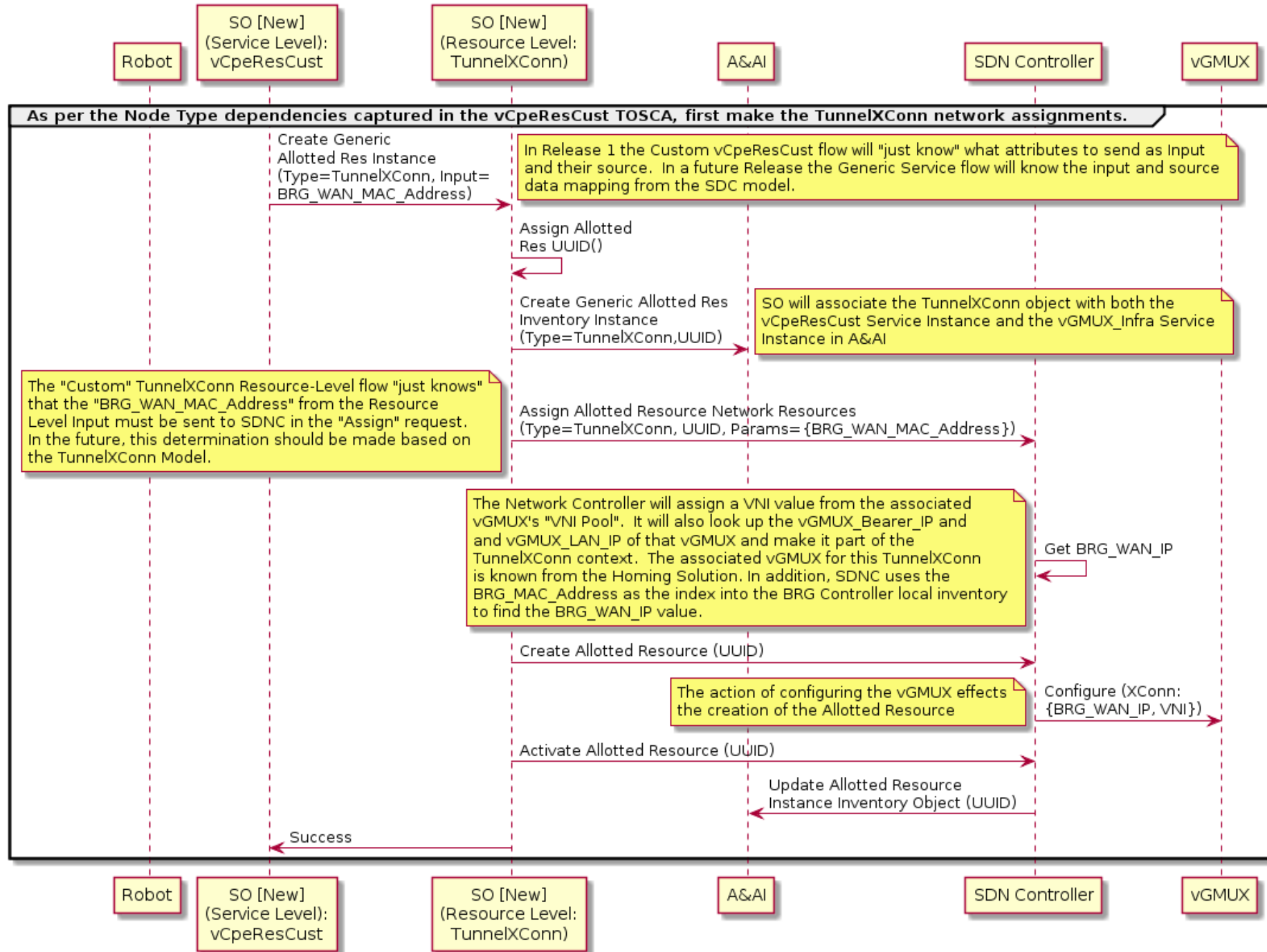

vCpeResCust Resource Level

Processing:

- vG (Generic SO, Custom DG)

The vG VNF leverages the Generic Resource Level Processing: VNFs (“Macro”) flow shown on slide 28, with one exception. Rather than using the “Generic DG” SDNC behavior which is shown on slide 28, SDNC will have a “Custom DG” for the vG VF Module-level processing. This DG will use the VF Module-Level activation as the trigger to configure the vG, as shown in the diagram to the right.

This is because it was lately determined that the MSO Macro flow (as described on slide 28) requests the “VNF Activate” prior to starting the VF Module-level loop, which is a poor implementation given the VM hasn’t even been instantiated yet at the point in the flow when this “VNF Activate” occurs. The “correct” implementation would be to move this “VNF Activate” request after the VF Module loop. However, until this can be done, it was decided to use the “Custom DG” solution described above.



onap_uc_res_vcpe_vG_r1.html

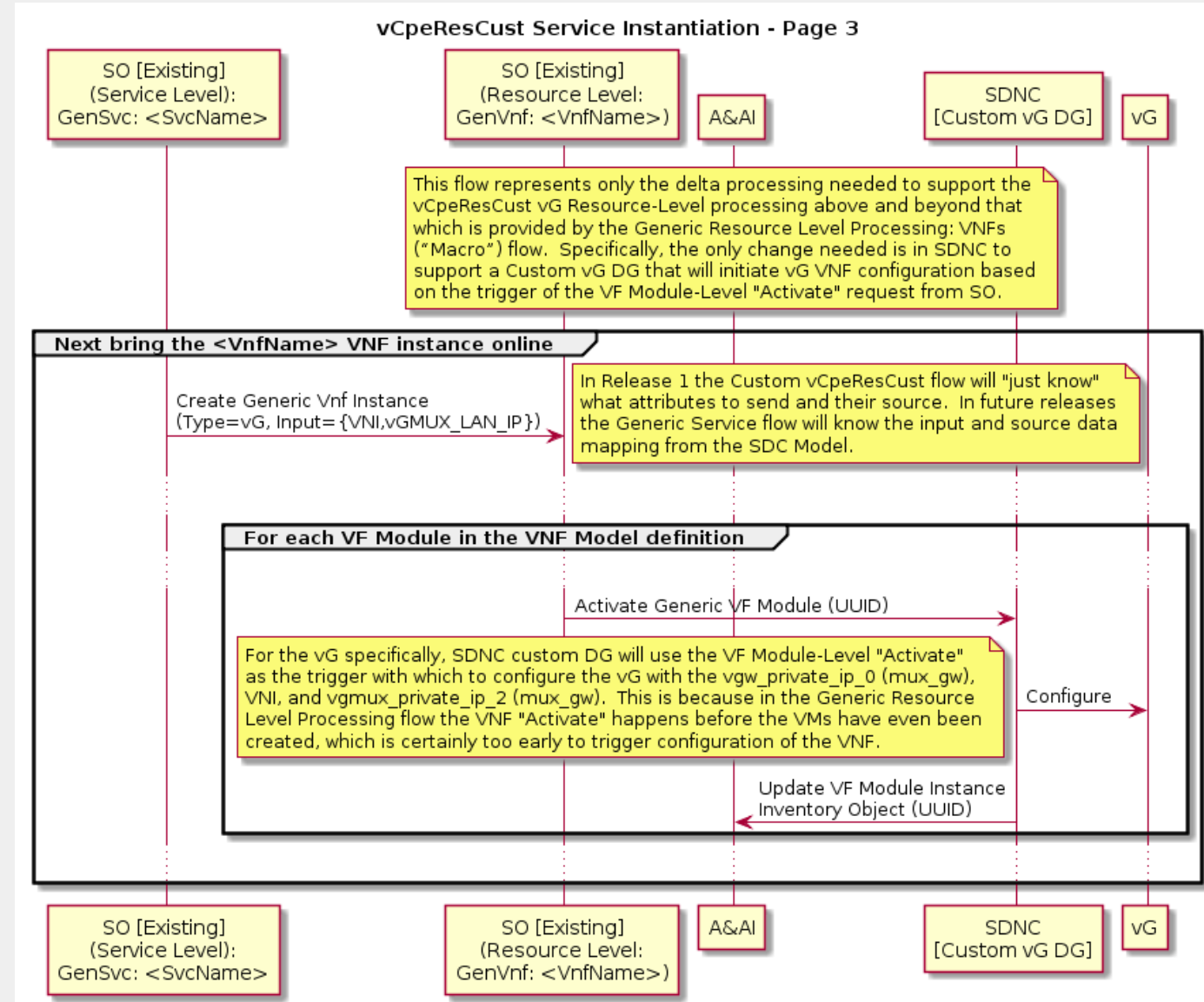

vCpeResCust Resource Level Processing:

- BRG Allotted Resource (Custom)



onap_uc_res_vcpe_r1_p4.html

Future:

- Add step to get monitoring in place at the Service and Resource level (via REST call)
- Add step to get Security in place
- Add step to notify turn up to Ops; need to define a REST call to an external system.

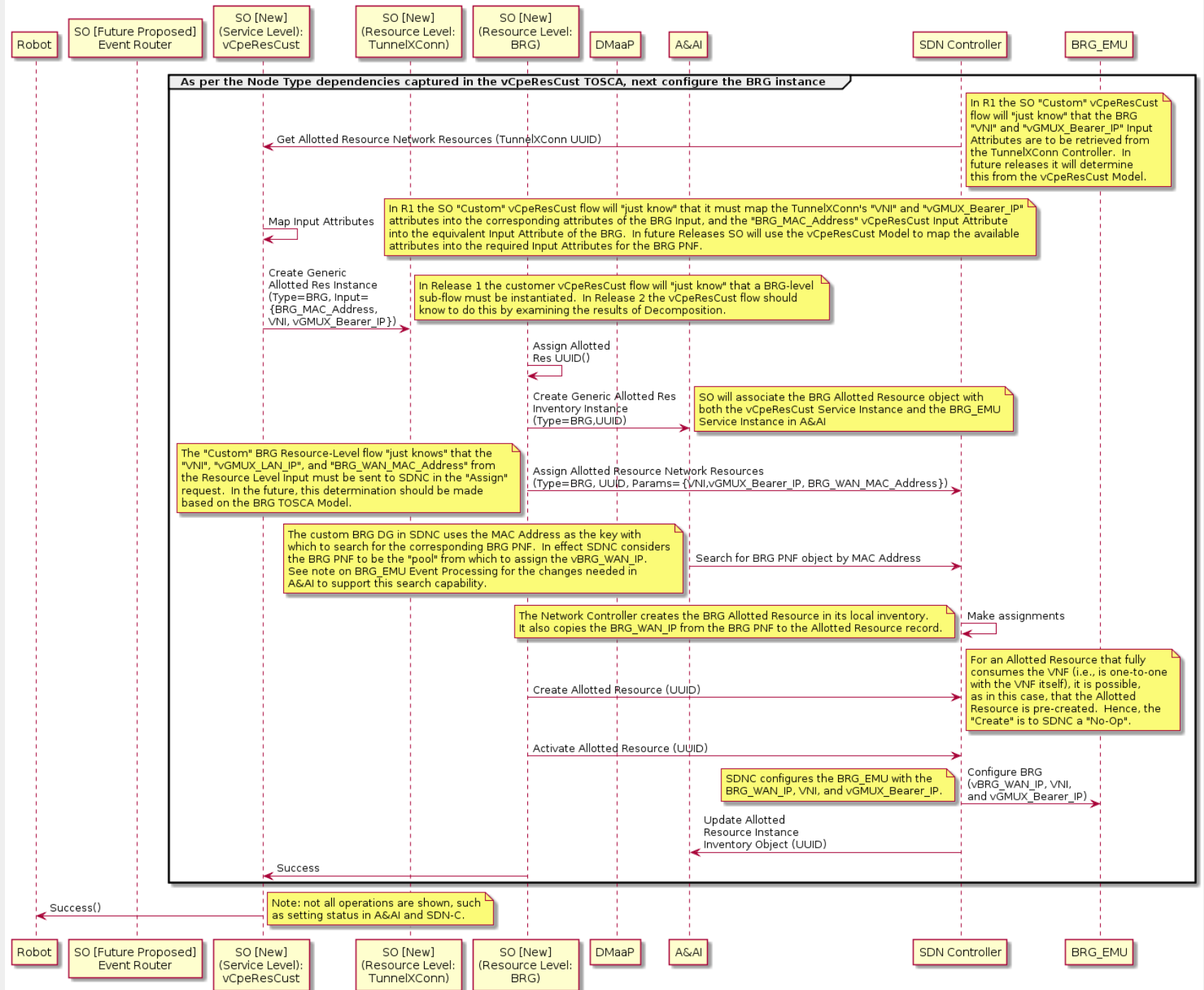

Backup Slides



Current POR

vGMUX

vCpeResCust

- Decomposition,
- Homing,
- Create Service in A&AI
- SDNC "ServiceLevel" Assign

vG – DoCreateVnfAndVfModule

TunnelXConn
(Custom)

DoCreateVfModule

BRG
(Custom)

DoCreateVnf

Generic Resource API

Generic Resource API

Generic Resource API

Generic Resource API

SDNC



Option 1 – Leverage the SO “Pause” Capability

vGMUX

vCpeResCust

Decomposition,
Homing,
SDNC “ServiceLevel” Assign

vG – DoCreateVnf

TunnelXConn
(Custom)

BRG (Custom)

vG – DoCreateVfModule

How do we get the
DoCreateVfModule to use
the Generic Resource API?

Generic Resource API

Generic Resource API

Generic Resource API

Generic Resource API

SDNC



Assign only (multi-step flag set)

Instantiate+Config only

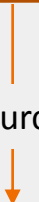

Option 2 – Assign the VNI as part of vG, and Swap Order

vGMUX

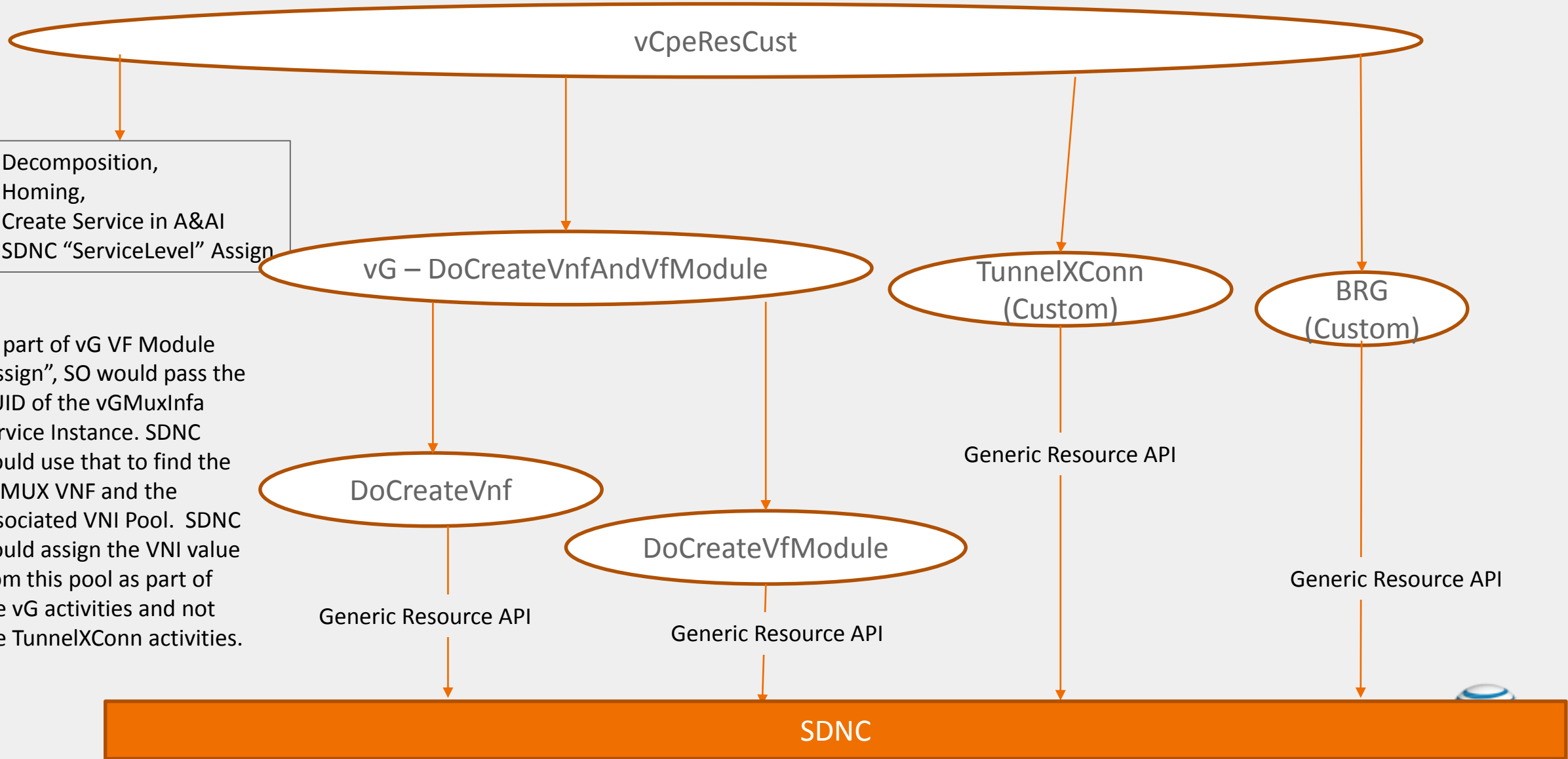

- Decomposition,
- Homing,
- Create Service in A&AI
- SDNC "ServiceLevel" Assign

As part of vG VF Module "assign", SO would pass the UUID of the vGMuxInfa Service Instance. SDNC would use that to find the vGMUX VNF and the associated VNI Pool. SDNC would assign the VNI value from this pool as part of the vG activities and not the TunnelXConn activities.

SDNC

Option 3 – Assign the vG IP address as part of the TunnelXConn

vGMUX

vCpeResCust

- Decomposition,
- Homing,
- Create Service in A&AI
- SDNC "ServiceLevel" Assign

TunnelXConn (Custom)

vG – DoCreateVnfAndVfModule

DoCreateVnf

DoCreateVfModule

BRG (Custom)

As part of the TunnelXConn assignment, SDNC will also select the IP Address of the (future) vG itself. I.e., the vG IP Address will be included in the pre-load data for the TunnelXConn, and not included in the pre-load data of the vG.

As part of the vG assignment, SDNC will look into the TunnelXConn "context" for this vCpeResCust Service Instance to determine the IP Address that was assigned for this vG.

Generic Resource API

Generic Resource API

Generic Resource API

Generic Resource API

SDNC