

# Cloud Services Architecture

**Mehmet Toy, Ph.D**

**Verizon**

**August, 2018**

# Outline

---

- **Use Cases**
- **Architecture**
- **Example: SD-WAN**
- **ETSI NFV Interfaces**
- **Mapping**
- **Enterprise vCP Service (IFA22)**

# Public cP Access via Internet

---

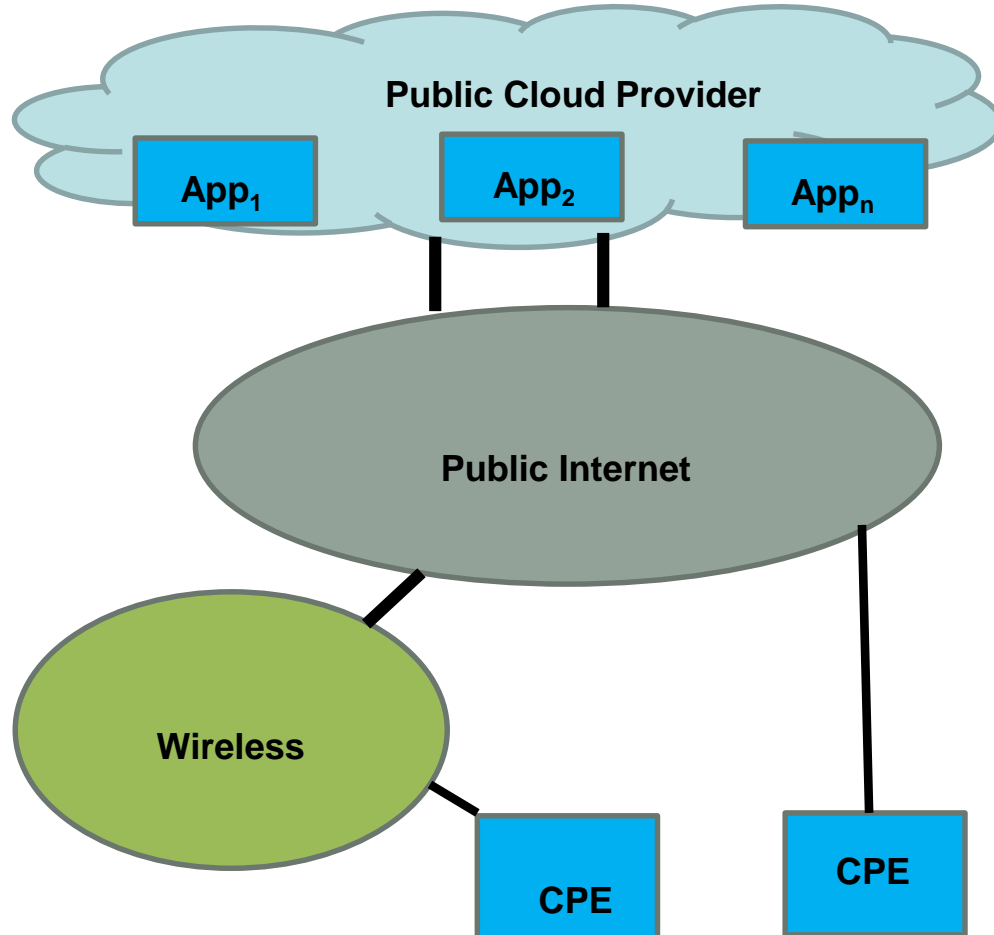

# Public cP Access via Internet and Private Network

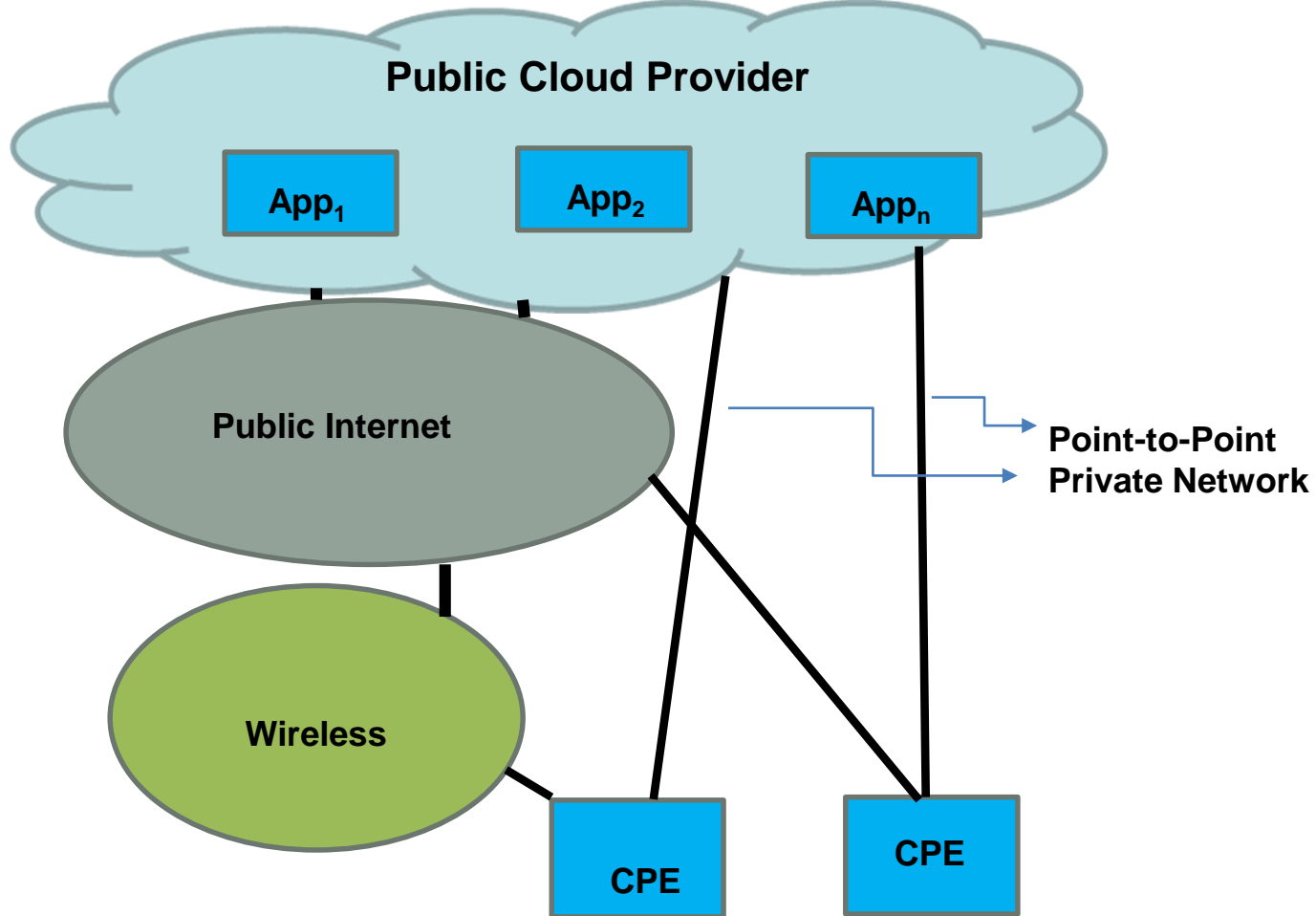

# Public cP and Private cP Access via Private Network

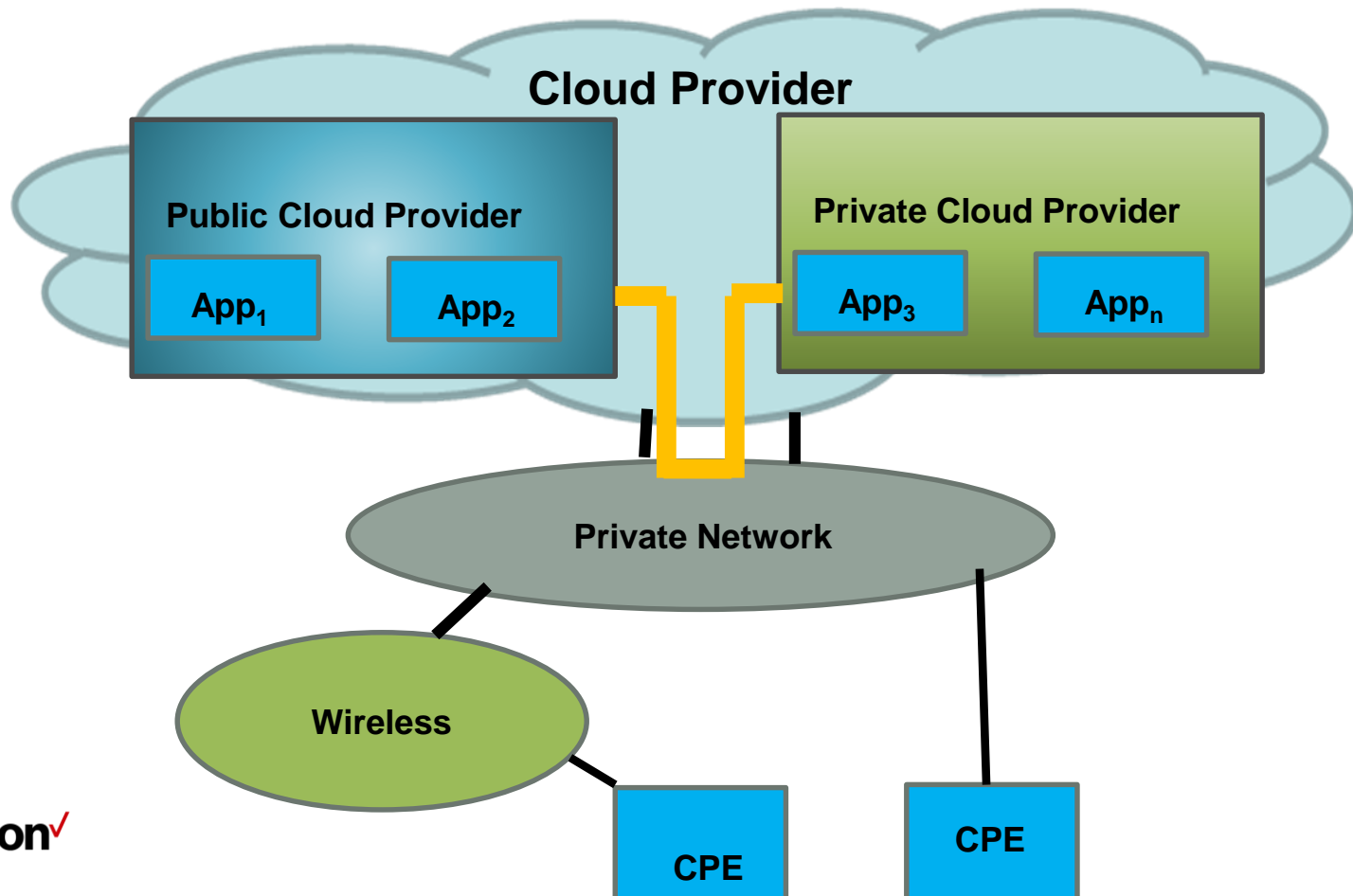

# Multiple cP Access via Internet and Private Network

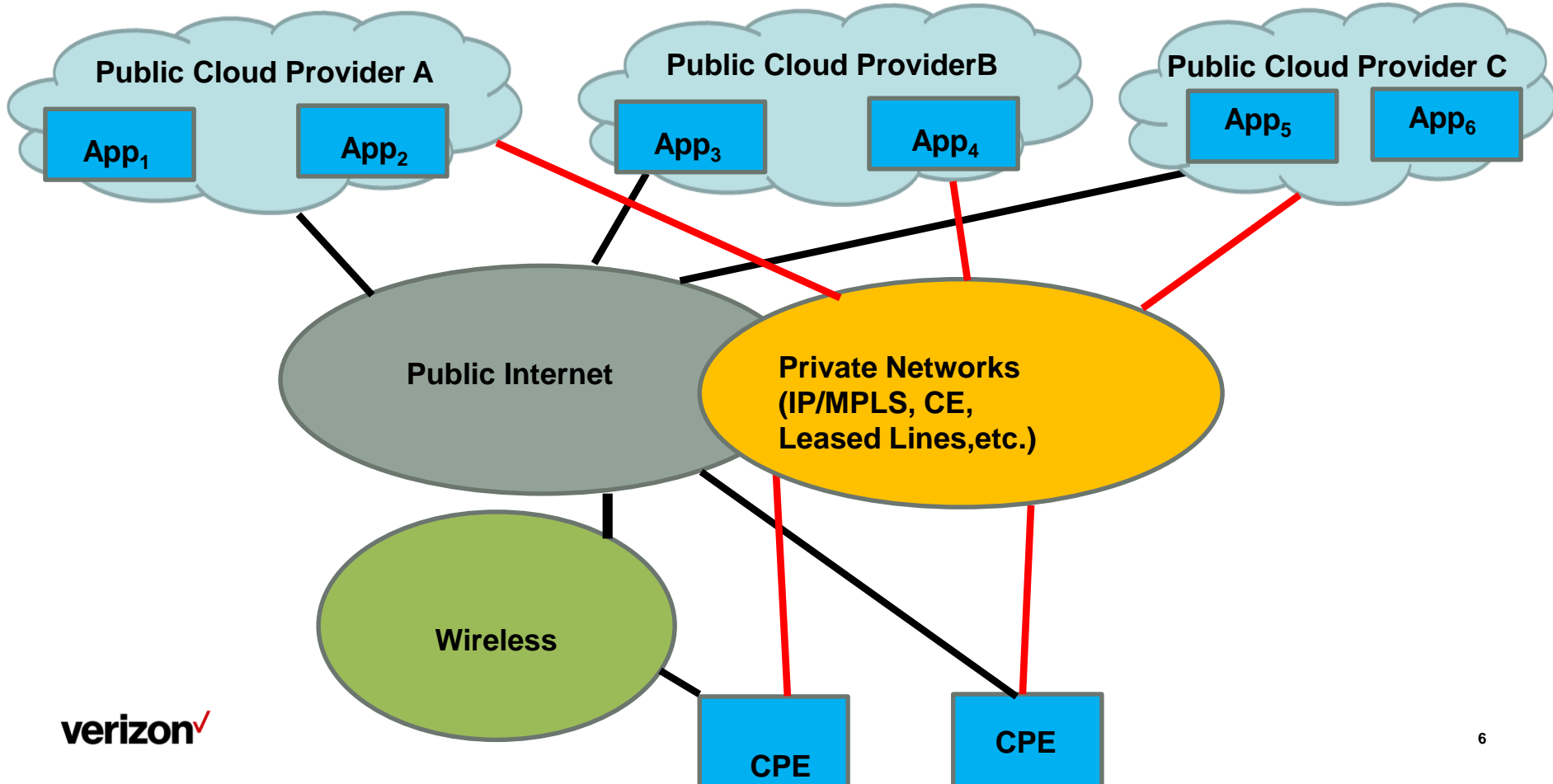

# Cloud Exchange GW

---

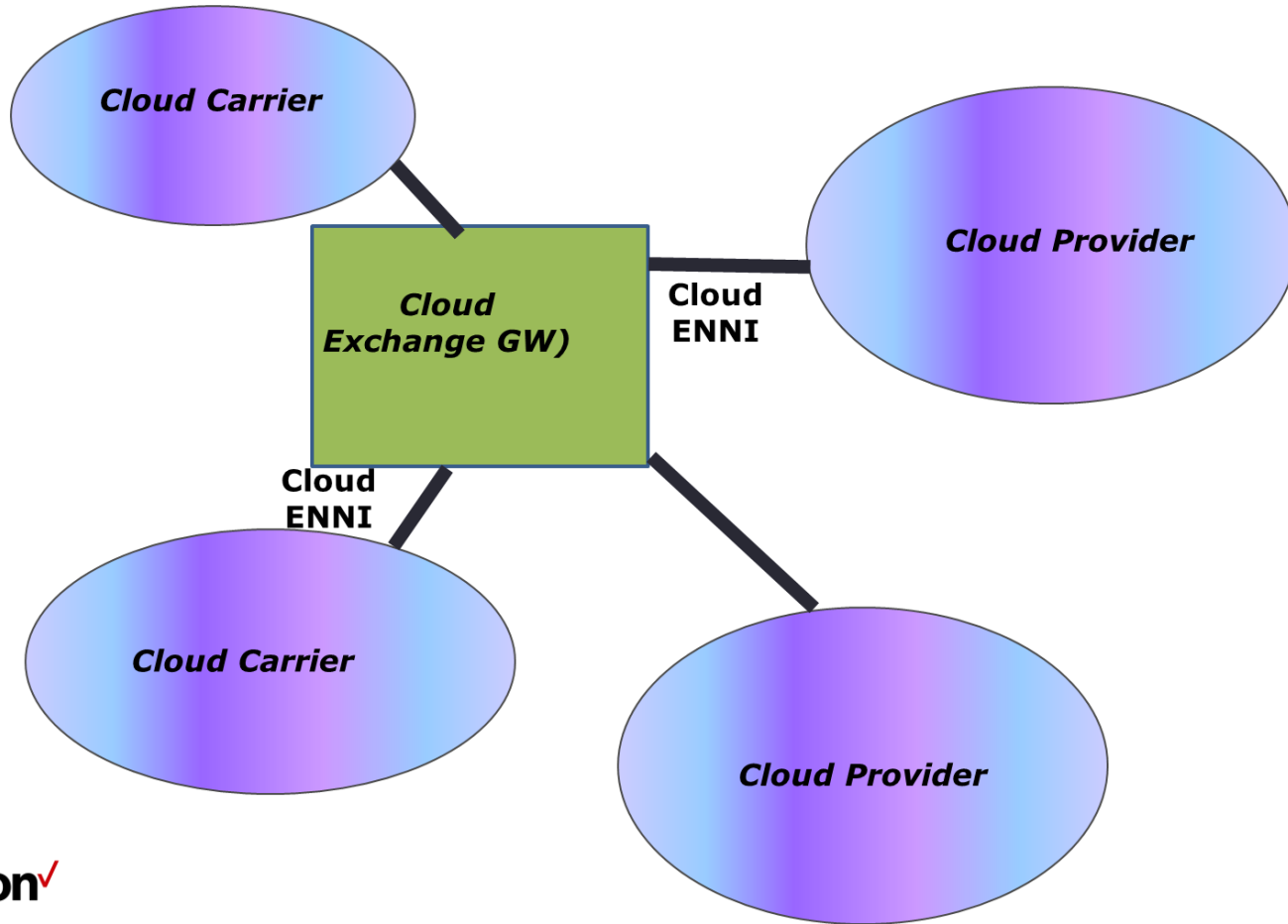

# Cloud-in-a-Box

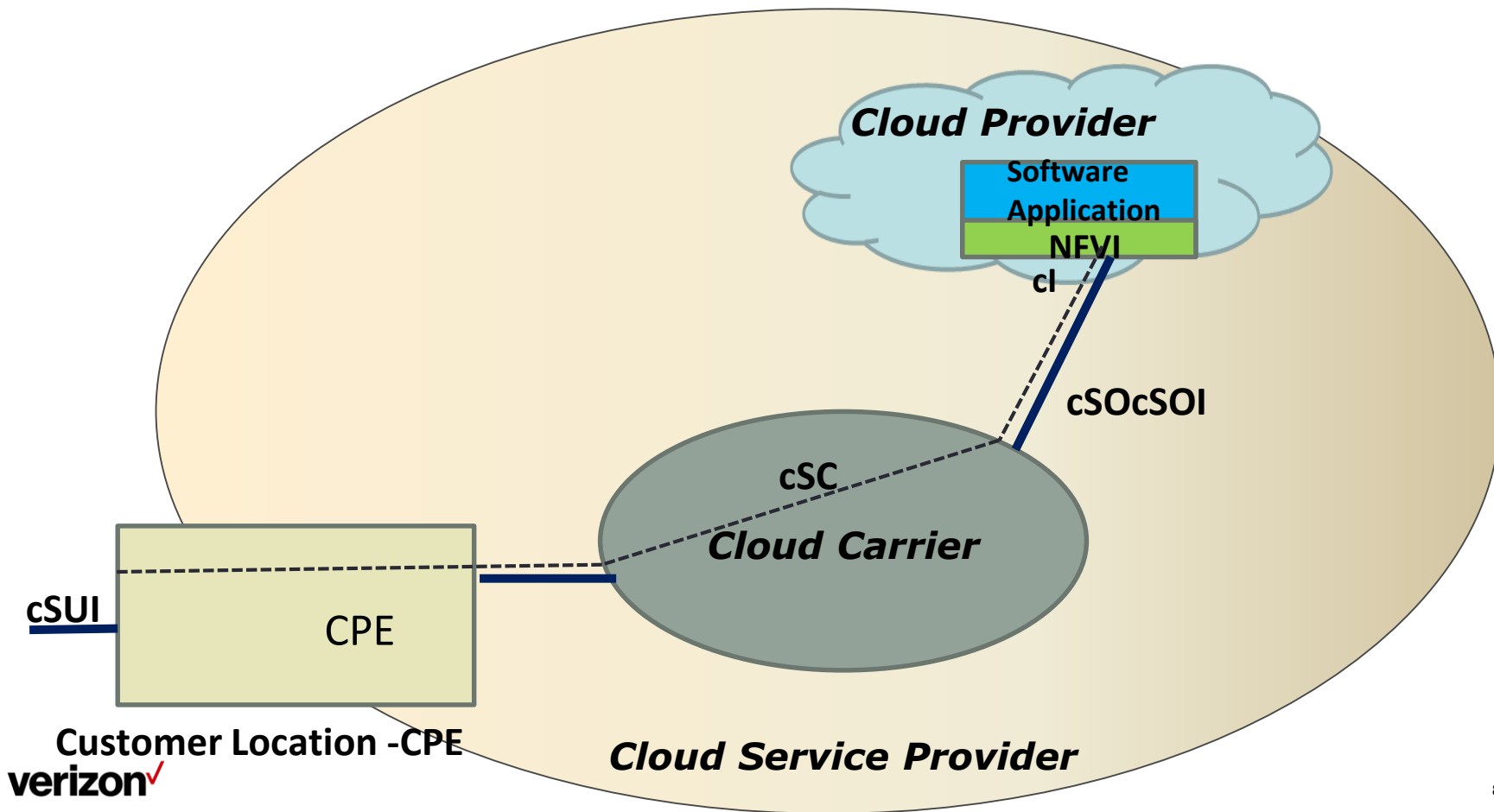



# Cloud-in-a-Box

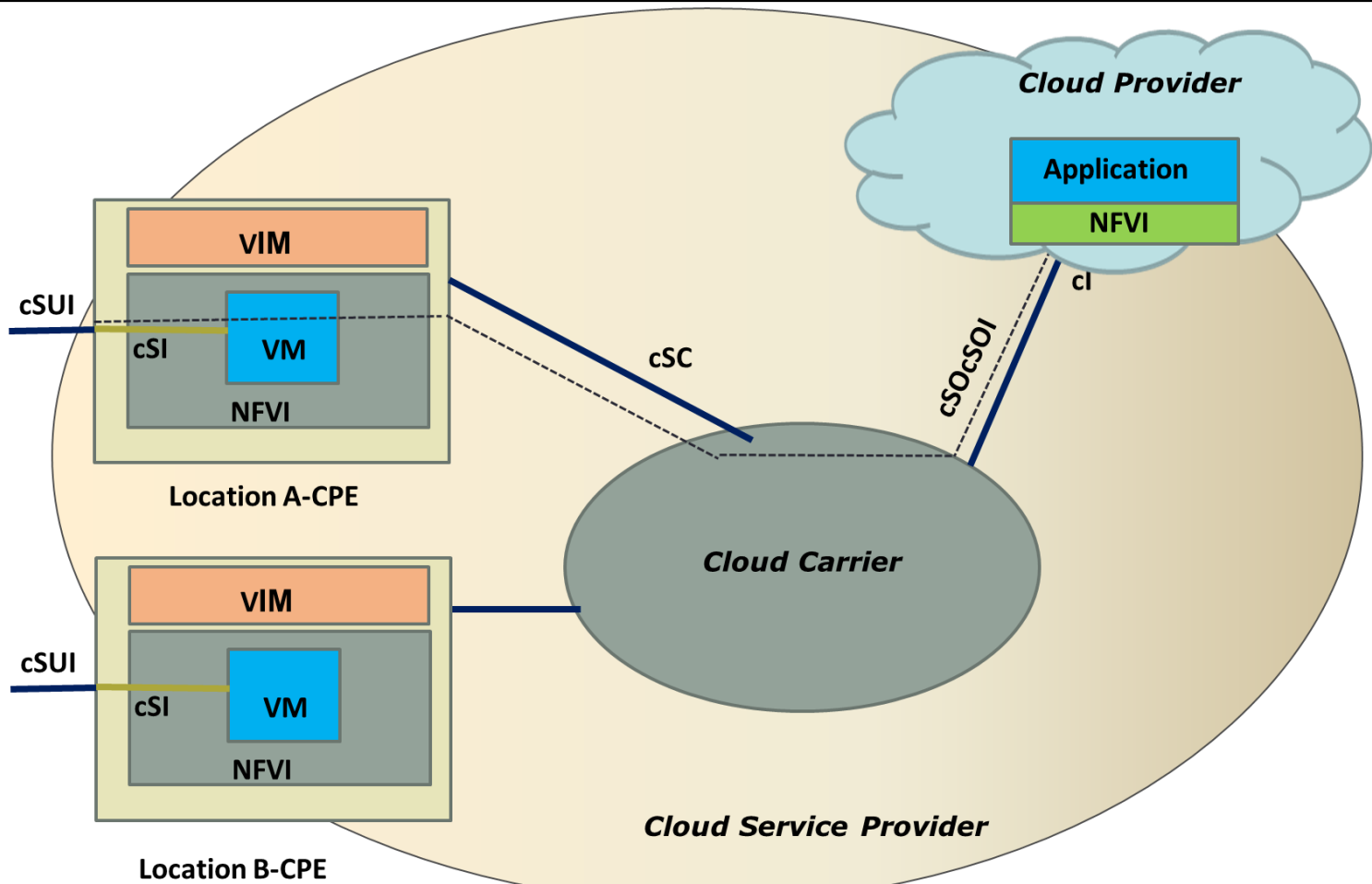

# Cloud-in-a-Box

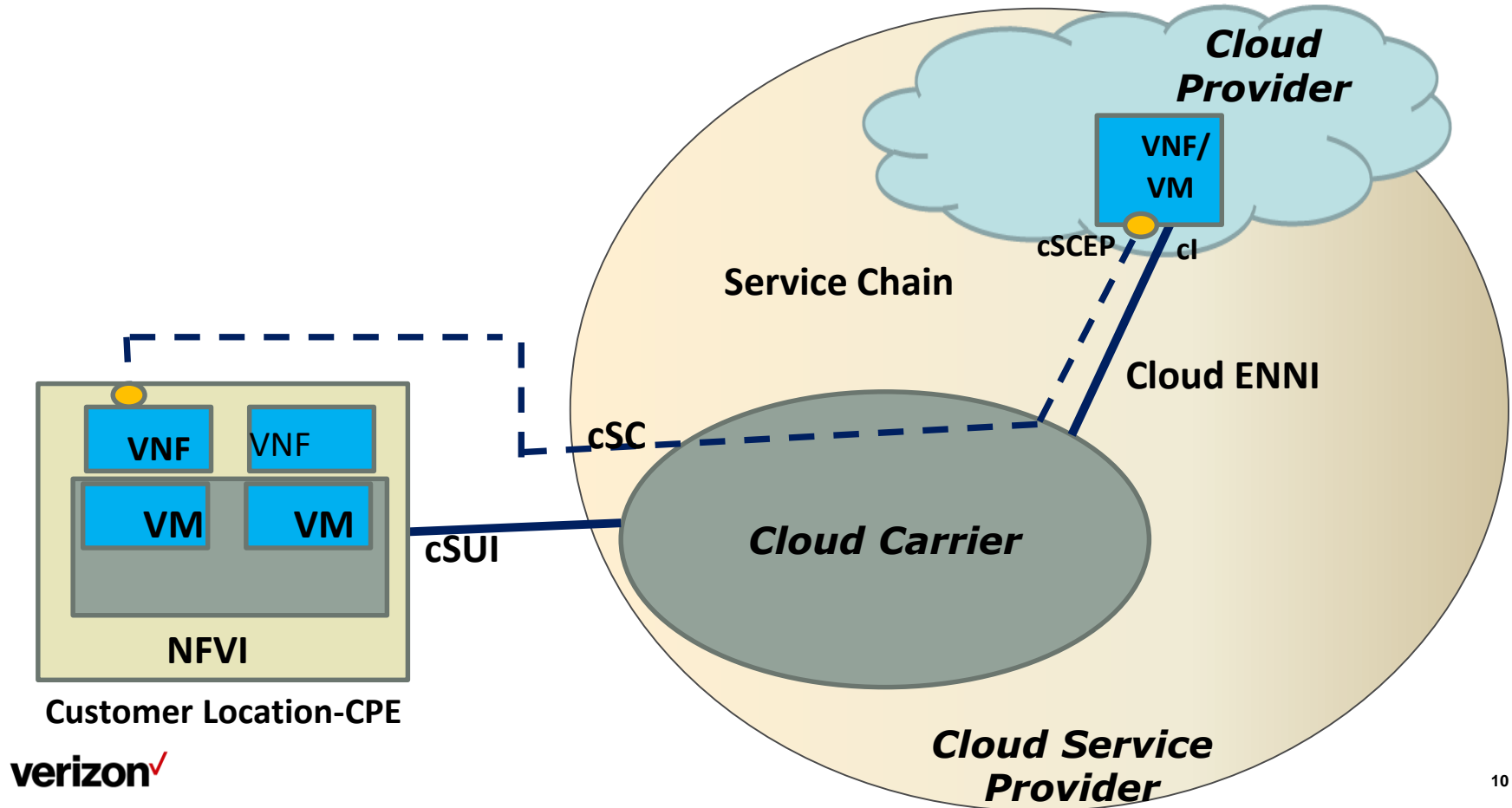

# Cloud Services

---

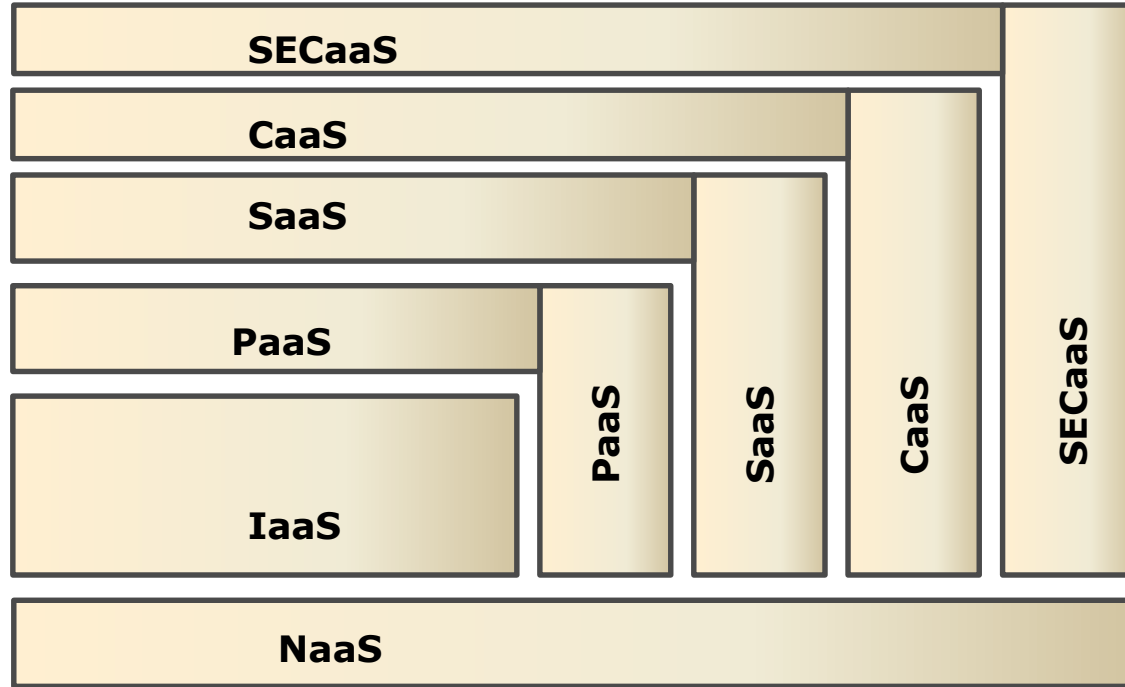

# Cloud Services Characteristics

---

- **Consists of virtualized (VNFs) and non-virtualized functionalities/components (PNFs)**
  - Network Functions (PNFs and VNFs)
  - Applications (VNFs)
  - Connections supported by PNFs and VNFs
- **VNFs and PNFs can be provided by one or more Public Cloud Provider (s), Private Cloud Providers, and Network Operators (Cloud Carriers)**

# Cloud Services Characteristics (cont.)

---

- **Elasticity: On-demand service configurations by subscribers**
- **Service monitoring and usage-tracking by subscribers**
- **Self-service and collaboration**
- **Scalability**
- **SLA (High Availability)**
- **Usage based billing**

# Actors of Cloud Services

---

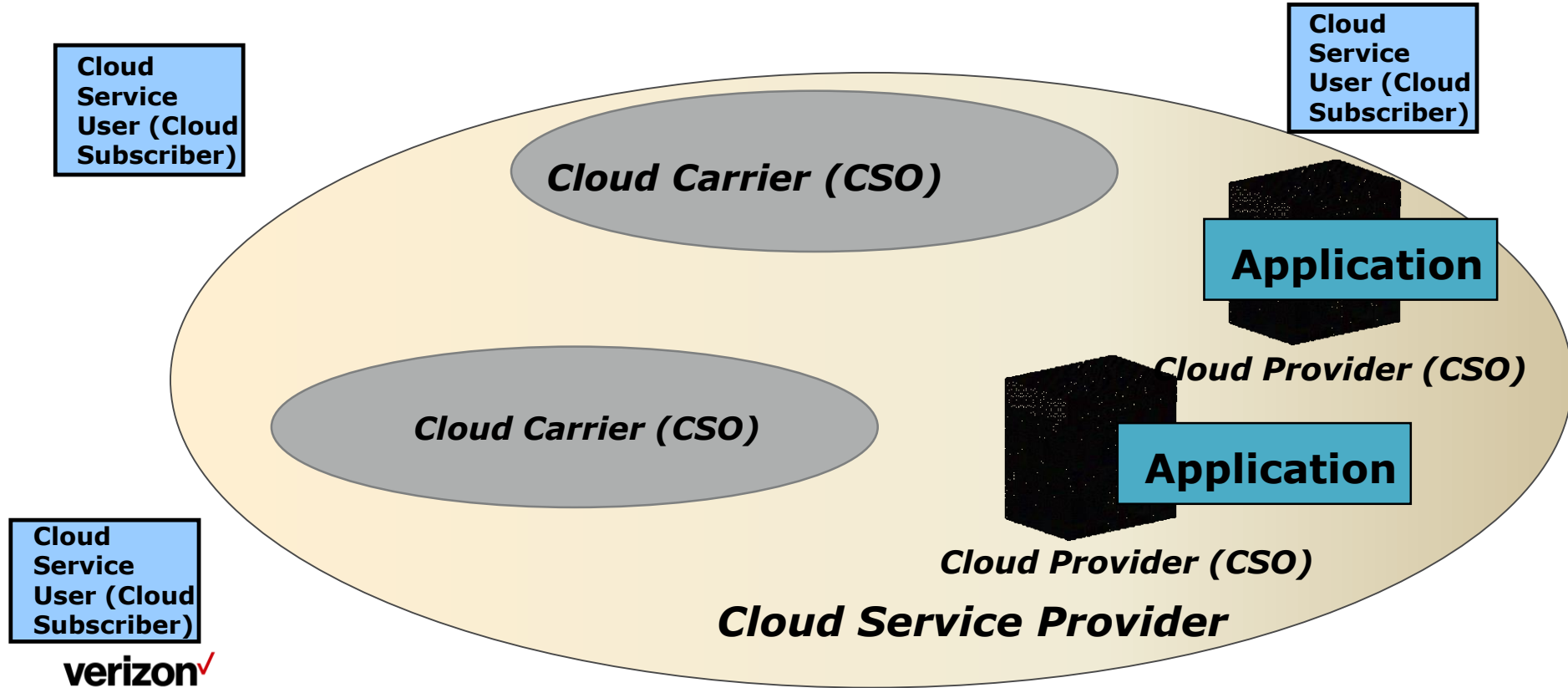

# **Purpose of Cloud Services Architecture**

---

- **Define an architecture to simplify service ordering, provisioning, maintenance and billing for Cloud Services.**
- **Define standards interfaces for communications among Cloud Users, Cloud Providers, and Cloud Carriers.**

# **Cloud Service Architectural Entities**

---

- **Cloud User (Subscriber)**
- **Cloud Service Provider**
- **Cloud Service Operator**
- **Cloud Carrier**
- **Cloud Provider**
- **Cloud Application**



# Cloud Service Architectural Entities (cont.)

- ***Cloud Service Interface*** between Cloud User and Cloud Service Provider
- ***Application Interface*** between Cloud User and Application
- ***Interface*** between Cloud Carriers
- ***Interface*** between Cloud Carrier and Cloud Provider
- ***Interface*** between Cloud Providers
- ***Connection*** between/among Cloud User(s) and Application(s)
- ***Connection*** between/among Cloud Users

# Interfaces

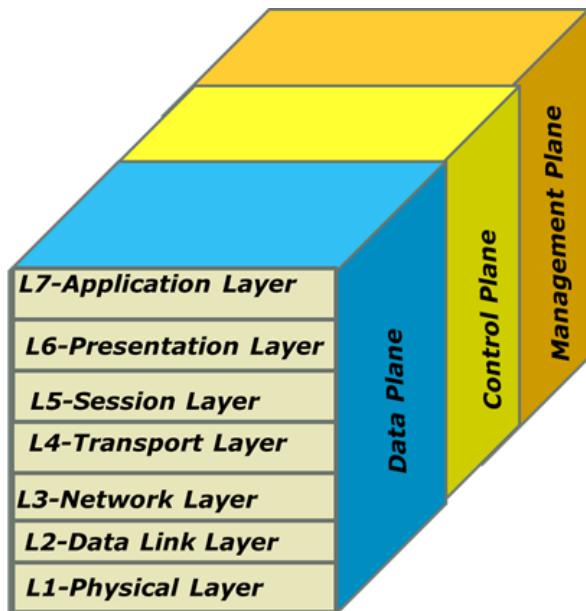

cSUI

Or  
Cloud UNI

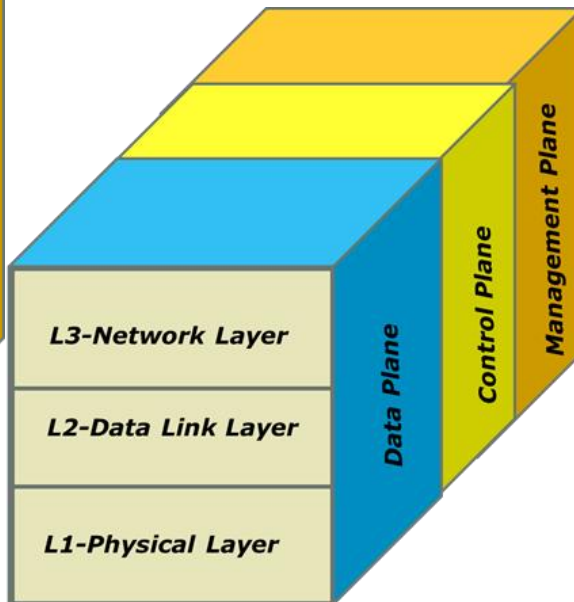

cSOcSOI

Or  
Cloud ENNI

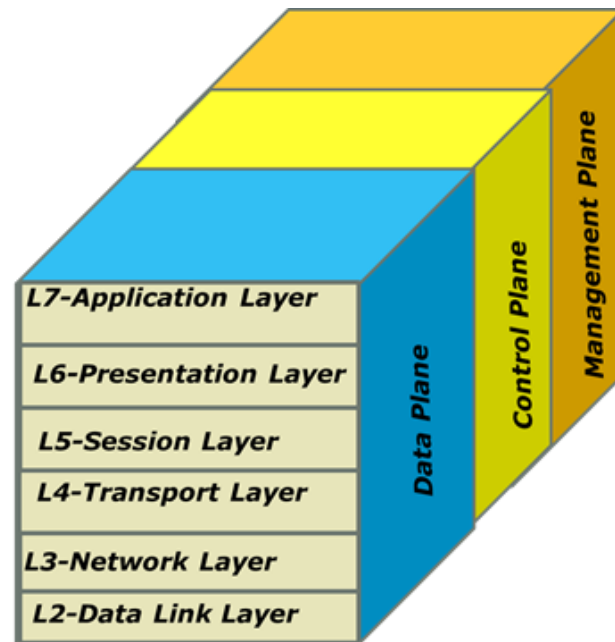

cI

# Cloud Services Architecture

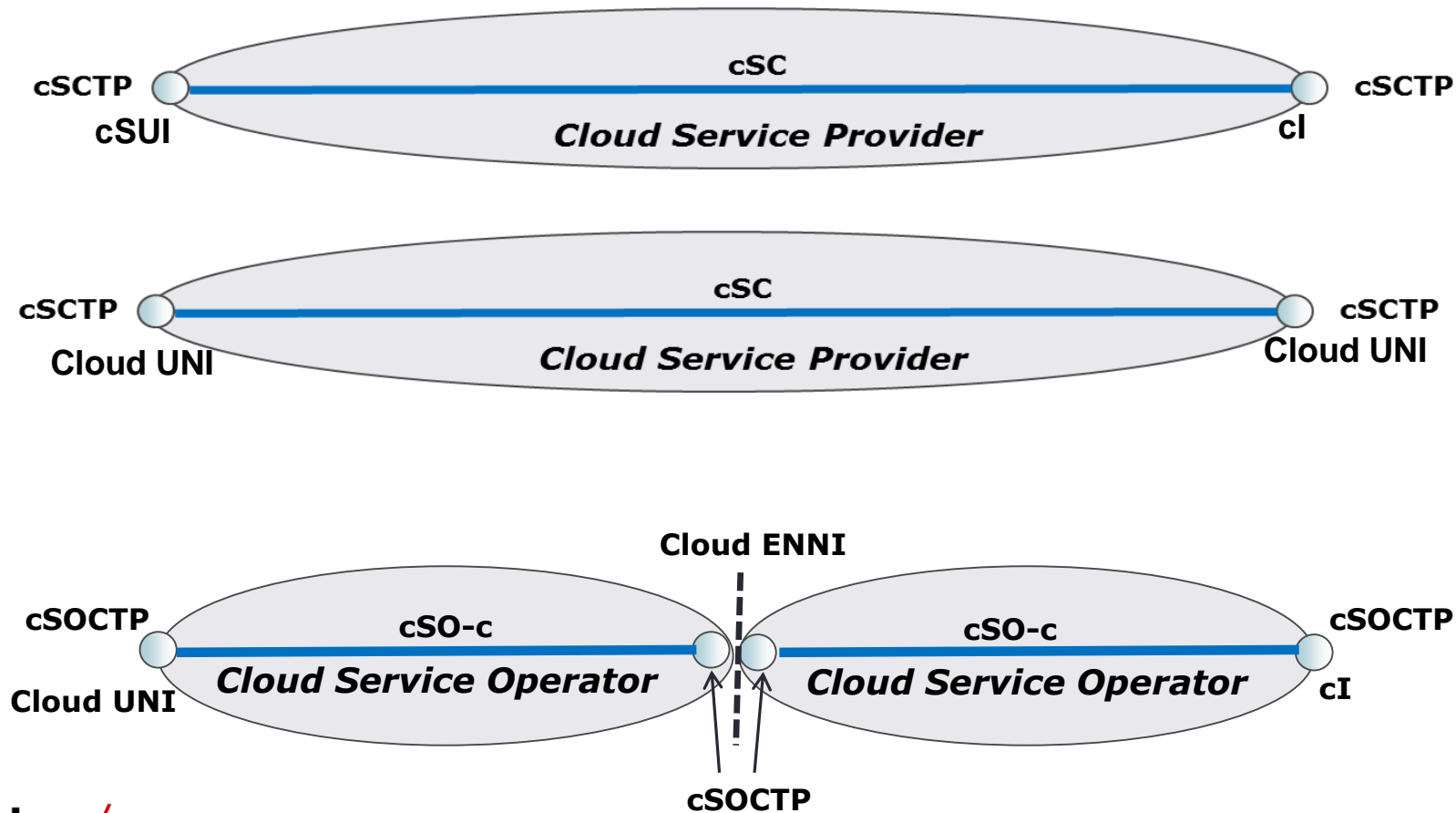

# Definitions

---

- **Cloud Service**: A service provided to a Cloud Subscriber using a shared pool of configurable resources (e.g., networks, servers, storage, applications).
- **Cloud Carrier**: An intermediary that provides connectivity and transport between Cloud Providers and Subscribers or between Cloud Providers.
- **Cloud Provider**: An entity that is responsible for making cloud applications available to Cloud Subscribers.

## **Definitions (cont.)**

---

- **Cloud Service Provider**: An entity that is responsible for the creation, delivery and billing of cloud services, and negotiates relationships among Cloud Providers, Cloud Carriers, Cloud Service Operators, and Cloud Subscribers. It is the single point of contact for the subscriber.
- **Cloud Service Operator** is an operator that provides a part of the end-to-end Cloud Service which is provided by a Cloud Service Provider.
- **Cloud Subscriber**: A person or organization that maintains a business relationship with and uses service from a Cloud Service Provider.

# Example: SD-WAN

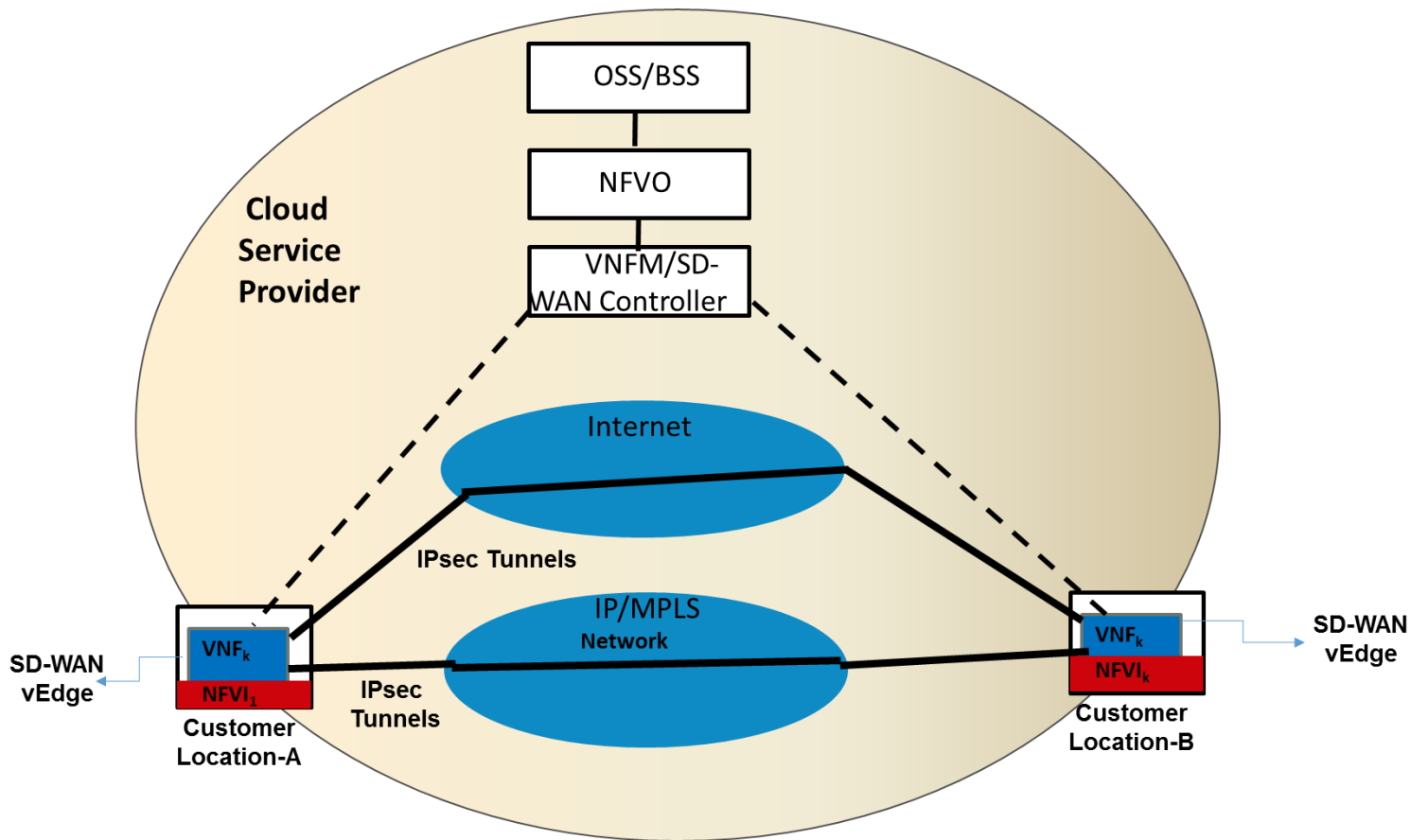

# Example: SD-WAN

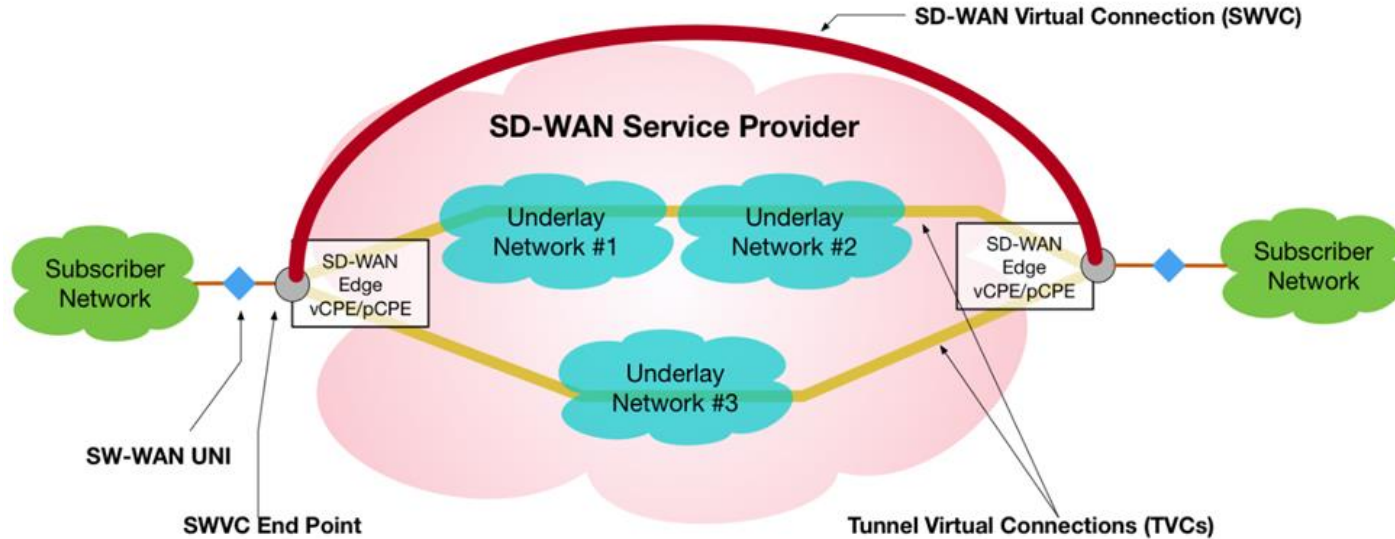

# SD-WAN UNI (cSUI)

---

Attribute Name	Summary Description	Possible Values
SD-WAN UNI ID	Identification of the SW-UNI for management purposes	Unique alphanumeric string for a given SD-WAN Service.
SD-WAN UNI List of Physical Links	<if needed> The list of physical links that compose the UNI	A list of one or more 4-tuples
SD-WAN UNI Maximum Frame Size	The maximum size of a frame that will be accepted at the UNI	An integer $\geq 1522$
SD-WAN UNI Bandwidth Profile	A characterization of the bandwidth that the Service Provider will accept at the UNI	Not specified or 6-tuple <CIR, CBS, EIR, EBS, CF, CM>.



# SD-WAN Connection (SWVC) (cSC)

Attribute Name	Summary Description	Possible Values
SWVC ID	Identification of the SWVC for management purposes	Unique alphanumeric string for a given SD-WAN Service.
SWVC Service Type	Indicates with the SWVC is provided as a NAAS service or an OIS service.	NAAS or OIS
SWVC End Point List	The SWVC End Points that are associated by the service	List of SWVC End Point Identifiers
SWVC List of Policy Identifiers	A list of policies that have been associated with the SWVC	
SWVC List of Application Identifiers	A list of applications that can have policies associated with them at an UNI.	
SWVC Encryption	Indicates whether the SWVC is encrypted. If encrypted, specifies the type of encryption used for the SWVC.	Encryption Type

# **SD-WAN Connection End Point (SWVC EP) (cSCTP)**

---

<b>Attribute Name</b>	<b>Summary Description</b>	<b>Possible Values</b>
<b>SWVC End Point ID</b>	<b>Identification of the SW-UNI for management purposes</b>	<b>Unique alphanumeric string for a given SD-WAN Service.</b>
<b>SWVC End Point UNI</b>	<b>Identifies the UNI that the End Point is associated with</b>	<b>An SD-WAN UNI ID</b>
<b>&lt;others&gt;</b>		

# cSUI

---

- Attributes
- Dynamic Attributes
- Traffic Management
- Fault Management
- Performance Management
- Security
- Billing

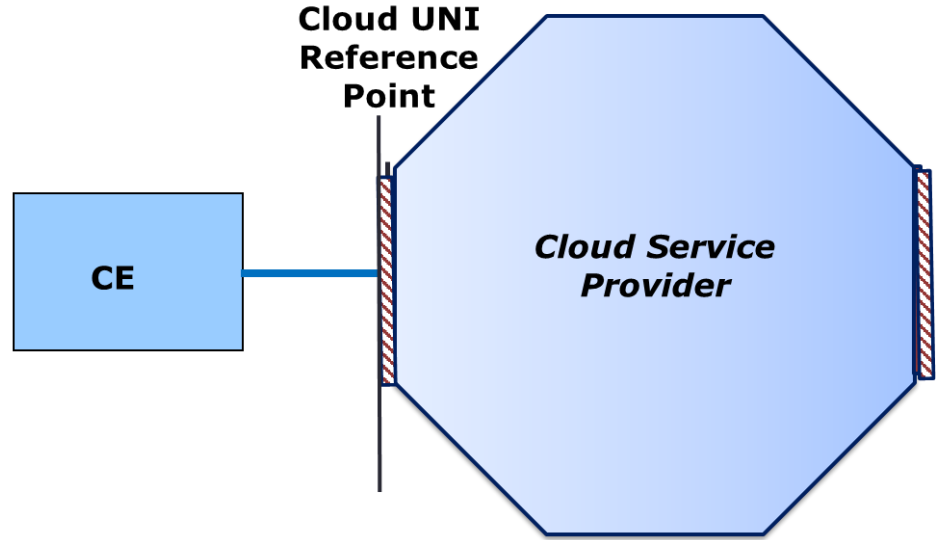

# cSUI Attributes (cont.)

---

- *cSUI Id, Tenant ID*
- *NaaS Id*
- *Physical Interface: Ethernet, DOCSIS, EPON, GPON, WDM, SONET/SDH, OTN*
- *MTU*
- *Connection Multiplexing*
- *Maximum Number of Connection Termination Points*
- *L2 Configuration Attributes [MEF10.3-MEF UNI], PPP, PPTP, ....*
- *L2 SOAM Attributes [MEF30.1 and 30.2]*
- *MPLS UNI Attributes [MPLS PVC User-to-Network Interface]*
- *IPv4 address, IPv6 address*
- *IP VPN*
- *L4 attributes*
- *L5 attributes*
- *L6 attributes*
- *L7 attributes*
- *Interface Level Security*
- *Service Level Security*
- *Operational State*
- *Administrative State*

# cl

---

- Attributes
- Dynamic Attributes
- Traffic Management
- Fault Management
- Performance Management
- Security
- Billing

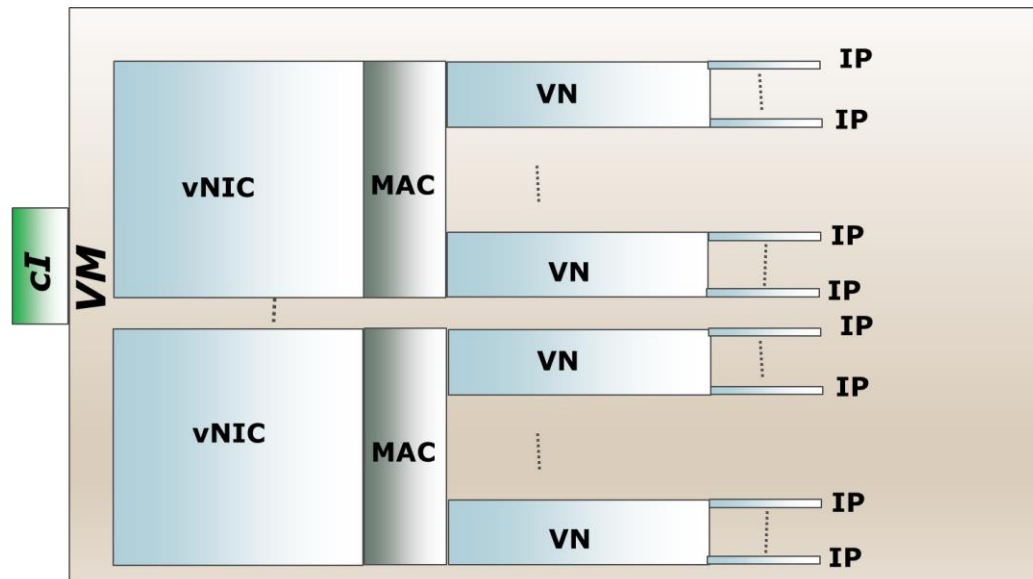

# Cloud Interface

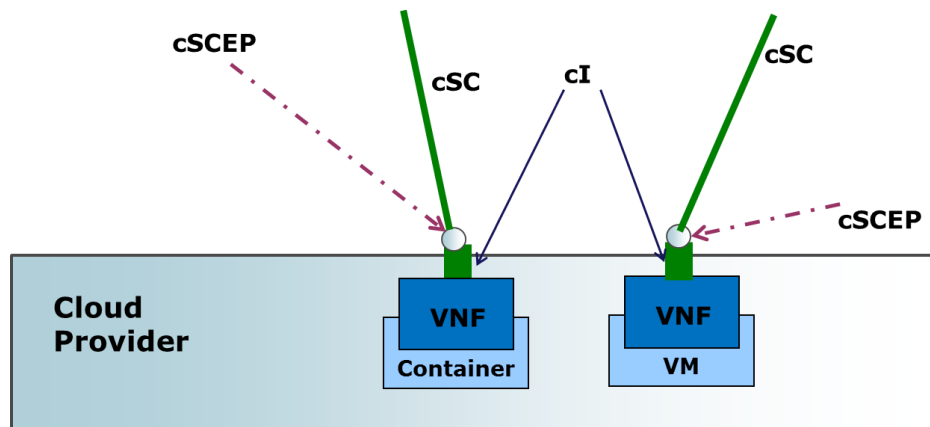
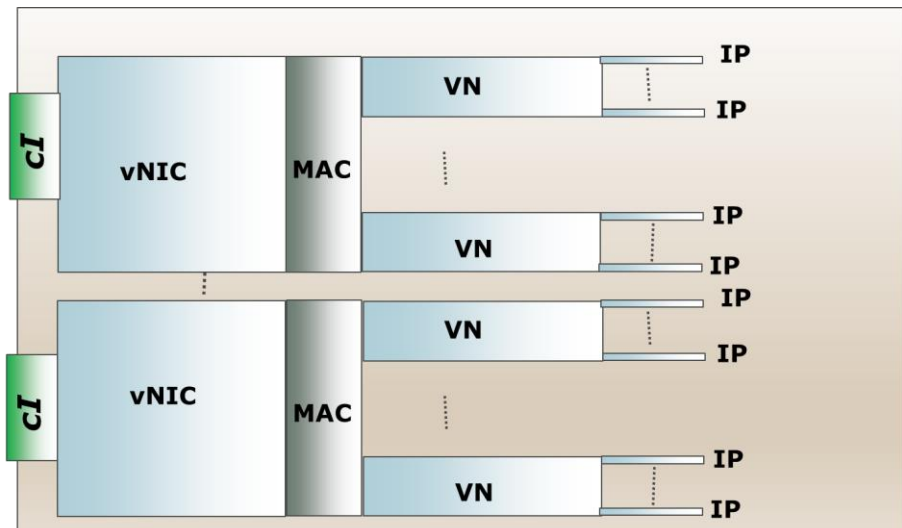

# Cloud Interface

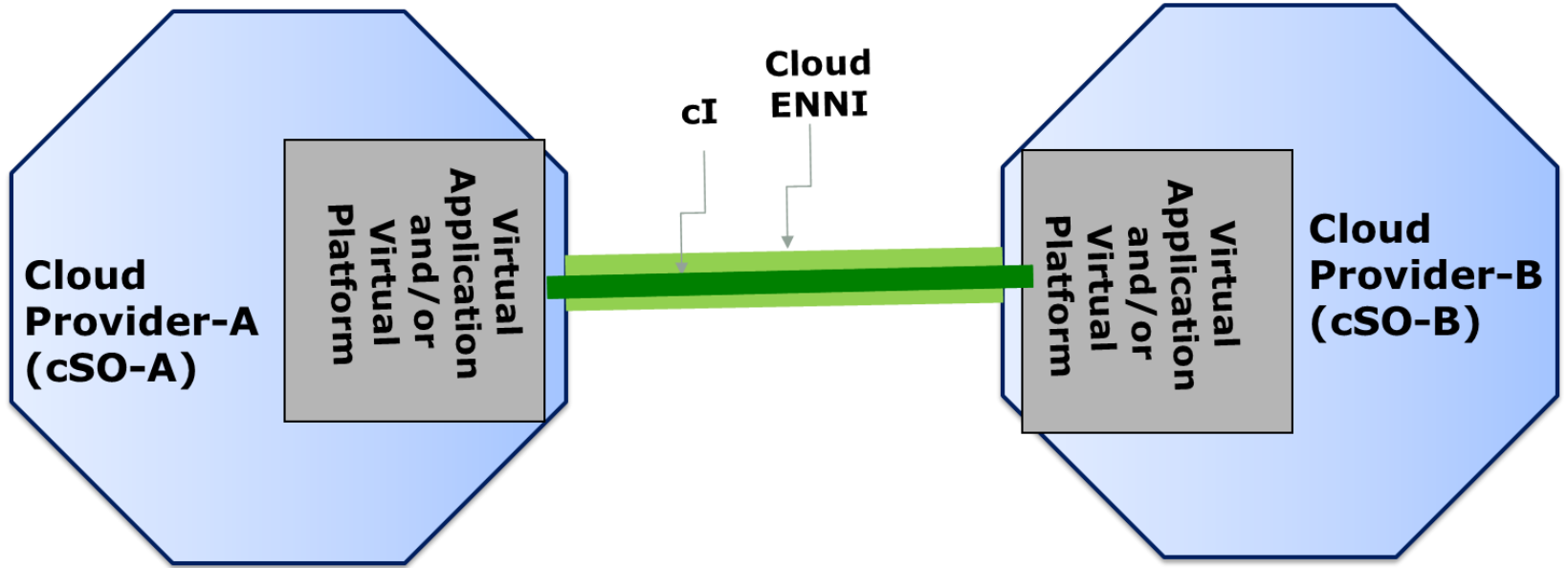

# cl Attributes

---

- *cSI Id, VM ID*
- *List of NaaS Ids*
- *Interface Protection*
- *VM/VNF Protection*
- *MTU*
- *Connection Multiplexing*
- *Maximum Number of Connection Termination Points*
- *VM Portability*
- *L2 Configuration Attributes [MEF10.3-MEF UNI], PPP, PPTP, ....*
- *L2 SOAM Attributes [MEF30.1 and 30.2]*
- *MPLS UNI Attributes [MPLS PVC User-to-Network Interface]*
- *IPv4 address, IPv6 address*
- *IP VPN*
- *L4 attributes*
- *L5 attributes*
- *L6 attributes*
- *L7 attributes*
- *Interface Level Security*
- *Service Level Security*
- *Operational State*
- *Administrative State*



# Virtual Firewall

---

- **License**
- **VM Flavor: vCPU, Memory, Disk, Ephemeral Disk for temporary storage**
- **Bandwidth, auto, full-duplex, MTU**
- **Addressing mode (manual, DHCP), VLAN ID**
- **DNS, NTP**
- **vNIC Name, vNIC Port Number**
- **Affinity-VM or Anti-Affinity-VM**
- **Type of Operation: Transparent, NAT/Route**
- **Intrusion detection, virus detection, web access blocking, anti-spam, botnets, ...**

# Some of vR Attributes

---

- **Single tenant, multiple tenants, router IDs**
- **Routing tables and Interfaces that belong to these routing tables**
- **Static Routing**
- **Loopback Address**
- **NTS Server IP**
- **Routing table groups**
- **Multicast scoping**
- **Routing protocol and option configurations**
- **Per-packet load balancing (equal cost multipath routing)**
- **Autonomous system numbers**
- **Autonomous system confederation members**

## **Some of vR Attributes (Cont.)**

---

- **ICMP, BFD, BFD Authentication**
- **Dynamic Routing: RIP (export filters), OSPF (ospf area, vlinks, import filters, authentication type)**
- **DHCP Relay**
- **MAC addresses, IP addresses, IPv6**
- **Layer 3 host entries**
- **Longest prefix match (LPM) table entries**
- **Redundancy Protocol**

# vSBC

---

- **HA Pair**
- **MTU**
- **Link Redundancy**
- **ACL**
- **Idle timer for TCP connections**
- **SCTP-based SIP Port**
  - **Stream Control Transmission Protocol (SCTP) as a Transport for the Session Initiation Protocol (SIP)**
- **Support of H.323 signaling**
- **Support of G.721 ITU-T standard codec that uses Adaptive Differential Pulse Code Modulation (ADPCM)**

# SBC Protocol Stack

---

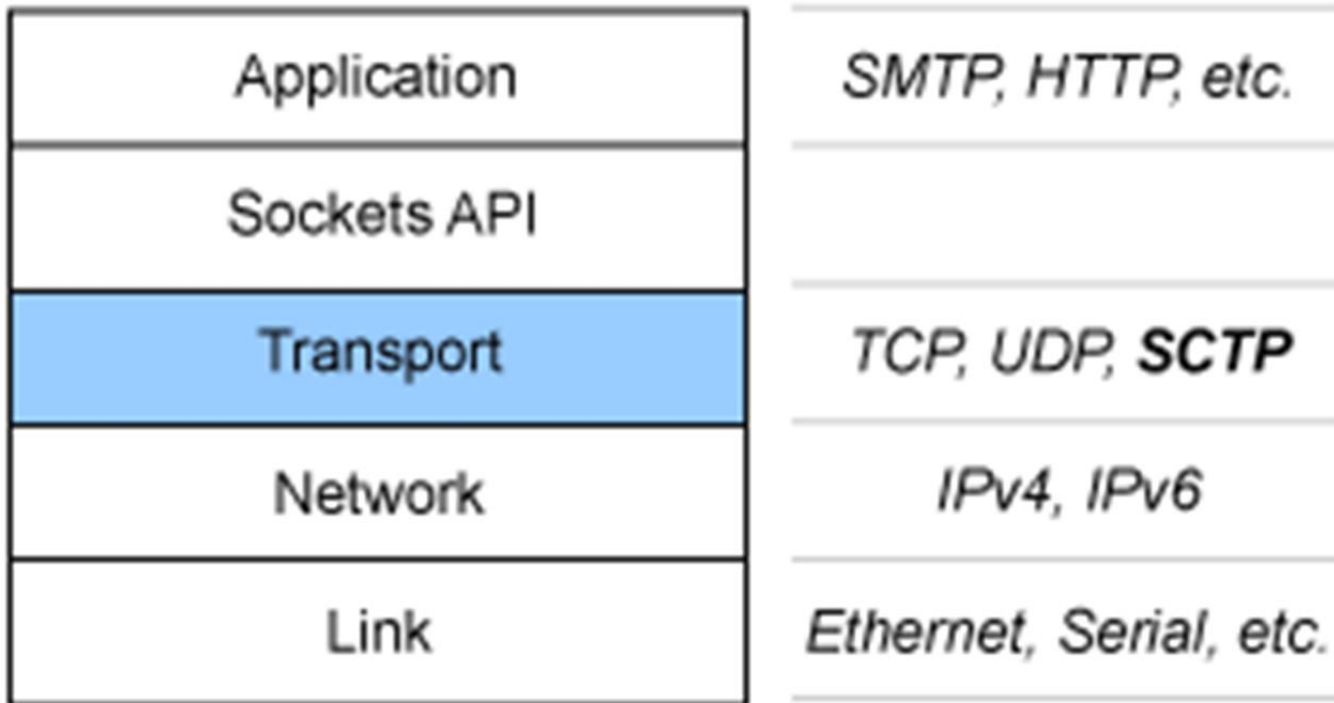

# cSC Attributes

---

- ***Attributes***
- ***Dynamic Attributes***
- ***SLOs***
- ***Fault Management***
- ***Performance Management***
- ***Protection***
- ***Billing***

# cSC Attributes

cSC attributes	
cSC Id	
List of associated cSCTP Ids	
Overlay Network Attributes	VNI ID
Type	Point-to-Point
	Point-to-Multipoint
	Multipoint-to-Multipoint
Protection	1:1 or 1+1
L2 Ethernet connection attributes [71,47]	
MEF EVC Service attributes in Table 6 of MEF 6.2 [70]	
MEF EVC Service attributes of EPL in Table 9 of MEF 6.2 [70]	
MEF EVC Service attributes of EVPL in Table 12 of MEF 6.2 [70]	
MEF EVC Service attributes of EP-LAN in Table 15 of MEF 6.2 [70]	
MEF EVC Service attributes of EVP-LAN in Table 18 of MEF 6.2 [70]	
MEF EVC Service attributes of EP-Tree in Table 21 of MEF 6.2 [70]	
MEF EVC Service attributes of EVP-Tree in Table 24 of MEF 6.2 [70]	
MEF EVC Performance attributes and Parameters per CoS in Table 25 of MEF	

# cSC Attributes (Cont.)

cSC attributes	
L3 connection attributes (if supported)	Service Level Objectives (SLOs)
	MTU
	Type
Connection Start Time	
Connection Start Interval (Start Interval parameter to indicate the acceptable interval after the Start Time during which the service attribute modifications can be made.) [80]	
Connection Duration	
Connection Period	
Operational State	
Administrative State	
Billing Options	Monthly, Hourly



# Cloud Services by Two Operators

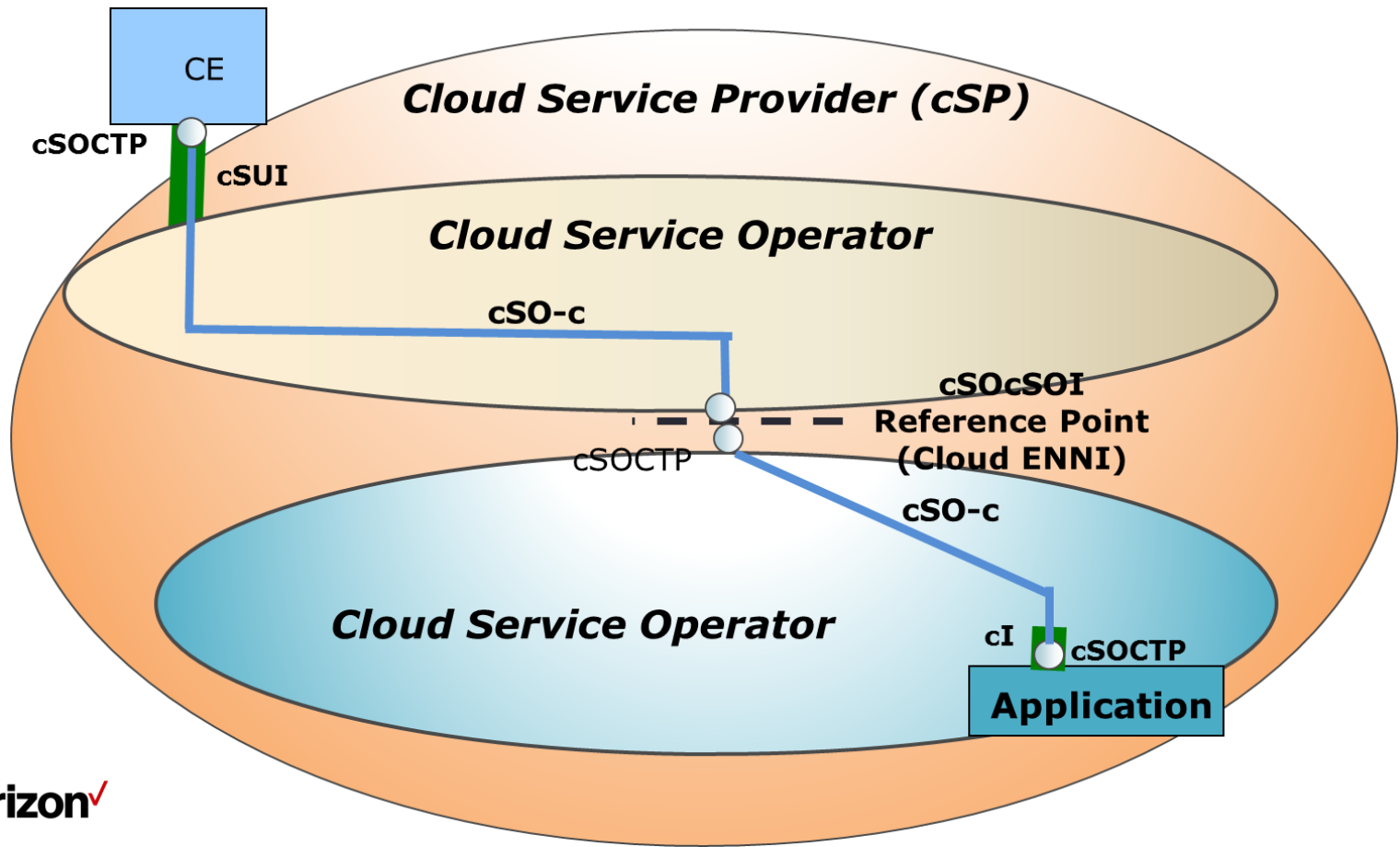

# Cloud Services by Two Operators (cont.)

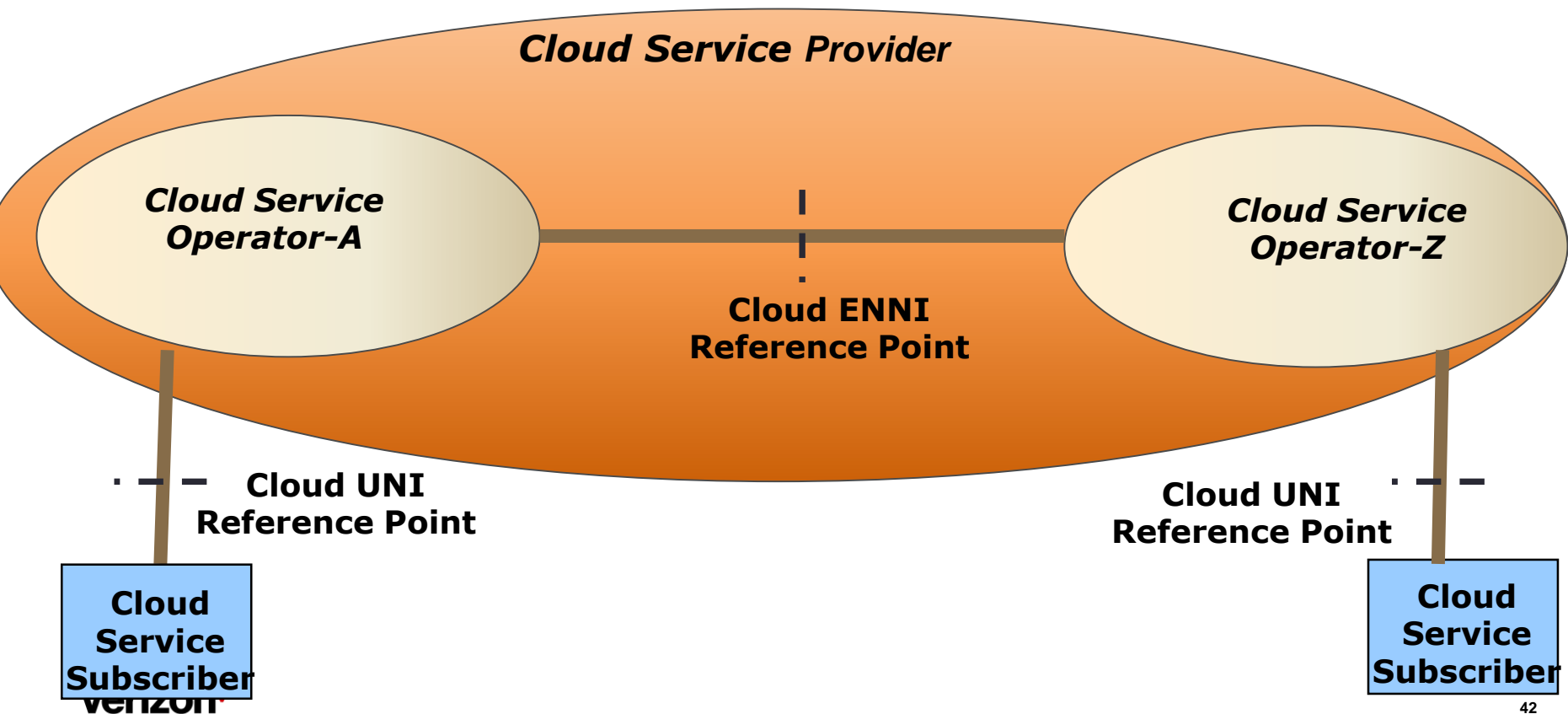

# Cloud Services by Two Operators (cont.)

---

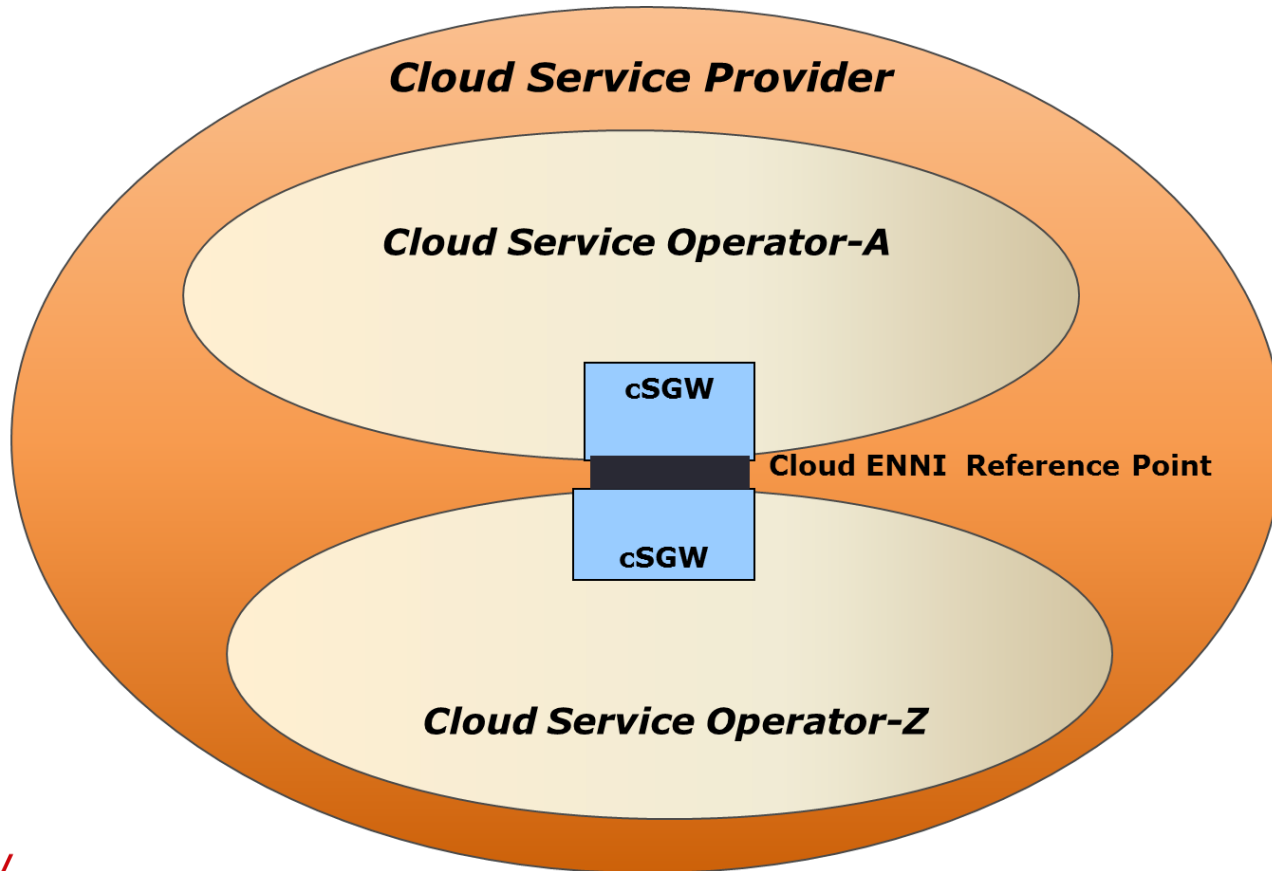

# Cloud ENNI Attributes

---

- ***Attributes***
- ***Dynamic Attributes***
- ***Traffic Management***
- ***Fault Management***
- ***Performance Management***
- ***Link Protection***
- ***Security***
- ***Billing***

# Cloud ENNI Attributes

## Cloud ENNI attributes

Cloud ENNI Id

Names of cSOs interfacing each other

Physical Interface

L2 Ethernet[4 ]

DOCSIS if supported [5,6 ]

EPON if supported[7,8 ]

GPON if supported[ 9]

WDM if supported[10,11 ]

SONET/SDH if supported [12,13]

Optical Transport Network (OTN) [78]

MTU

Connection Multiplexing

Maximum number of Connection Termination Points (or End Points)

L2 Ethernet configuration attributes[20,22]

MEF ENNI Service attributes in Table 2 of MEF 26.1 [22]

MEF ENNI L2CP Service Attributes for Access EPL in Table 17 of MEF 45 [69]

MEF ENNI L2CP Service Attributes for UTA in Table 20 of MEF 45 [69]

MEF ENNI L2CP Service Attributes for vNID Case A in Table 25 of MEF 45 [69]

MEF ENNI L2CP Service Attributes for vNID Case B in Table 28 of MEF 45 [69]

# Cloud ENNI Attributes

<b>Cloud ENNI attributes</b>
<b>L2 Ethernet SOAM attributes [25]</b>
<b>Maintenance Entity Group (MEG) Id</b>
<b>Maintenance End Point (MEP) Id</b>
<b>MEP Level</b>
<b>Maintenance Intermediate Point (MIP) Id</b>
<b>LAG MEG</b>
<b>LAG Link MEG</b>
<b>Operator MEG</b>
<b>Other L2 Protocols such as Point-to-Point Protocol (PPP) and Point-to-Point Tunneling Protocol (PPTP) if supported</b>
<b>L3 attributes if L3 protocol such as IP and MPLS are supported</b>
<b>MPLS UNI attributes [49] if MPLS is supported</b>
<b>Fast Reroute [71,62]</b>
<b>NAT</b>
<b>IPv4 Subnet Address</b>
<b>IPv6 Subnet Address</b>
<b>DSCP Marking</b>
<b>IPv4 VPN [31]</b>
<b>IPv6 VPN [32]</b>

# Cloud ENNI Attributes

---

<b>cSPcSPI attributes</b>
<b>Security between cSPs (if supported)</b>
<b>ACL</b>
<b>Packet encryption</b>
<b>Connection Authentication</b>
<b>Service Level Security</b>
<b>Billing</b>

# cSCTP Attributes

---

- *Attributes*
- *Dynamic Attributes*
- *Traffic Management*
- *Fault Management*
- *Performance Management*
- *Protection*
- *Security*



# cSCTP

## cSCTP attributes

cSCTP Id

cSUI Ids and cSI Ids

cSC Id

Overlay Network Attributes

## L2 Ethernet attributes

MEF EVC per UNI Service attributes in Table 5 of MEF 6.2 [70]

MEF EVC per UNI Service attributes for EPL Service in Table 8 of MEF 6.2 [70]

MEF EVC per UNI Service attributes for EVPL Service in Table 11 of MEF 6.2 [70]

MEF EVC per UNI Service attributes for EP-LAN Service in Table 14 of MEF 6.2 [70]

MEF EVC per UNI Service attributes for EVP-LAN Service in Table 18 of MEF 6.2 [70]

MEF EVC per UNI Service attributes for EP-Tree Service in Table 20 of MEF 6.2 [70]

MEF EVC per UNI Service attributes for EVP-Tree Service in Table 23 of MEF 6.2 [70]

MEF EPL Option 2 L2CP Processing Requirements in Table 8 of MEF 45 [69]

MEF EPL Option 2 L2CP Processing Recommendations in Table 9 of MEF 45[69]

Protection (via redundant cSCTP on a different physical port of the same CE or different CE at cSUI, and on a different VM at cSI)

## L2 Ethernet SOAM attributes

Maintenance Entity Group (MEG) Id

 Maintenance End Point (MEP) Id

MEP Level

# cSCTP Attributes

---

<b>cSCTP attributes</b>
<b>L3 attributes if interface is L3</b>
<b>IPv4 Subnet Address</b>
<b>IPv6 Subnet Address</b>
<b>DSCP Mapping</b>
<b>Bandwidth Profile</b>
<b>Protection (via redundant cSCTP on a different port of the same CE or different CE providing the cSUI, and on a different VM of the application entity providing cSI)</b>
<b>LSP Label</b>
<b>EXP Mapping</b>
<b>Operational State</b>
<b>Administrative State</b>
<b>cSCTP Level Security</b>
<b>Packet encryption</b>
<b>Connection Authentication</b>
<b>Data confidentiality/privacy</b>
<b>Verizon Level Security</b>

# Common Attributes of Cloud Services

Cloud Services		Descriptions and Recommended values of attributes
Resource	Virtual	Yes or No
	Physical	Yes or No
Network (i.e. NaaS)	Service Name	•
	Bandwidth	•
	Scheduled	•
	Shared	•
	Dedicated	•
	On-Demand	•
	Duration of Resource	•
	IPv4/IPv6 Address, VLAN and MAC Filtering	•
	NAT	•
	Firewall	•
	User Authentication	•
	Encryption	•
	Dynamic Scalability	•
	Billing	•
	Infrastructure (i.e. IaaS)	Service Name
CPU		•
Memory		•
Hard Disk Space		•
Dedicated		•
Shared		•
Scheduled		•
On-Demand		•
Duration of Resource		•

# IaaS: Cloud Computing

Cloud Computing Services		Descriptions and Recommended values of attributes
Service Name		Cloud Computing
Servers	Dedicated rack	
	Bare metal servers	Single processor, dual processors, quad processors, ...
	High Performance Computing, with protected SSD storage	
	Mass Storage Servers in GB or TB	floppy disks, hard disks, optical disks, or tapes
	Redundant Power Supplies	
	RAM in GB	
	Number of VMs supported	
Virtual Servers	Single-tenant host	
	Multi-tenant host	
	Cores	1,2,3,4,5,6,7,8,..vCPU
	RAM in GB	
	Storage in GB	SAN storage, local storage, portable storage

# PaaS Attributes

PaaS		Descriptions and Recommended values of attributes
Service Name		PaaS
Supported Programming Languages	List of Languages	•
Database		•
Support of multiple Operating Systems	List of OSSs	•
Servers		•
Security		•
NaaS attributes		•

# ETSI GS NFV 002 v1.1.1

---

- NFs are connected by logical links
- End points are connected to NFs via infrastructure resulting in a logical interface between end points and NFs

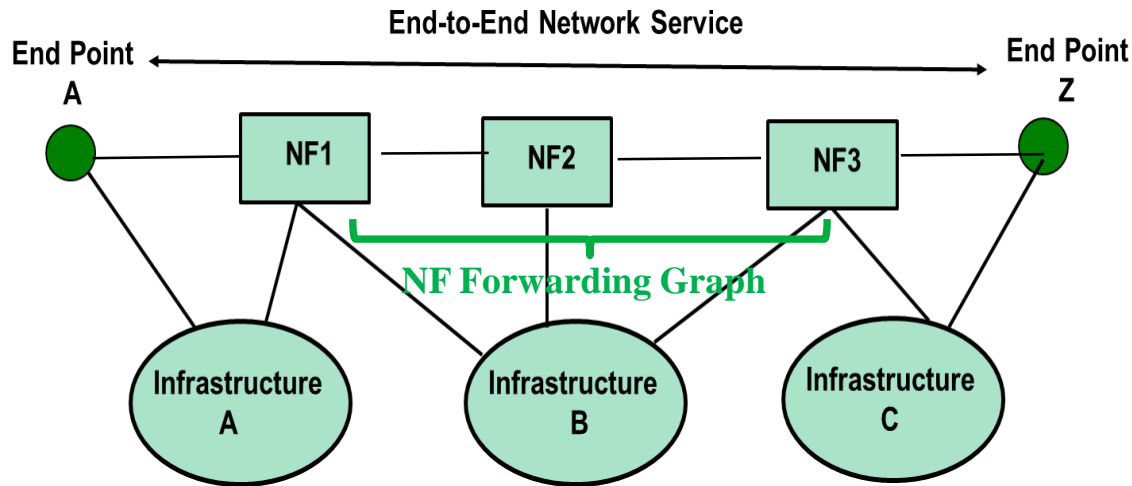

# ETSI GS NFV-SWA 001 V1.1.1 (2014-12)

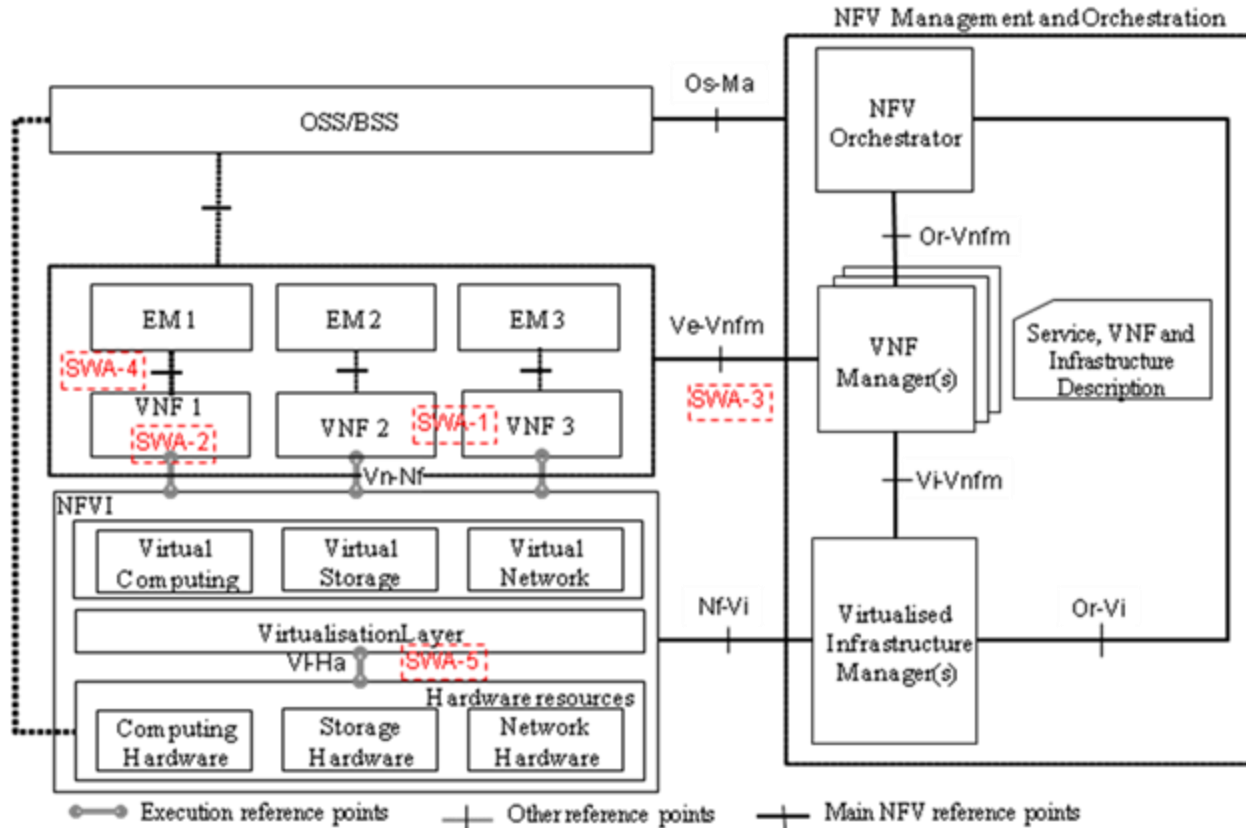

# ETSI GS NFV-SWA 001 V1.1.1 (2014-12)

- NFVI uses multiple, separate instances of the **SWA-5 (Vn-Nf)** interface to provide access to the hosted execution environment of each separate VNFC instance.

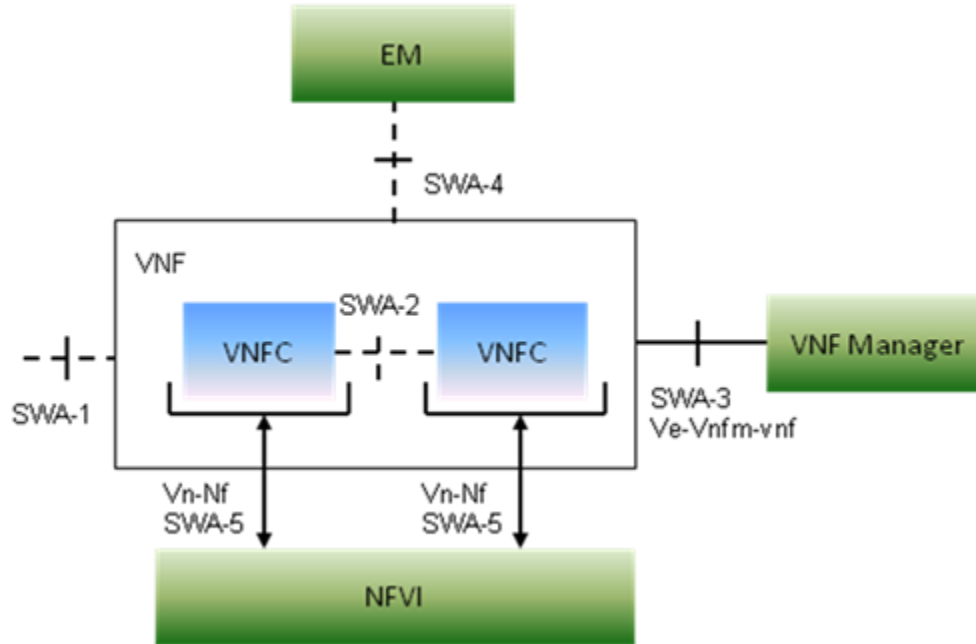



# SWA-1

- SWA-1 interface enables communication between various network functions within the same or different network service. They may represent data and/or control plane interfaces of the network functions (VNF, PNF). The SWA-1 interface is between two VNFs, a VNF and a PNF, or between a VNF and an End Point. A VNF may support more than one SWA-1 interface.

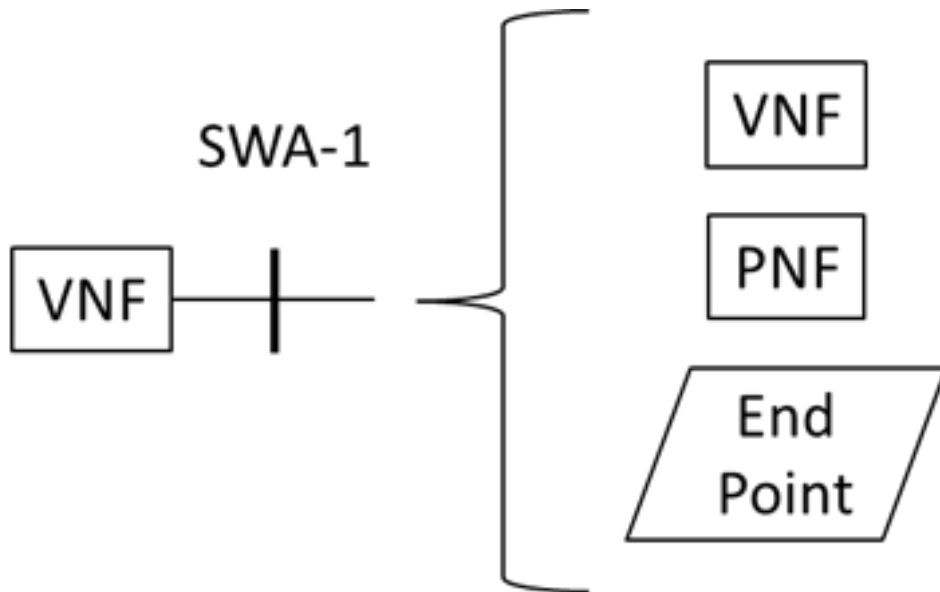

# NFV Reference Architectural Framework (ETSI GS NFV-INF 004 V1.1.1 (2015-01

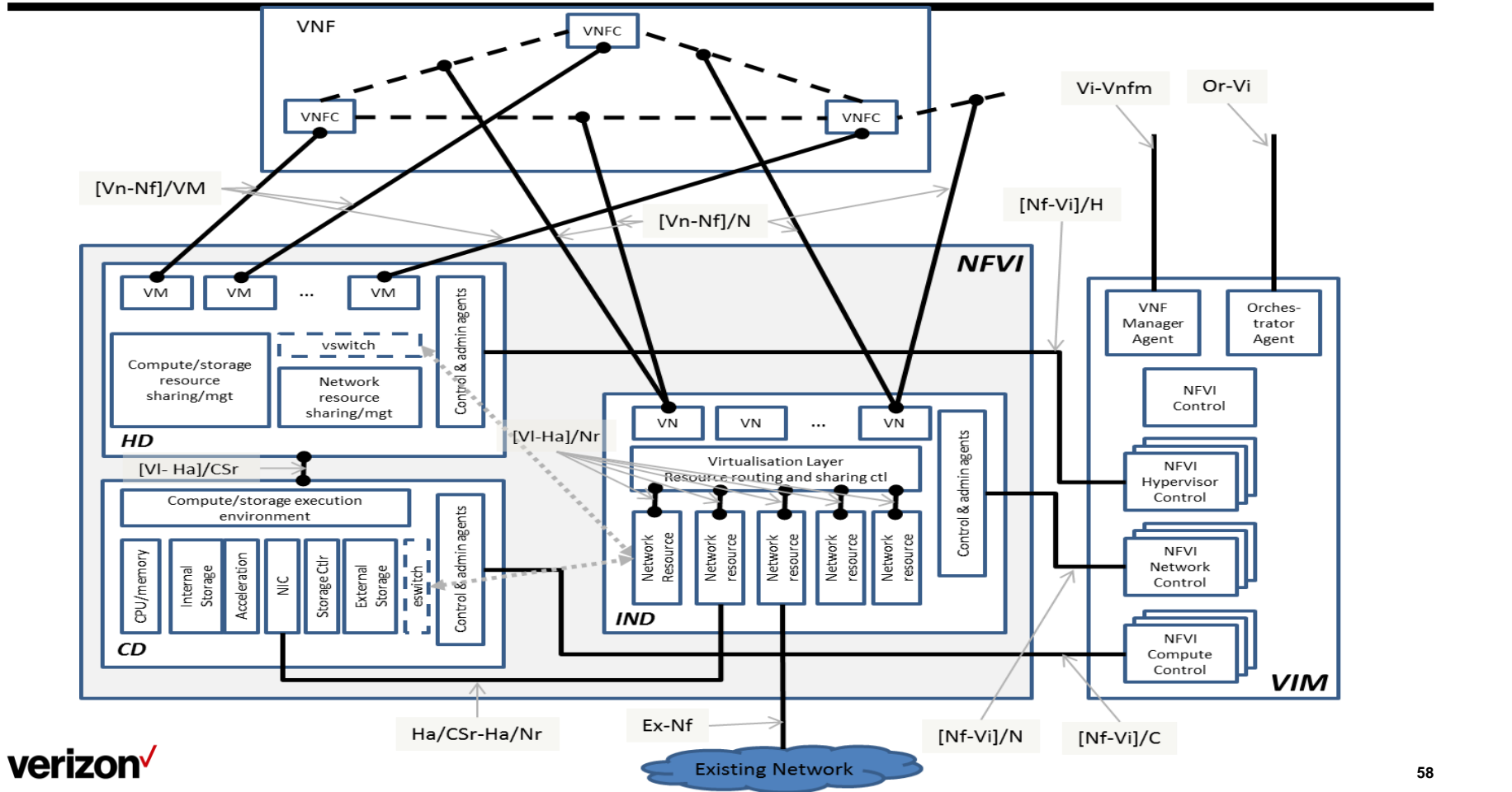

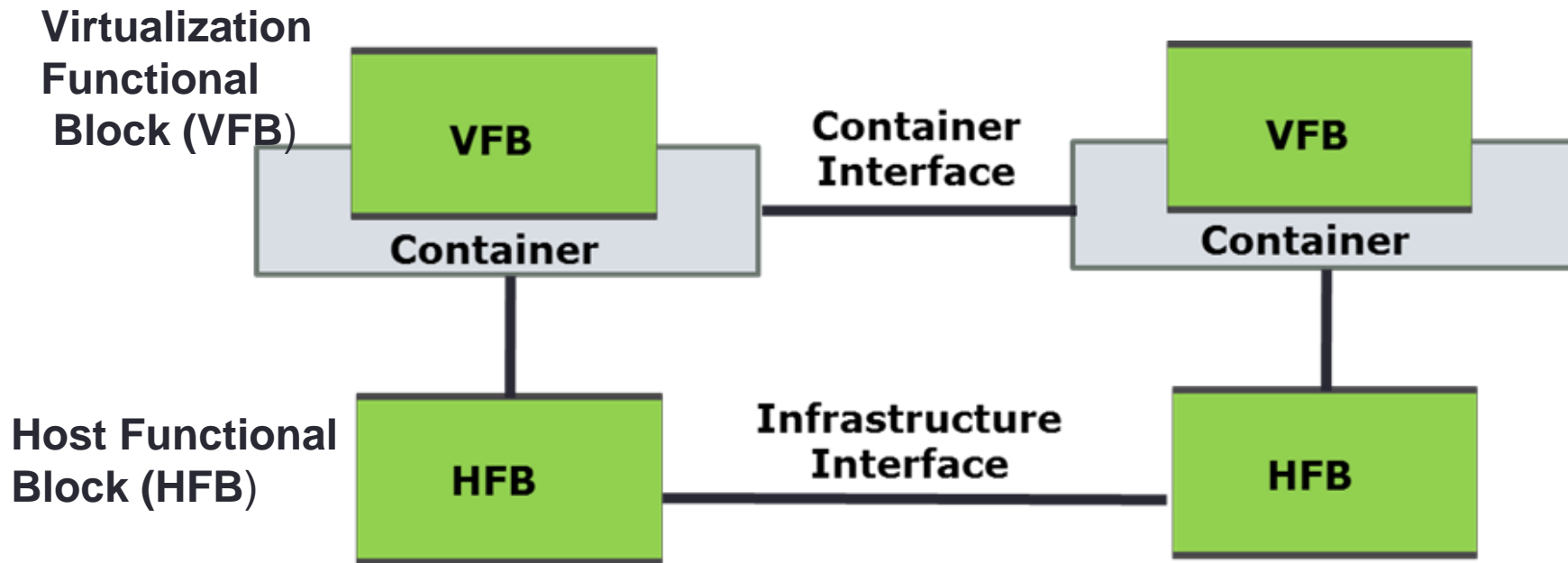

# Mapping

---

CSUI	<b>(Vn-Nf)+(VI-Ha)</b>	<b>NFV Reference Point Internal and External</b>
	<b>(Vn-Nf)/VM</b>	<b>VM Container Interface</b>
	<b>(Ha/CSr-Ha/Nr)</b>	<b>Interface between network infrastructure domain and the storage/server of the compute domain</b>

# Mapping

Architectural Construct	NFV Construct	Cloud Architecture Construct
User Interface	(VI-Ha)+(Vn-Nf)/VN, vCPE Interface, Infrastructure Interface, Ha/CSr-Ha/Nr	cSUI
VM Interface	(Vn-Nf)/VM	cI
Virtualized Network Container Interface between VNFC instances	(Vn-Nf)/N	cI
VM Container Interface	[Vn-Nf]/VM	cI
VN Container Interface	[Vn-Nf]/VN	cI
SWA-1, SWA-2, SWA-5	Software Architecture-1, 2,5	cI
Application Interface	vAPL Interface	cI
Cloud Carrier-Cloud Provider Interface		cSOcS
Cloud Provider-Cloud Provider Interface		cSOcS
Connection between Users or between a User and Virtual Platform or between Virtual Platforms or between a user and Application or between Applications	End-to-End Network Service	cSC
Connection End Point	End Point	cSCEP

# IFA022

- An **EvCPE (Enterprise vCP) service** is installed with VNF has two sites. The vCPE is in one site and the vAPL is in another site. The virtual link between the VNF is supported across a WAN

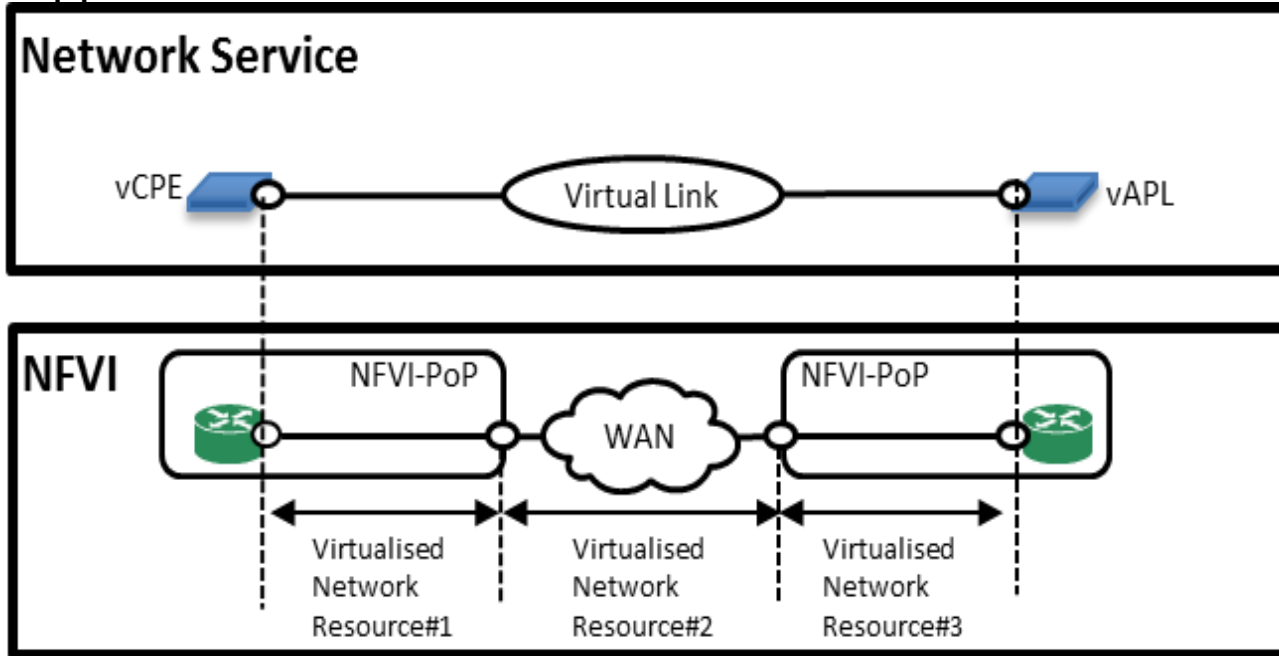

# Comments

---

- **An NFI-POP of a Service Provider is expected to include larger units than vCPE.**
- **At Customer premises, vCPE can be used. However, Cloud Service users can use a simple CPE with web browser to access Cloud Applications. The CPE does not have to be a vCPE.**
- **WAN can provide a Virtual Connection, but not a Virtual Link. Furthermore, VL can contain multiple connections.**

# IFA022: Parameters of NSD related to an E2E EvCPE service across WAN

Requirements of Virtual Link and Connectivity :  
 Bandwidth: 1Gbps~20Gbps  
 Latency: 10ms  
 Availability: Level 1

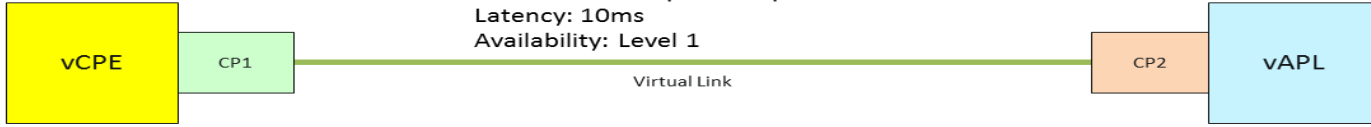

Network Service Descriptor	
Attribute	Content
vnfDId	"vCPE", "vAPL"
virtualLinkDesc	NsVirtualLinkDesc
nsDf	NsDf

NsVirtualLinkDesc	
Attribute	Content
virtualLinkDf	VirtualLinkDf
connectivityType	ConnectivityType

VirtualLinkDf	
Attribute	Content
qos	Latency "10ms"
serviceAvailabilityLevel	"Level1"

ConnectivityType	
Attribute	Content
layerProtocol	"Ethernet"
flowPattern	"Line"

NsDf	
Attribute	Content
vnfProfile	"VnfProfile1", "VnfProfile2"
virtualLinkProfile	VirtualLinkProfile
affinityOrAntiAffinityGroup	AffinityOrAntiAffinityGroup

VirtualLinkProfile	
Attribute	Content
maxBitrateRequirements	"10Gbps"
minBitrateRequirements	"1Gbps"

VnfProfile1	
Attribute	Content
vnfDId	"vCPE"
affinityOrAntiAffinityGroupId	"Affinity1"

AffinityOrAntiAffinityGroup	
Attribute	Content
groupid	"Affinity1"
affinityOrAntiAffinity	"anti-affinity"
scope	"NFVI-PoP"

VnfProfile2	
Attribute	Content
vnfDId	"vAPL"
affinityOrAntiAffinityGroupId	"Affinity1"



# IFA22: Object Classes & Attributes of NSD

---

- **vnfdId**
- **virtualLinkDesc**
  - **virtualLinkDf**
    - **qos**
    - **serviceAvailabilityLevel**
  - **connectivityType**
    - **layerProtocol**
    - **flowPattern**
- **nsDf**
  - **vnfProfile**
    - **vnfdId**
    - **affinityOrAntiaffinityGroupId**
  - **virtualLinkProfile**
    - **maxBitRateRequirements**
    - **minBitRateRequirements**
  - **affinityOrAntiaffinityGroup**
    - **groupId**
    - **affinityAntiaffinity**
- **Measurements of Virtual Link and Connectivity**
  - **Bandwidth**
  - **Latency**
  - **Availability**
-

# Comments

---

- **NSD attributes includes some attributes of VNF interface (i.e. cl) and some attributes of VL (i.e. partially cSC)**
- **Bandwidth Profile concept consisting of CIR, CBS, EBS, EIR, EBS, Delay, Jitter and Loss, should be used.**
- **Bandwidth Profile can replace MaxBitRateRequirements and MinBitRateRequirements**

A network connectivity endpoint is an endpoint attached to an NFVI-PoP administrated by the VIM. As represented by the example, it is considered that the **endpoint can be mapped onto a Network Gateway**. Such a network gateway can be addressed by an attribute, the networkConnectivityEndpoint of the NfviPop Information Element. This attribute is helpful for other NFVI-PoP or N-PoP to find the location of the network gateway instance

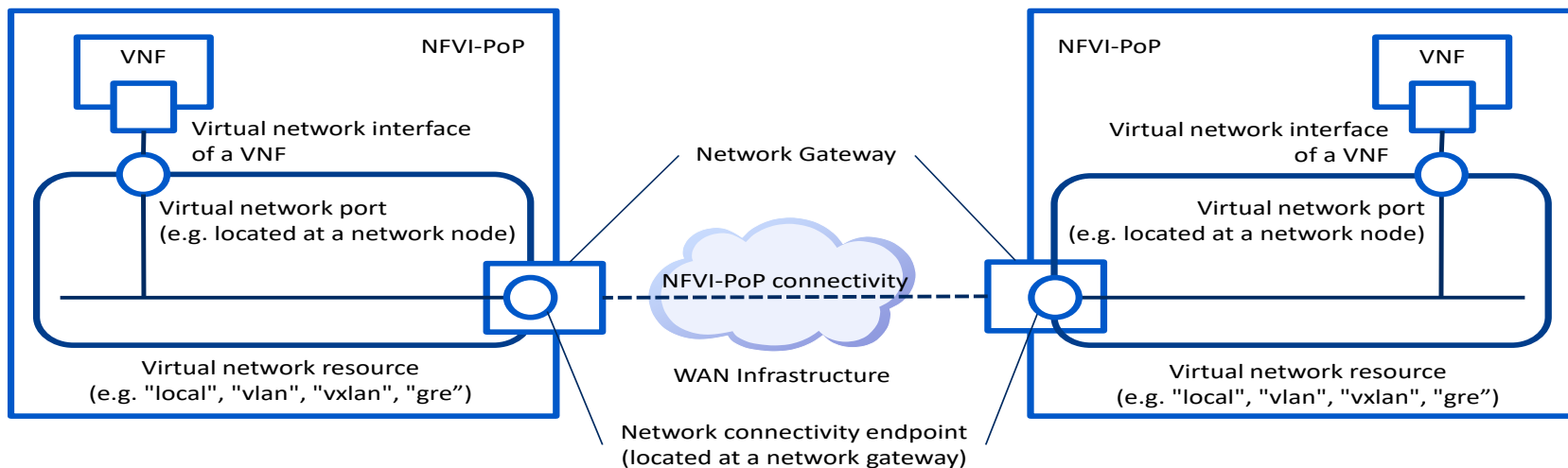

# IFA022

From the perspective of the infrastructure level, a network gateway of the NFVI-PoP is considered as a customer edge node (CE) [i.14] which connects branch sites. **The CE can be considered as an infrastructure node in the infrastructure network domain [i.4], or can also be a virtualised network node. On the other hand, PE nodes are put at the edge of the WAN infrastructure, interfacing to Ex-Nf, a reference point to an external network defined in NFV Infrastructure [i.4].** The connectivity at the WAN infrastructure level, called WAN connectivity, is established between the provider edge nodes. The connectivity may be configured in advance or on-demand. As shown in Figure 5.2.8-2, connectivity between the NFVI-PoPs, configured between the customer edge nodes, needs to be established over the WAN connectivity.

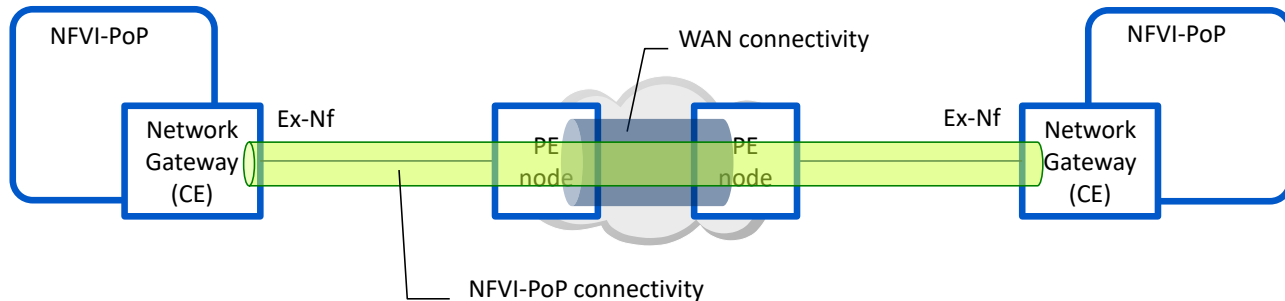

# Comments

---

- A GW Router is an example, not generic. The end point can be an Ethernet Switch.
- Ex-Nf is an internal interface for SP.

# Connectivity overview for enabling End-to-End Network Service across two WANs

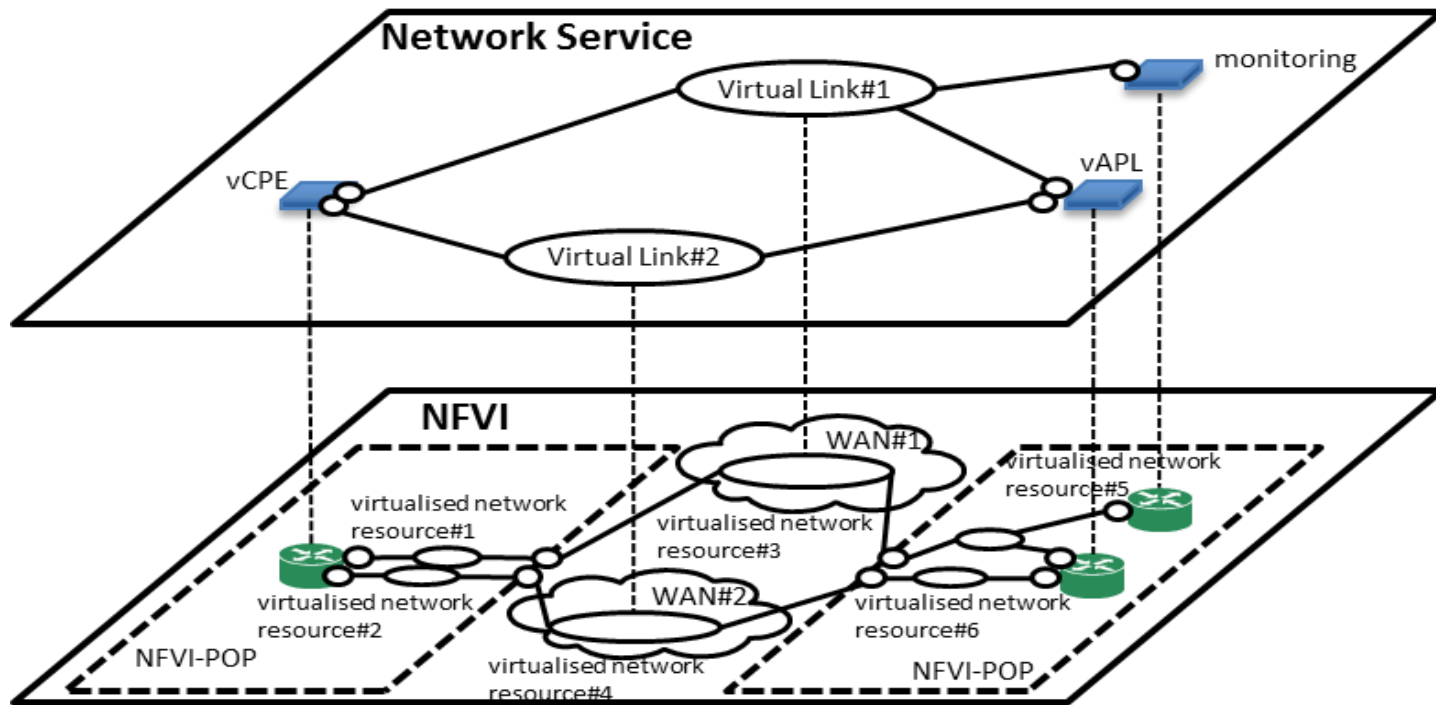

# Comments

---

- **This figure shows WANs of a Service Provider. Usually, the SP has one WAN with redundant paths.**

**Thank you.**