









# ONAP PNF Enhancements for Casablanca (R3, 4Q 2018) Casablanca Developer's Conference

- ONAP and PNF Plug and Play for 5G RAN
- 5G Use Case Team

# PNF Enhancements Casablanca Summary

TOPIC	ICON	DESCRIPTION
<b>PNF Registration Handler (PRH) Improvements</b>		New VES Event domain for PNF registration with corresponding support in VES collector, DMaaP and PRH.
<b>SO Workflow enhancements</b>		Introduction of dedicated 5G use case work-flow. Integration of PNF PnP workflow.
<b>Service Configuration Improvement</b>		Service configuration improvements from Controller to PNF after PNF registration to PRH
<b>Security Enhancements</b>		Enhancements for secure communications between NFs and ONAP and between ONAP components. Details will be covered in the Security Subcommittee presentation.
<b>Modeling enhancements</b>		Modeling enhancements to support 5G PNF in ONAP. Inheritance, and PNF characteristics for sharing. Focusing on PNF connectivity. PNF-SDK.
<b>PNF Onboarding / Package</b>		Defining <i>PNF Onboarding Package</i> . Extending framework to work with PNFs. Defining PNF Package framework.

# PNF Registration Handler (PRH)

## (1) New VES Event domain for PNF Registration

– Create new VES event domain *pnfRegistration* for PNF registration exchange

**(2) VES EXTENSIONS** - VES collector and VES agent field updates using the new domain. Extensions for PNF registration fields.

Corresponding VES Schema change (VES message 6.0 standard)

**(3) REQUIREMENTS PROJECT** – Requirements updates for PNF vendors to use the event.

**(4) PNF REGISTRATION EXCHANGE UPDATE** – The registration VES event will need to update its JSON payload.

**(5) AAF & PRH** – Intra-ONAP Security. PRH integration with AAF for security.

**(6) TOPIC CREATION** – Creation of new pnfRegistration DMaaP Topic. Topic needs to be pre-provisioned.

**(7) FAILURE HANDLING** – New registration PRH failure handling software.

**(8) SO INTEGRATION** – SO Work-flow Integration.



## PROJECTS

PNF Registration Handler, DMaaP, DCAE

# PNF PnP: SO Workflow Enhancements

## DESCRIPTION

### (1) SO WORKFLOW ENHANCEMENTS –

Dedicated 5G BTS Workflow in SO. (If not model-driven would need special 5G BTS workflow)

### (2) PNF WORKFLOW – Extensions to Beijing SO Workflow (part of VCPE workflow).

Developed in Beijing not tested or integrated.

### (3) MODEL DRIVEN – SO not yet model driven.

Will develop a SO work flow specific to service & resource use case.

### (4) UPDATE PNF WORKFLOW – needs to be officially tested, accepted (in Casablanca).

### (5) Controller TO SO INTERACTION –SO calls controller (Generic API call vs REST call)

### (6) DFX (Design for Excellence) – Resilience, Performance, Scalability, Stability, Multi-site.

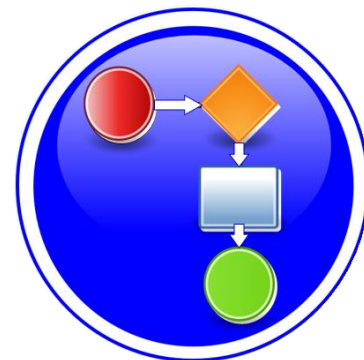

## PROJECTS

SO

# SERVICE CONFIGURATION ENHANCEMENT

## DESCRIPTION

- (1) **Service configuration Enhancements** to ONAP Controller to PNF *service configuration* exchange with PNF.
- (2) **PROTOCOL DEFINITION** – Better definition around the Protocols supported. What ONAP controller supports, which PNF are supported and what protocols are supported (NetConf, Ansible, Chef).
- (3) **Configuration Extensions** – New parameters needed for Casablanca use cases. Vid script to pushing data, ID config, ID where data comes from. Generic configuration support.
- (4) **PNF PnP Config** – Finishing Beijing PNF PnP by sending down config data.
- (5) **Vendor Data** – Extensions to Service Configuration with optional Vendor specific configuration data can be developed.



## PROJECTS

ONAP Controller (Controller), VID, SO, SDC/CDT

# SECURITY ENHANCEMENTS

## DESCRIPTION

**(1) SECURITY IMPROVEMENTS** – Enhancements for secure communications between NFs and ONAP and between ONAP components. Details will be covered in the Security Subcommittee presentation.



## PROJECTS

PNF Registration Handler, DCAE, AAF,  
ONAP Controller, DMaaP

# PNF PnP: MODELING ENHANCEMENTS

## DESCRIPTION

- (1) PNF MODELING** – Modeling enhancements to support 5G PNF in ONAP. Model Inheritance definitions for PNF. SDC modeling improvements from Beijing PnP use case.
- (2) PNF SHARING** – SDC model updates for PNF characteristics focusing on PNF inter-connectivity.
- (3) PNF-SDK** – SDK provided from Vendors. This will help modeling the Physical “Box” (PNF) and network functions.
- (4) CDT ENHANCEMENTS** - Improving CDT to handle complex config templates, multiple templates per PNF, identify different sources for template data, integrating CDT into SDC, expanding CDT usage to other controllers.



## PROJECTS

SDC, CDT, PNF-SDK

# PNF ONBOARDING / PNF PACKAGE

## DESCRIPTION

**(1) PNF PACKAGE DEFINITION** – Defining *PNF Onboarding Package*. Extending framework to work with PNFs. Defining PNF Package framework.

- A. PNF ARTIFACTS DEFINITION – Vendor specific/provided artifacts
- B. PNF ARTIFACTS DISTRIBUTION



### CONFIGURATION DEFS



### ALARM DEFINITIONS



### MEASUREMENT DEFS



### NF PACKAGE

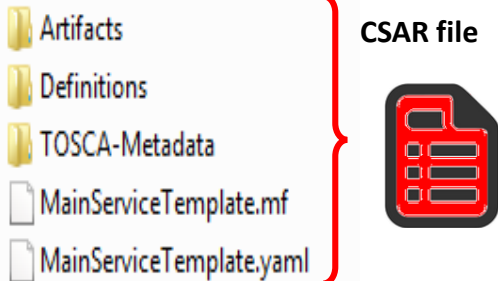

PROJECTS:  
SDC, APP-C





# PNF Plug and Play IN CASABLANCA (R3)

- ONAP and PNF Plug and Play for 5G RAN
- 5G Use Case Team

# PNF Plug and Play Stages

Design Time

A



## PNF Modeling

Resources Definition/Services Definition  
SDC: PNF (physical element) Modeling  
Distribution of types



B



## PNF Instance Declaration

PNF Infrastructure Service Declaration  
First part of PNF instantiation  
DCAE & AAI Entry with PNF ID (e.g. Serial Number)



C



## PNF Boot-strapping

PNF Powers up  
PNF performs a "Plug and Play" procedure  
Equipment vendor proprietary steps

D



## PNF Contacts ONAP

PNF connects to ONAP via a Registration Event  
PNF Registration Handler (PRH) processes the event  
Generic (not vendor proprietary)

E



## PNF Activation

Connection points configured  
Second part of PNF service instantiation  
PNF configured and ready to provide service

Run-Time (Instances)

# Design Time (ONAP)

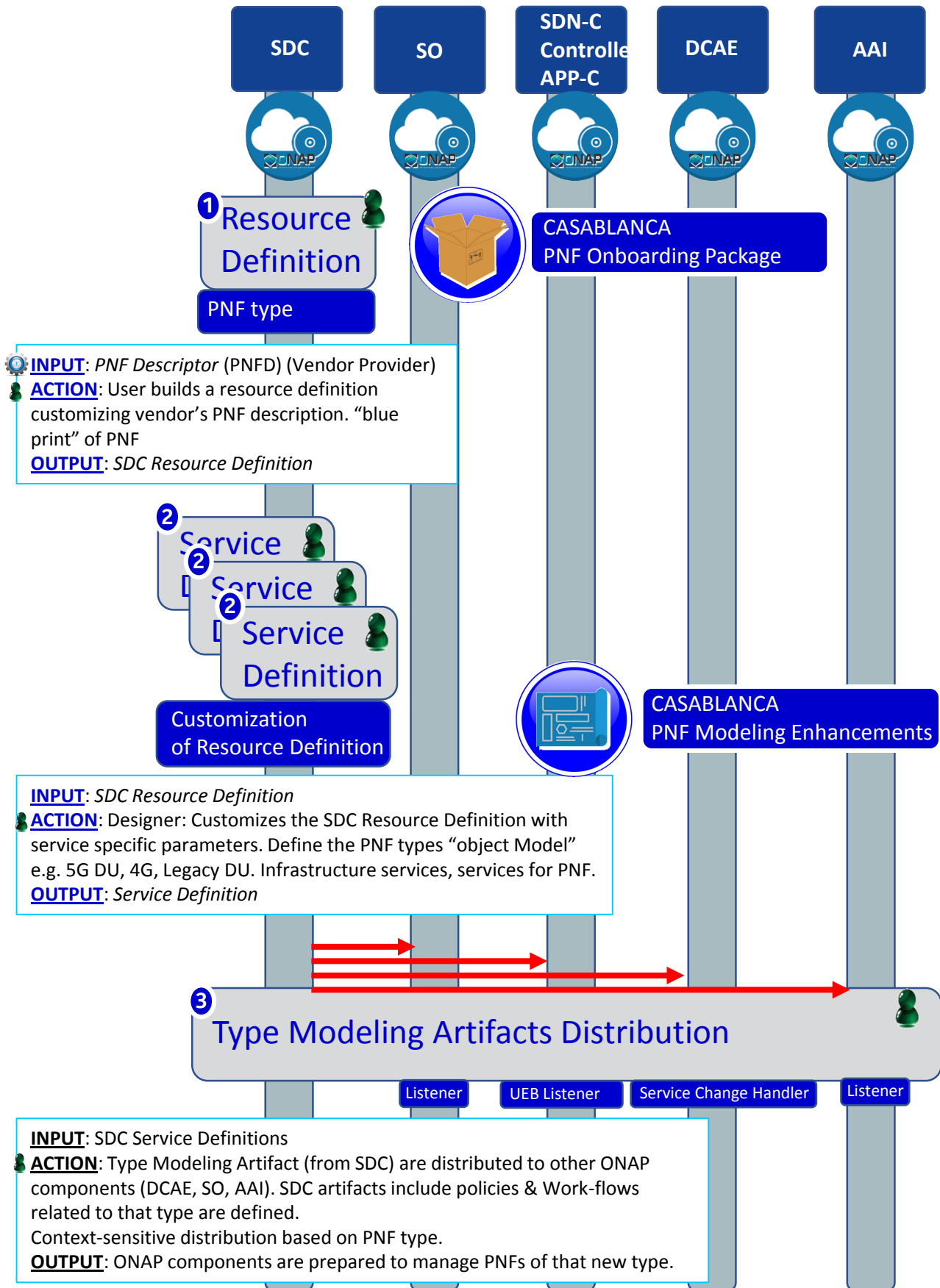

# PNF Plug and Play Steps (for 5G DU)

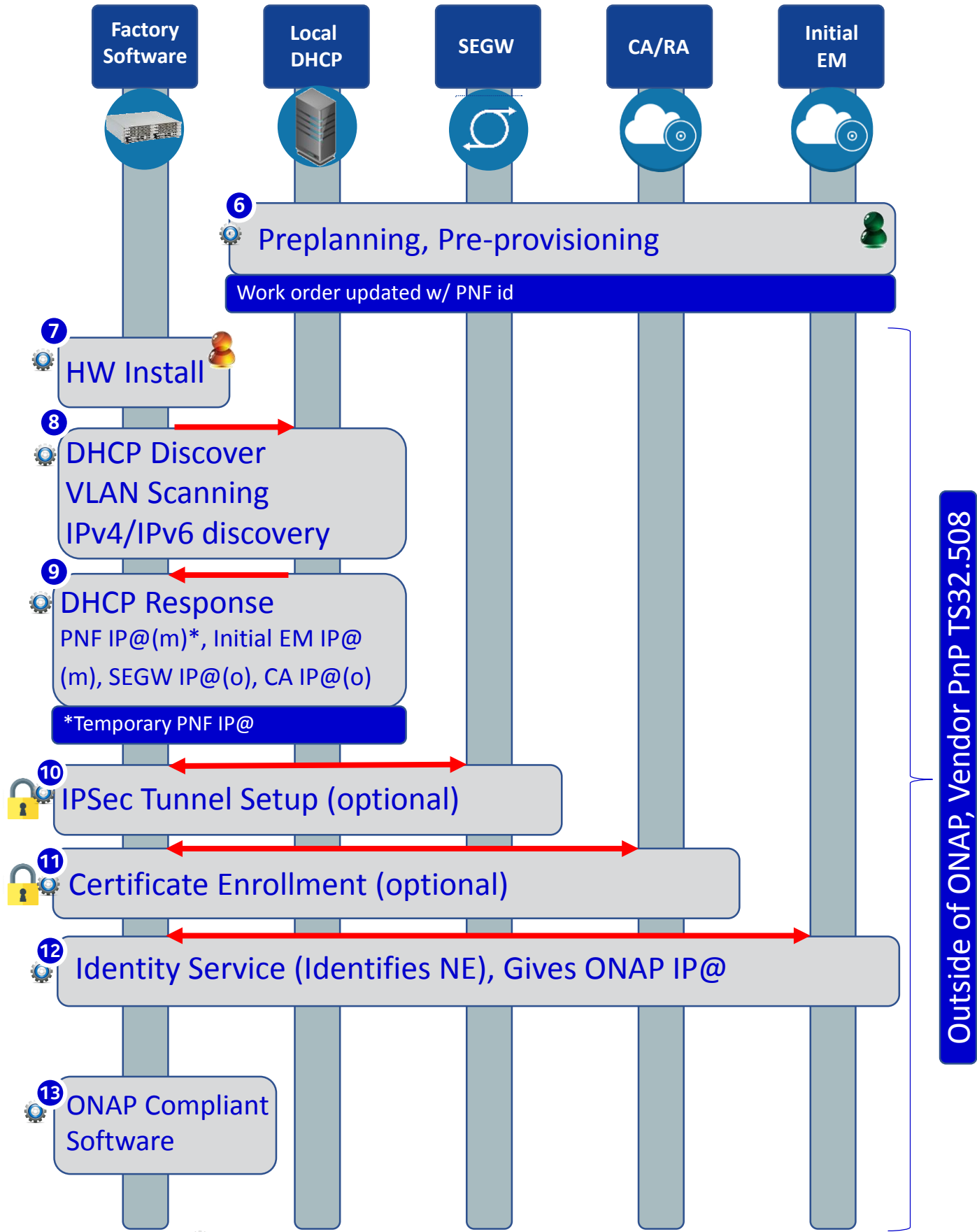

# Service Instantiation Process (Part 1)

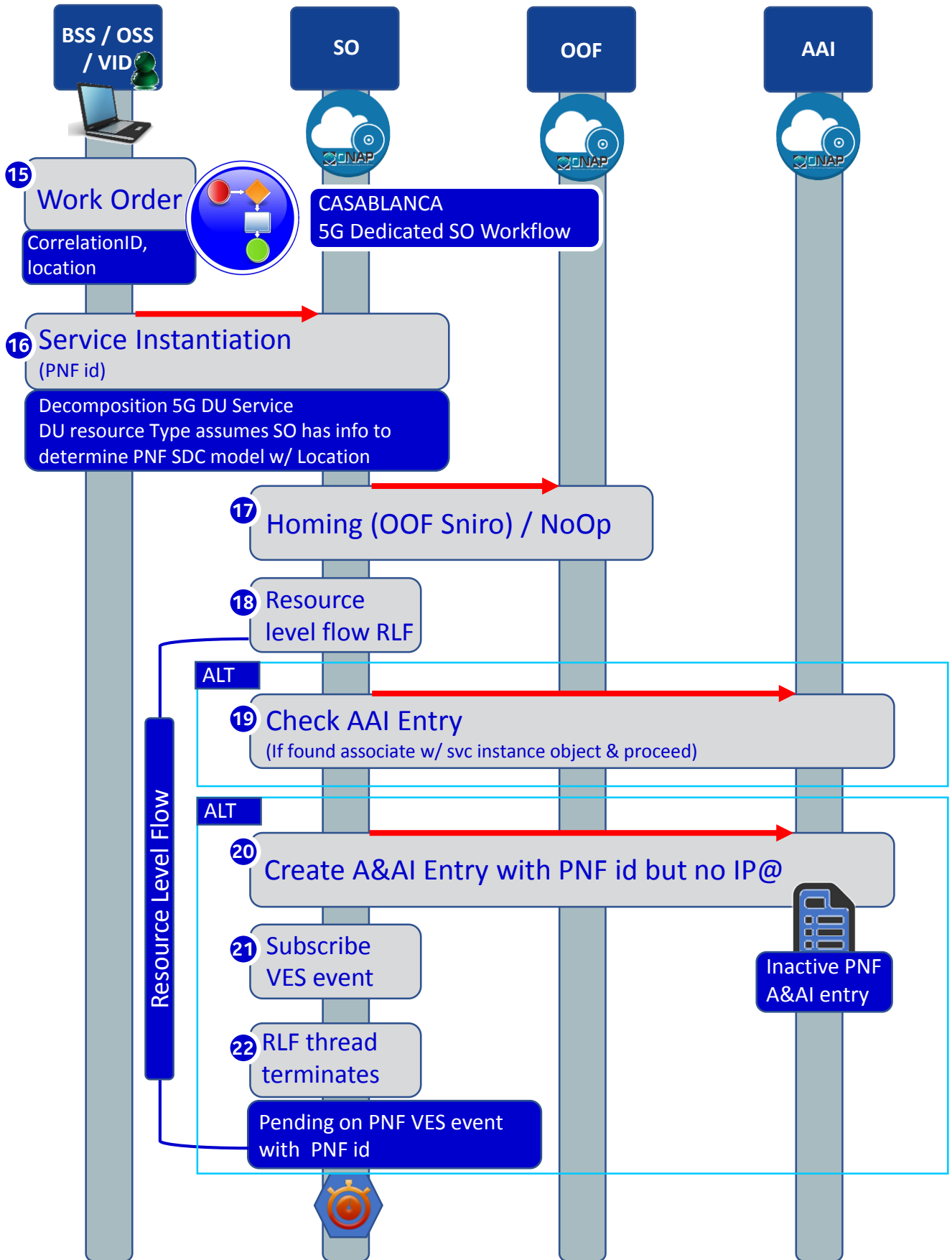

# PNF Registration Steps

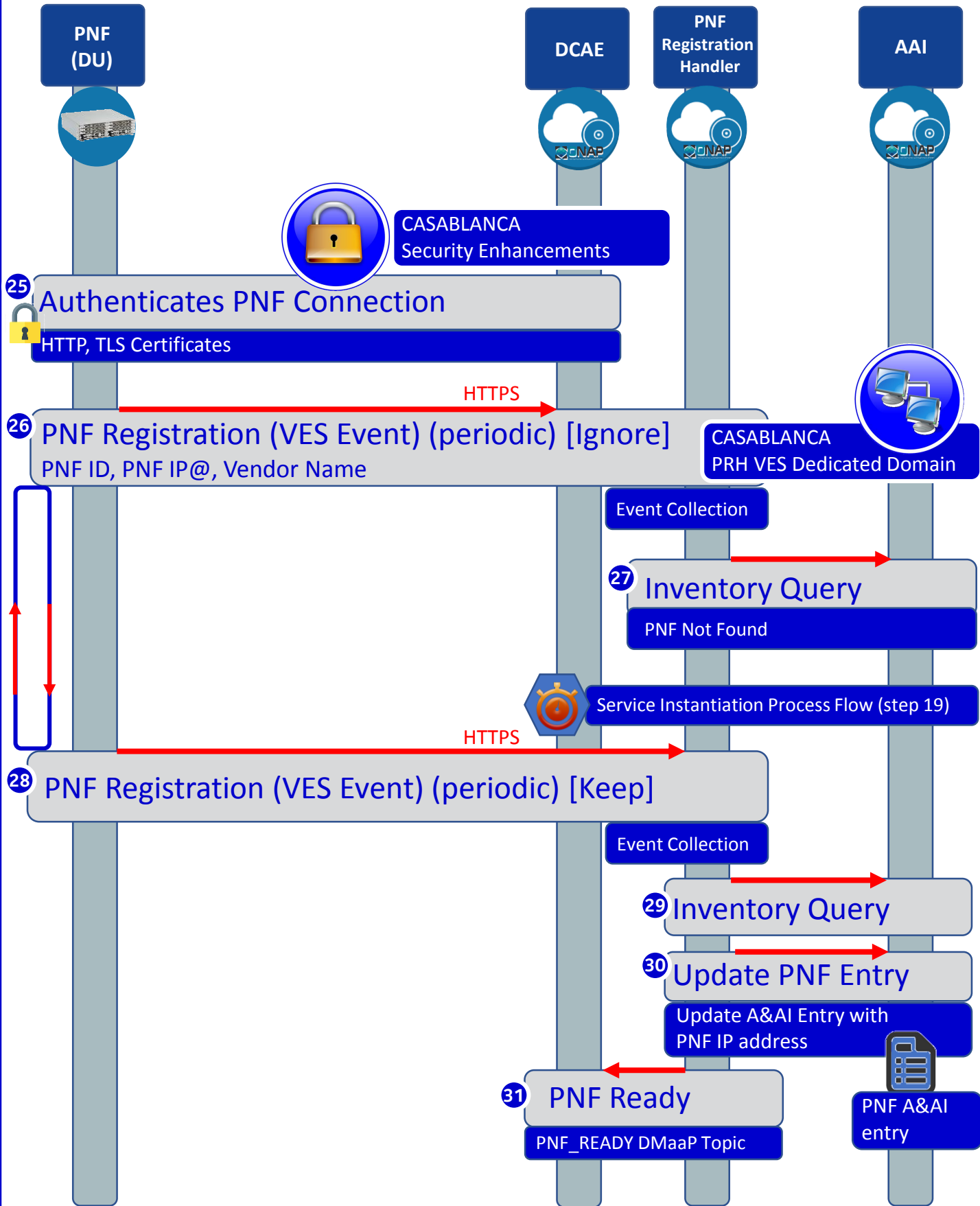

# PNF Activation Steps (ONAP)

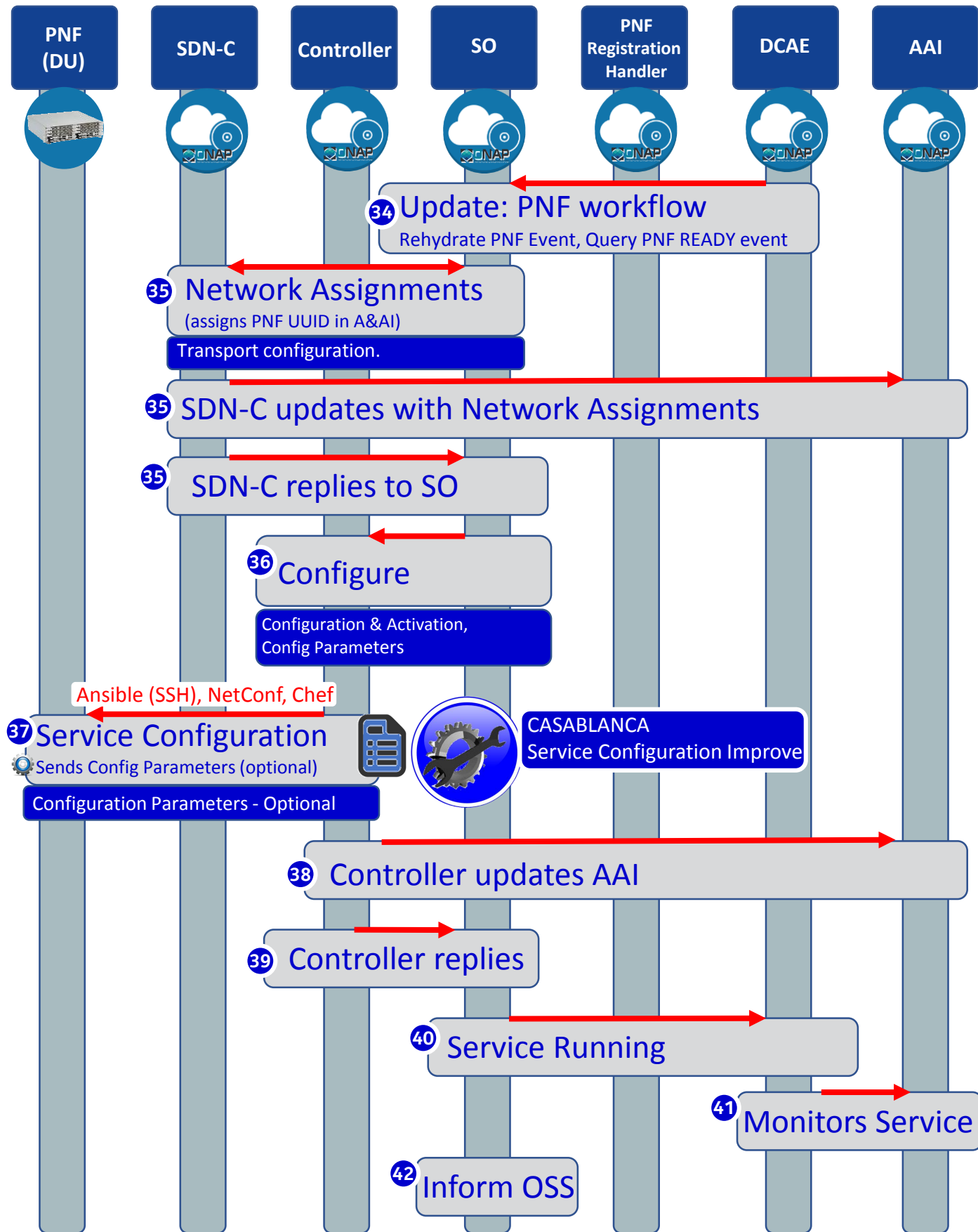

# PNF Final Download & Activation (Vendor Specific)



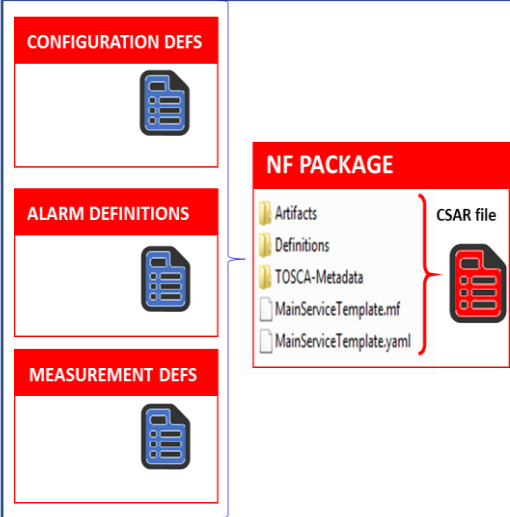

# PNF Vendor Requirements to support PnP

TOPIC	Step	DESCRIPTION
<b>PNF Package Artifacts and Dictionaries</b>	1	<p>NF Vendor needs To provide NF FM, CM, and PM artifacts to be onboarded to the PNF package during design time by SDC.</p> 
<b>PNF Descriptor</b>	1	<p>The “PNF-D” is a descriptor which provides detailed information about their PNF. This is used during design time to model the PNF.</p>
<b>Registration VES Event</b>	26, 28	<p>The PNF needs to support the new Registration VES Event. The PNF sends this event periodically to ONAP until the PRH finds the PNF AAI entry. The AAI entry is created in the SO Workflow.</p>
<b>Service Configuration</b>	37	<p>Once PRH has successfully found the PNF it can complete the registration process and it will have the ONAP controller send a service configuration message. Then it can stop sending the Registration event.</p>



# APPENDIX



**The complete PnP Use Case Slide Package can be found in the ONAP Wiki:**

<https://wiki.onap.org/display/DW/Use+case+proposal%3A+5G-+RAN+deployment%2C+Slicing%2C+SON>









# pnfRegistration VES Event





Field	Type	Required?	Description
version	number	Yes	Version of the event header (currently: 3.0) <b>3.0</b>
eventName	string	Yes	<b>pnfRegistration_vendor_pnfName</b> where <i>pnfName</i> is specified by the vendor and is a PNF type; e.g. <b>pnfRegistration_Nokia_5gDu</b>
domain	string	Yes	Event domain enumeration: 'fault', 'heartbeat', 'measurementsForVfScaling', 'mobileFlow', 'other', 'sipSignaling', 'stateChange', 'syslog', 'thresholdCrossingAlert', 'voiceQuality', ' <b>pnfRegistration</b> '
eventId	string	Yes	Event key that is unique to the event source <b>registration_yyyyyyyy</b> where <i>yyyyyyyy</i> is an integer starting at 0 and incremented by 1 for every pnfRegistration event sent by this PNF
eventType	string	No	<b>pnfRegistration</b>
nfcNamingCode	string	No	Network function component type: 3 characters (aligned with vfc naming standards) <b>Not used</b>
nfNamingCode	string	No	Network function type: 4 characters (aligned with vnf naming standards) <b>Not used</b>
sourceId	string	No	UUID identifying the entity experiencing the event issue (note: the AT&T internal enrichment process shall ensure that this field is populated) <b>Not used</b>
sourceName	string	Yes	Name of the entity experiencing the event issue <b>PNFid (unique PNF instance ID = PNF correlation ID = pnf-name stored in AAI ; e.g. NOK6061ZW3)</b>
reportingEntityId	string	No	UUID identifying the entity reporting the event, for example an OAM VM (note: the AT&T internal enrichment process shall ensure that this field is populated) <b>Not used</b>
reportingEntityName	string	Yes	Name of the entity reporting the event, for example, an EMS name. May be the same as the sourceName. For synthetic events generated by DCAE, it is the name of the app generating the event. <b>PNFid (unique PNF instance ID = PNF correlation ID = pnf-name stored in AAI ; e.g. NOK6061ZW3)</b>
priority	string	Yes	Processing priority enumeration: 'High', 'Medium', 'Normal', 'Low' <b>Normal</b>
startEpochMicrosec	number	Yes	the earliest unix time aka epoch time associated with the event from any component--as microseconds elapsed since 1 Jan 1970 not including leap seconds <b>current time</b>
lastEpochMicrosec	number	Yes	the latest unix time aka epoch time associated with the event from any component--as microseconds elapsed since 1 Jan 1970 not including leap seconds <b>current time</b>
sequence	integer	Yes	Ordering of events communicated by an event source instance (or 0 if not needed) <b>0</b>
internalHeaderFields	internalHeaderFields	No	Fields (not supplied by event sources) that the VES Event Listener service can use to enrich the event if needed for efficient internal processing. This is an empty object which is intended to be defined separately by each provider implementing the VES Event Listener. Empty <b>Not used</b>

# pnfRegistration VES Event



Field	Type	Required?	Description
pnfRegistrationFieldsVersion	number	Yes	Version of the pnfRegistrationFields block (currently: 1.0)
serialNumber	string	Yes	TS 32.692 serialNumber = serial number of the unit; e.g. 6061ZW3
vendorName	string	Yes	TS 32.692 vendorName = name of manufacturer; e.g. Nokia. Maps to AAI equip-vendor.
oamV4IpAddress	string	No <sup>1</sup>	IPv4 m-plane IP address to be used by the manager to contact the PNF. Maps to AAI ipaddress-v4-oam.
oamV6IpAddress	string	No <sup>1</sup>	IPv6 m-plane IP address to be used by the manager to contact the PNF. Maps to AAI ipaddress-v6-oam.
macAddress	string	No	MAC address of unit.
unitFamily	string	No	TS 32.692 vendorUnitFamilyType = general type of HW unit; e.g. BBU.
unitType	string	No	TS 32.692 vendorUnitTypeNumber = vendor name for the unit; e.g. Airscale. Maps to AAI equip-type.
modelName	string	No	TS 32.692 versionNumber = version of the unit from vendor; e.g. AJ02. Maps to AAI equip-model.
softwareVersion	string	No	TS 32.692 swName = active SW running on the unit; e.g. 5gDUv18.05.201.
manufactureDate	string	No	TS 32.692 dateOfManufacture = manufacture date of the unit in ISO 8601 format; 2016-04-23.
lastServiceDate	string	No	TS 32.692 dateOfLastService = date of last service in ISO 8601 format; e.g. 2017-02-15.
additionalFields	hashMap	No	Additional registration fields if needed, provided as key-value pairs.

STEP	DESCRIPTION
1	<p><b>RESOURCE DECLARATION</b> – A user on the VID performs a Resource Declaration. This uses the Service definition created in SDC. The user on the VID can define known information about the PNF. The user can (optional) provide the following information</p> <p><b>PNF RESOURCE Definition</b></p> <ul style="list-style-type: none"> <li><b>Resource Type</b> – Type of Resource. NEW type: PNF (pre-defined in SDC)</li> <li><b>NAME</b> – Name of the PNF type</li> <li><b>CATEGORY</b> – e.g. Infrastructure</li> <li><b>TAGS</b> – User-definable tags (default name of the PNF)</li> <li><b>DESCRIPTION</b> – Textual description</li> <li><b>CONTACT ID</b> – Designer (user of ONAP)</li> <li><b>VENDOR</b> – PNF Vendor (e.g. Nokia)</li> <li><b>VENDOR RELEASE</b> – Vendor release</li> <li><b>VENDOR MODEL NUMBER</b> – PNF Model value (link to A&amp;AI)</li> <li><b>EVENTS</b> – Monitoring Event definitions. Define design-time templates.</li> </ul>
2	<p><b>SERVICE Definition (uses a PNF)</b></p> <ul style="list-style-type: none"> <li><b>NAME</b> – Name of the Service (mandatory)</li> <li><b>CATEGORY</b> – e.g. Network L1...L4, VOIP call Control, Mobility</li> <li><b>TAGS</b> – User-definable tags (default name of the PNF)</li> <li><b>DESCRIPTION</b> – Textual description of service (mandatory)</li> <li><b>CONTACT ID</b> – Designer (user of ONAP) (mandatory)</li> <li><b>PROJECT CODE</b> – ID (mandatory)</li> <li><b>Ecomp-Generated Naming</b> – Name</li> <li><b>Naming Policy</b> – Policy to be used to assign a name to a service by SO/SDNC</li> <li><b>SERVICE TYPE</b> – Type of service</li> <li><b>SERVICE ROLE</b> – The Role of this service.</li> <li><b>ENVIRONMENTAL CONTEXT</b> – distributed environments</li> <li><b>Specific Service</b> – PNF, allotted resource from a CU Service</li> </ul>
3	<p><b>DISTRIBUTION</b> – Event Monitoring Templates distributed.</p>



STEP	DESCRIPTION (Plug and Play Vendor steps for Infrastructure components)
6 	<b>PRE-PLANNING, PRE-PROVISIONING</b> – There is data which is programmed into the system for the PNF Plug and Play operation. The user programs information which will be used by the PnP Use Case into ONAP.
7 	<b>HW INSTALL</b> – The physical hardware is installed at the site. Site licensing, real estate contacts, zoning, and physical hardware of the PNF is installed by technicians. Power, backhaul, and antennas are installed and connected.
8 	<b>INITIAL NETWORK ACCESS</b> – A DHCP Discover procedure is executed when the PNF powers on, VLAN Scanning is performed, and IPv4/IPv6 discovery is done. The DHCP Discover message exchange provides an entryway into the network and is designed as an procedure for a network element to be able to find connection to the network from “scratch”. VLAN Scanning and IPv4 vs IPv6 discovery is done as well.
9 	<b>DHCP RESPONSE</b> – The DHCP response returns a PNF IP address, the initial EM IP address, Security Gateway IP address (optional), and certificate authority IP address.
10 	<b>IPSEC TUNNEL</b> – An IP Sec Tunnel is established which uses cryptography to provides a secure connection.
11 	<b>CERTIFICATE ENROLLMENT</b> – The process where the PNF gets a service provider certificate from the Certificate authority.
12 	<b>IDENTITY SERVICE</b> – The identity service is there to identify the PNF. It also returns the ONAP (DCAE) IP address.
13 	<b>ONAP COMPLIANT SOFTWARE</b> – The PNF contacts the initial EM and downloads the ONAP Bootstrap software. This is a software package that is meant to perform the remaining steps of PNF registration and activation onto ONAP
14 	<b>PNF RESET</b> – The PNF is reset so that the downloaded ONAP Bootstrap software becomes activated and is then ready to continue to PNF registration

#	DESCRIPTION
15	 <b>WORK ORDER</b> – The work order determines which PNF to use for this Service/work order. BSS is told the PNF id.
16	<b>SERVICE INSTANTIATION</b> – The user on the VID creates a service instantiation providing a PNF id. The service is decomposed for a 5G DU PNF.
17	<b>HOMING</b> – The SO instantiation is homed with the OOF. Dependencies stated on PNF. The homing latency constraints are based on CPE address (location).
18	<b>RESOURCE LEVEL FLOW (RLF)</b> - The resource level flow thread starts. This thread is responsible for carrying out the creation of an A&AI entry in the following steps (steps 18 through 21).
19	<b>CHECK A&amp;AI ENTRY</b> – The RLF thread in SO checks the A&AI entry for the PNF. If SO discovers that there is an A&AI entry with both the PNF ID and the PNF IP@ then it can continue. If found it can associate it with the service instance.
20	<b>CREATE A&amp;AI ENTRY</b> – A&AI entry created by SO for PNF using the available information and the PNF id. This is done in anticipation of the PnP PNF VES event.
21	<b>CREATE DMaaP TOPIC LISTENER</b> – The RLF thread (process) subscribes to the DMaaP Topic that will complete the service instantiation. It allows ONAP to intercept the VES event that will eventually come from the PNF when it reaches a point in the PNF Plug and Play process that it is ready to contact ONAP.
22	<b>RLF THREAD TERMINATES</b> – The Resource Level Flow (RLF) thread in SO terminates. When the VES event is received at a later point in time, it can be processed accordingly. Additionally, the  steps 15-22 prepare ONAP with the pre-requisite information so that when the VES event comes from the PNF it will not be discarded. This is denoted by stopwatch icon  . At a later step in the PNF Plug and Play this thread becomes relevant again at the other stopwatch icon  .



STEP	DESCRIPTION
23	<b>DHCP Request</b> –ONAP Onboarding S/W performs a DHCP procedure with vDHCP
24	<b>DHCP Response</b> – DHCP response returns a ONAP IP address
25	<b>Authenticate PNF</b> – The PNF is authenticated through a vAAA.
26 & 28	 <b>PNF DISCOVERY</b> – The PNF <b>periodically</b> generates a <b>VES Event (json schema extend for discovery event)</b> to DCAE which is the “triggering” event that tells ONAP that the PNF is trying to register.
27 & 29	 <b>INVENTORY QUERY</b> – PNF Registration Handler performs an inventory Query to A&AI using the PNF id (based on the PNF ID) as the key. The AAI instance for this PNF ID must have already been created. If it has, then this is a valid, expected PNF. If not, then this is not a valid or not found a response is given to the PNF. In Step 32, PNF A&AI entry is found.
30	<b>UPDATE PNF ENTRY IN AAI</b> – The PNF entry in AAI is updated with the PNF IP address. After this step, the PNF is considered to be active in ONAP and becomes available as an network element to fulfill service requests.
31	<b>PNF READY</b> - PRH publishes a PNF Ready event on the DMaaP bus to which SO subscribes. SO receives the PNF Ready event, determines that it is an event it is waiting for and rehydrates the appropriate RLF to restart the Service Instantiation
(15-22)	<b>SERVICE INSTANTIATION PROCESS (PART 1)</b> – Steps 15-22, the Service Instantiation Process (part 1) occurs in <b>parallel</b> to these steps. When that process reaches the pending point (denoted by  ) it rejoins the flow here. PNF previously declared.
32	<b>PNF DISCOVERY RESPONSE</b> - The PRH responds to the PNF discovery event of the PNF with a response.

STEP	DESCRIPTION
34	<b>SO NOTIFIED</b> - PNF Infrastructure Manager Notifies SO. SO listens to the DMaaP hook. A trigger. Wait for PNF onboarded. Calls SDN-C.
35	<b>NETWORK ASSIGNMENTS</b> – SDN-C assigns an IP Address for PNF. <b>AAI UPDATE</b> – SDN-C updates AAI from assignments <b>SO NOTIFY</b> – SDN-C notifies SO
36	<b>ACTIVATE</b> – Configuration & Activation of the PNF Depends on the resource type. The controller requires input data based on PNF type.
37	 <p><b>SERVICE CONFIGURATION</b> – APP-C calls Ansible to configure PNF’s (Configuration Parameter) NetConf messages from SDN-C to PNF.</p> <p>(1) <b>Configuration Parameter (optional)</b> – Controller/APP-C gives the Controller IP@ to the DU. In R3, Controller/APP-C may pass configuration parameter(s) to the 5G DU, this will also give a configuration parameter (e.g. CU IP@).</p> <p>(2) <b>OAM IP@ (optional)</b> - The permanent OAM IP address is given to the PNF. The IP address assigned from SDN-C may come from the vAAA, or it may draw from a local pool of IP addresses. SDN-C performs the IP address selection. It knows if a permanent IP address should be assigned to the PNF. Note: this IP@ assignment <i>optional</i>.</p> <p>(3) <b>Transport configuration (optional)</b> – Transport configuration is given to the PNF.</p> <p>(4) <b>Location (optional)</b> – the Location configuration may be given to the PNF.</p> <p>(5) <b>Software Version (optional)</b> – In Casablanca it could be specified a Software Version.</p>
38	<b>SDN-C Updates A&amp;AI</b> – SO updates A&AI with Network Assignments (from step 35)
39	<b>SDN-C replies to SO</b> – SDN-C replies to SO are the service configuration step.
40	<b>Service Running</b> – SO publishes a “Service running” event to which DCAE subscribes.
41	<b>Monitors Service</b> - DCAE reads A&AI entry and sets up monitoring for the new service. DCAE publishes “Service monitored” event to which SO subscribes.
42	<b>OSS Inform</b> - SO responds to User/BSS/OSS that the service is active.

STEP	DESCRIPTION
42 	<b>CONNECTION TO CONTROLLER</b> – The DU makes contact with the CU.
44 	<b>CU CONFIGURES DU</b> – The configuration information is downloaded to the DU.