



Input for ONAP Architecture and Modeling Workshop SP Survey Report for ONAP & ESTI NFV Alignment

Lingli Deng, China Mobile
2018/10/29

Motivation

Purpose: to collect information and derive requirements for accelerating ONAP adoption.

Survey Scope:

- **Adoption Strategy** : Would you adopt ONAP as a whole or incrementally? If incrementally, what are the key components to start with?
- **ETSI NFV Alignment** : Do you require ETSI NFV alignment in your adoption? What are the components/interfaces that are relevant to enable the desired alignment?

Survey questions sent out to totally **12** service providers (either via email or F2F during ONS EU 2018), including **10** Platinum SP members, **2** sliver SP members.

9 of 12 SPs graciously shared with us their feedback.

Part-1 ONAP Adoption Strategy (1/2)

Q8 : Are you plan to adopt ONAP based solution? If yes, would you adopt ONAP as a whole or incrementally?
If no, what is the blocking technical issue? How would ONAP do to help?

Adopt ONAP based solution(5)

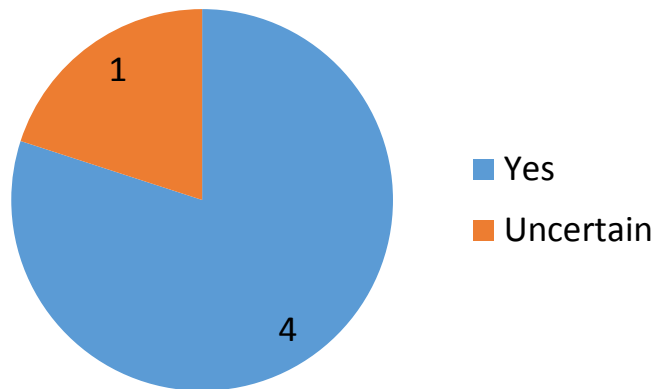

Adopt ONAP Incrementally(4)

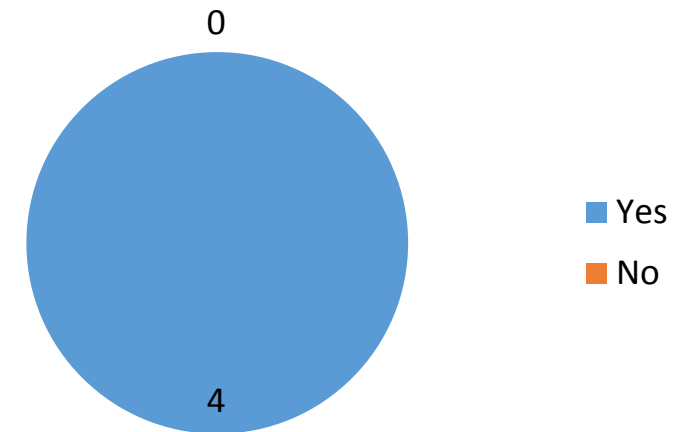

5 SPs provided clear positioning in the ONAP Adoption Strategy.

- **1 operator is uncertain whether to deploy ONAP.**
- **4 operators will adopt an incremental deployment strategy.**

Part-1: ONAP Adoption Strategy (2/2)

Q9 : If you plan to adopt ONAP incrementally, what are the modules that you plan to adopt first?
Would the current status of these modules ready for commercial product development?
Would you do it yourself or asking the vendors to provide the compliant solution?

Key ONAP Modules

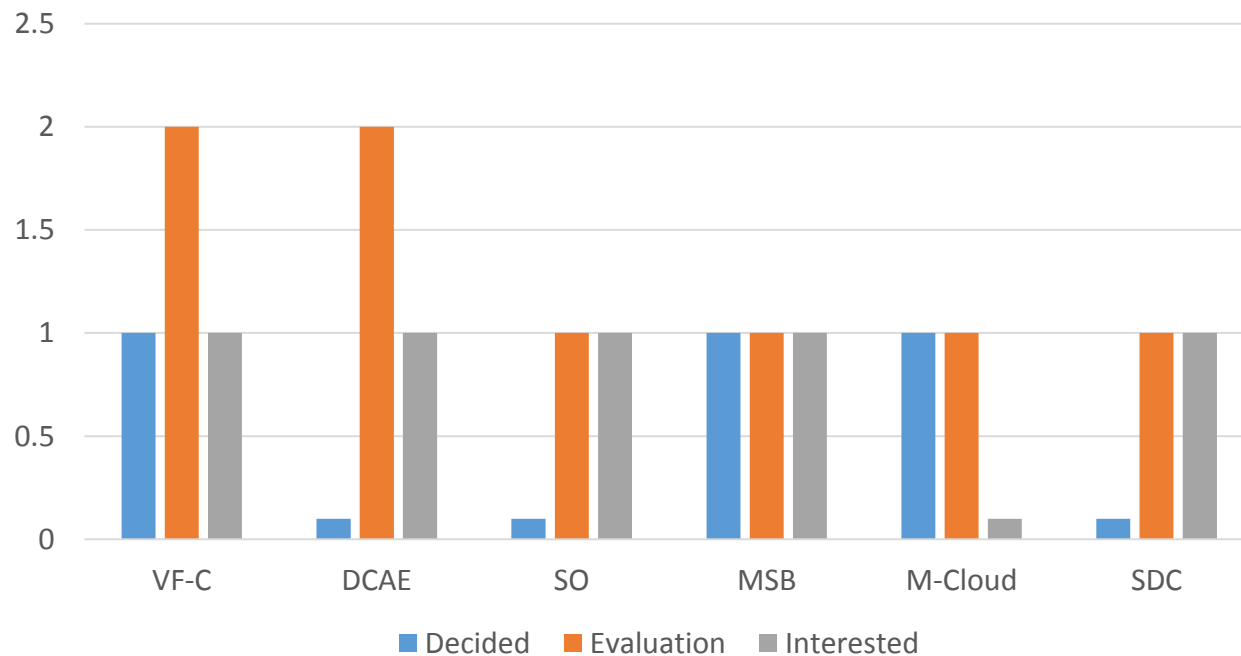

VF-C, MSB and M-Cloud are already used in one NFVO solutioning.

VF-C and DCAE attracts the most interest.

SDC and SO also in the pipeline.

Not ready for S3P.

2 Collaborative development approach.

Learnings from ONAP Adoption Strategy

- ONAP is a platform which should provide flexibility for SPs to allow them choose its own incremental deployment approach
- To start with, ONAP should focus on accelerating adoption of VF-C, DCAE, MSB, SDC, SO and M-Cloud.

Part-2: ETSI NFV Alignment Questions

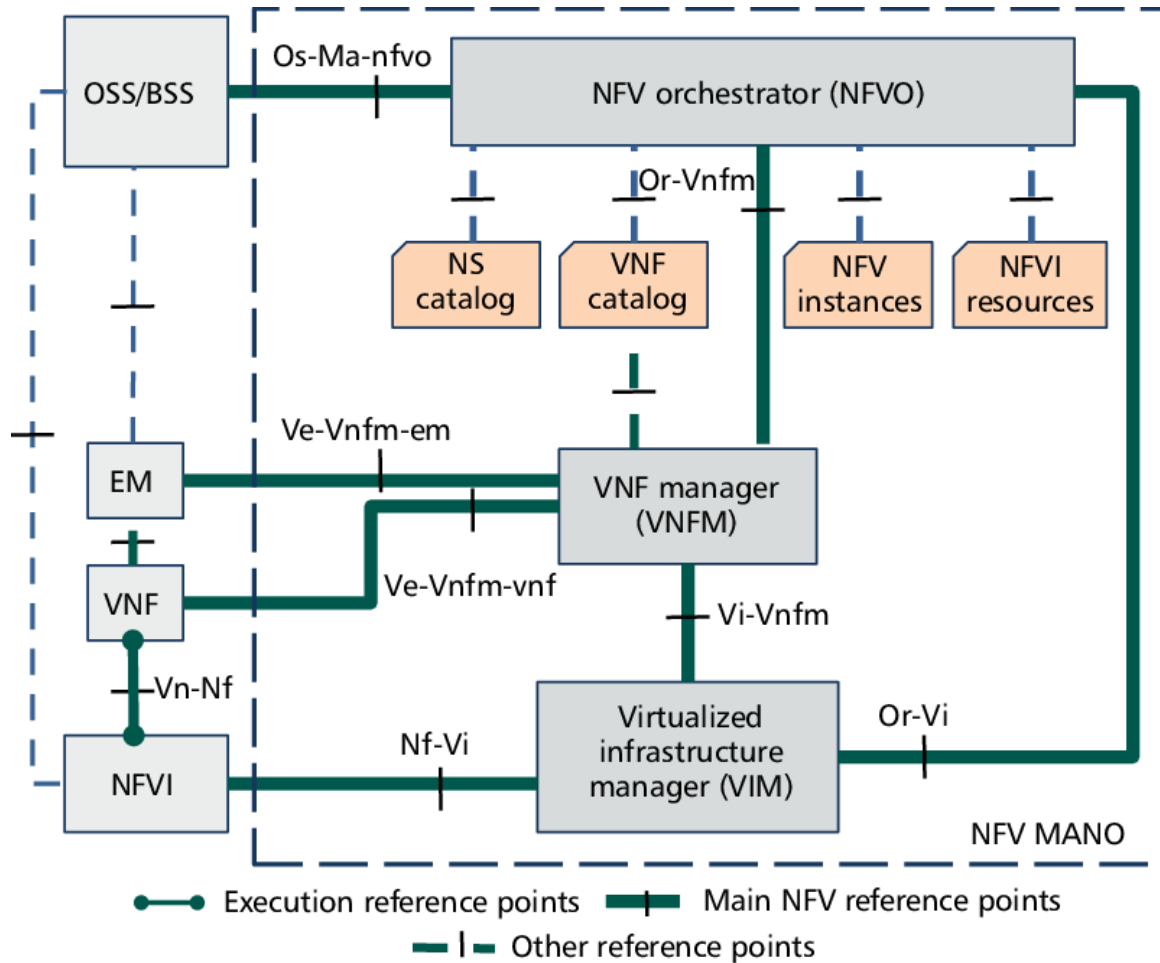

- ONAP to be able to function as part of the MANO stack?
 - NFVO? VNFM? Both?
- ONAP to be able interact with external MANO components?
- What are the interfaces and models relevant to enable such alignment as required?

Part-2A ETSI NFV Compliant Solution Adoption

Q1: Have you already deployed NFVO which is based on ETSI NFV reference architecture?

Q2 : If not, do you plan to deploy NFVO in the future?

Q3 : Do you plan to deploy VNFM only without NFVO?

Q6: Do you expect your NFVO could connect with OSS/BSS directly?

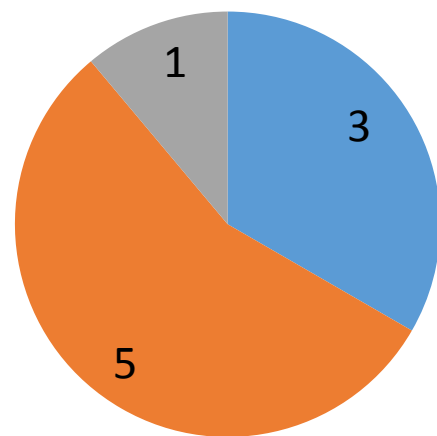

NFVO deployment (9)

■ Already have
■ Plan to
■ No demand

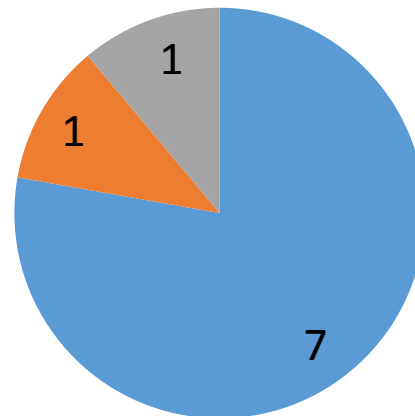

VNFM only deployment (9)

■ Yes
■ No
■ Maybe/It depends

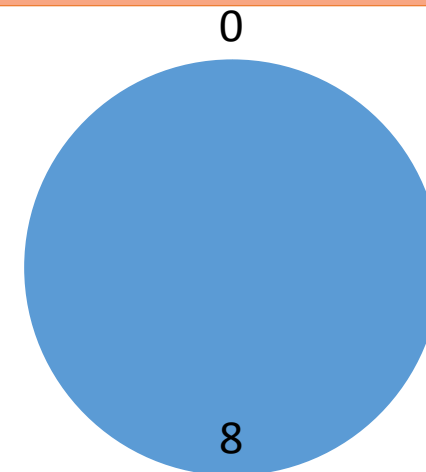

NFVO OSS/BSS interaction (8)

■ Yes
■ No

100% service provider have deployed ETSI NFV Compliant Solution (including either NFVO or VNFM).

8 among them have requirements to deploy NFVO, and expect their NFVOs to directly connect with OSS/BSS.

Only **1** has VNFM only deployment demand.

Part 2B: ONAP & NFVO Deployment Mode

Q4 : If you plan to have a NFVO, do you expect that it will plug in with ONAP or merge into ONAP?

Q5 : Do you want your NFVO to be interacted with other ONAP modules like SDC/A&AI/DCAE?

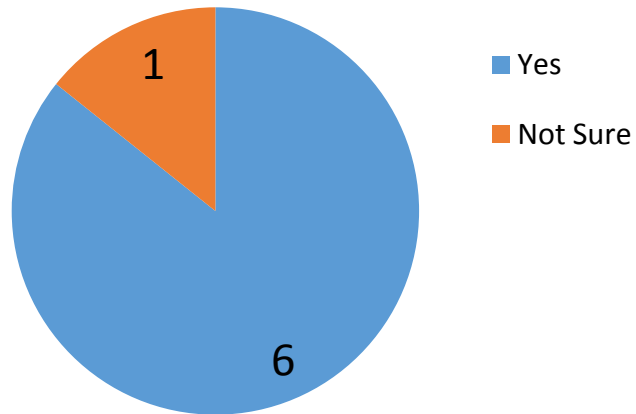

NFVO + ONAP Deployment (8)

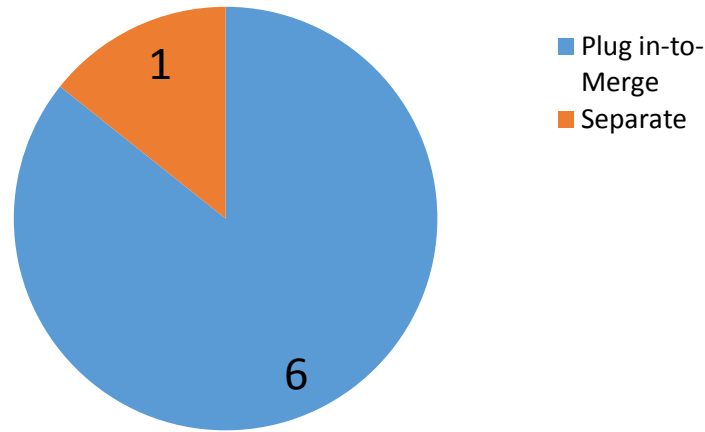

NFVO v.s. ONAP Integration (7)

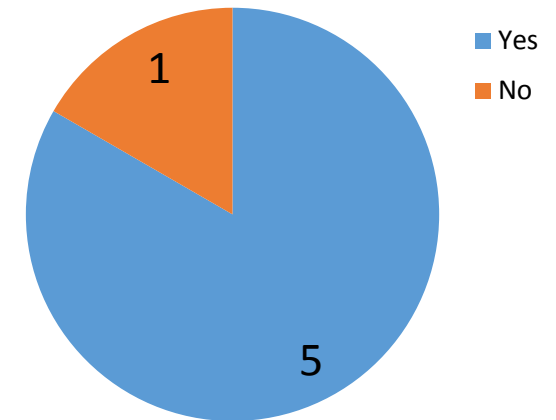

Plug-in NFVO with SDC/AAI/DCAE(6)

- Among **8** SPs who demand NFVO, there are **7** SPs also have requirements to deploy ONAP, **1** is uncertain;
- Among **7** SPs who expects to have both NFVO and ONAP, only **1** expects there would be not direct interaction between NFVO and ONAP, and all of the rest **6** SPs think in the short term, NFVO can interoperate with ONAP in a plug-in fashion, and eventually merged into ONAP in the long run.
- Among 6 SPs who expects short-term plug-in NFVO with ONAP, **5** want NFVO to interact with SDC/AAI/DCAE.

Part 2C: Design Time Alignment

Q7 : Do you expect SDC to support Network Service design for ESTI NFV based solution?

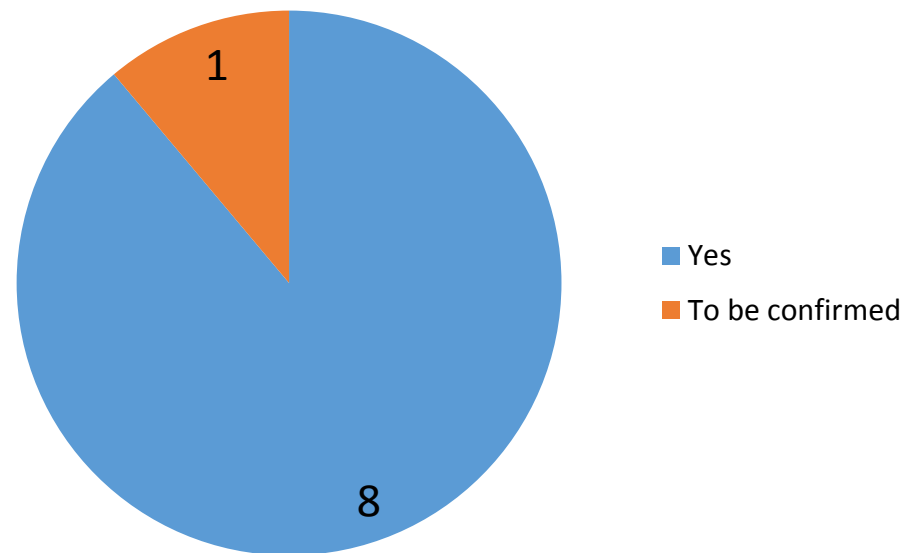

8 operators with NFVO deployment requirements answered YES.

Learnings from ETSI NFV Alignment

- All the SP expect ETSI NFV MANO adoption (8 NFVO + 1 VNFM).
- ONAP adoption could be accelerated in the short term if it provides ETSI NFV compliant MANO modules (NFVO, VNFM or both), which interact directly with OSS/BSS.
- ONAP adoption could be ensured in the long run if it provides interoperability with external NFVO/VNFM.
- SDC adoption could be accelerated if it provides support for Network Service Design, Packaging and Distribution.

Identified Requirement Summary

- ONAP is a platform which should provide flexibility for SPs to allow them choose its own incremental deployment approach
- ONAP should provide ETSI NFV SOL compliant NFVO and VNFM functionality; ONAP should be able to interact with external NFVO with SOL005, and external VNFM with SOL003
- ONAP NFVO and VNFM should be able to interacts externally with OSS/BSS with SOL compliant interface (SOL005), and interacts internally with SDC/AAI/DCAE
- SDC should support ETSI NFV compliant VNF Onboarding and NS design and distribution.



ONAP

OPEN NETWORK AUTOMATION PLATFORM

Thanks