



# Architecture Proposal for Deployment Flexibility

China mobile : Yan Yang

# Three Scenarios from SPs

- Core Network Virtualization Scenario

According to the survey results of service providers, most SPs' core network virtualization scenarios require ETSI NFV MANO compliant solution .

SPs who already have MANO products want to integrate with ONAP in a standardized way.

SPs without MANO products hope to incubate their MANO products based on ONAP.

- IT VNF Deployment Scenario

Different SPs need ONAP to support different deployment solution based on the specific t VNF type and requirements.

For example, vFW/vDNS can be deployed using Heat. If the VNFs are defined by the standard VNFD, ONAP is required to support standardized VNFD deployment.

- 5G/VoLTE Complex End-to-End Orchestration Scenario

In the face of complex end-to-end orchestration scenarios, such as 5G or VoLTE, ONAP is required to support ETSI NFV compliant NFVO and VNFM, and also support cross-domain end-to-end service orchestration.

# Proposed Architecture

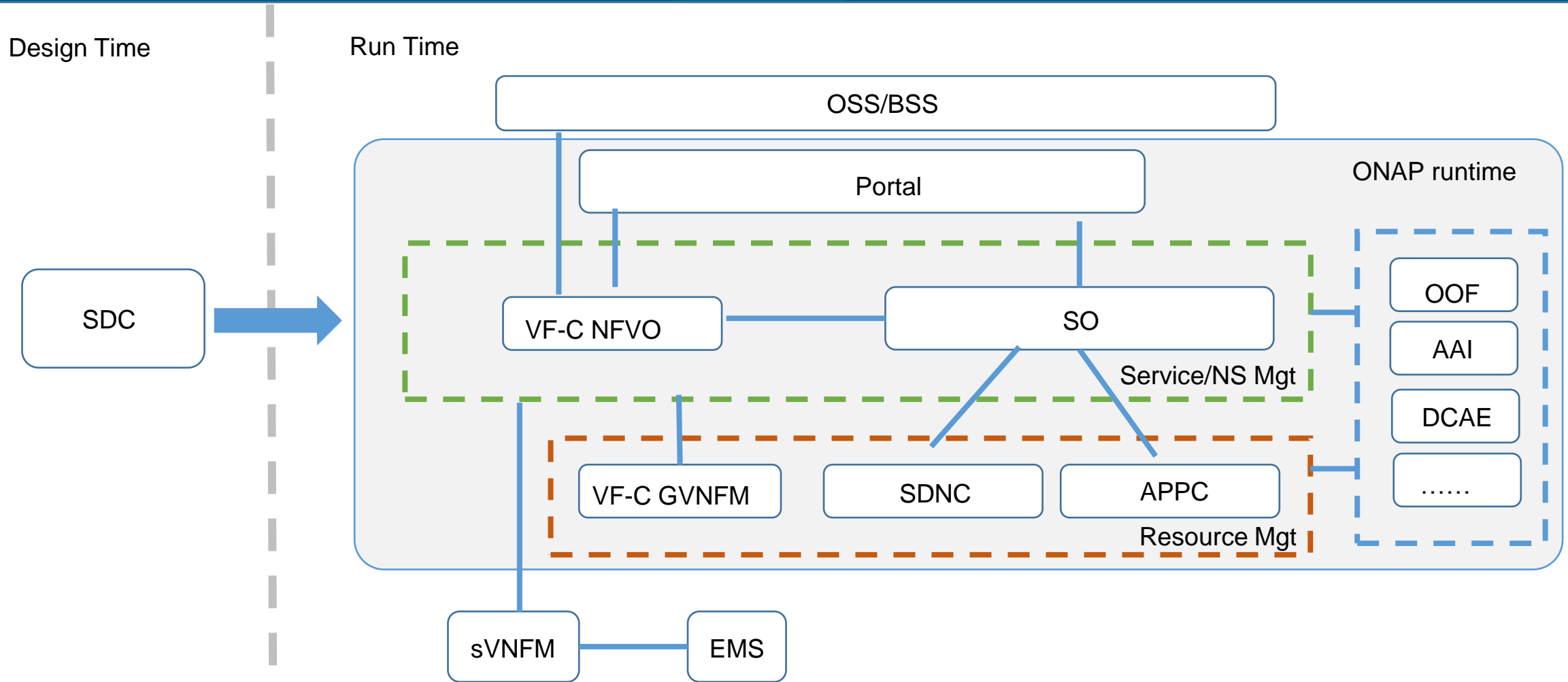

- Provide flexible architecture to allow SPs to enable different deployment approaches

# Deployment Scenario 1 – vEPC/vIMS

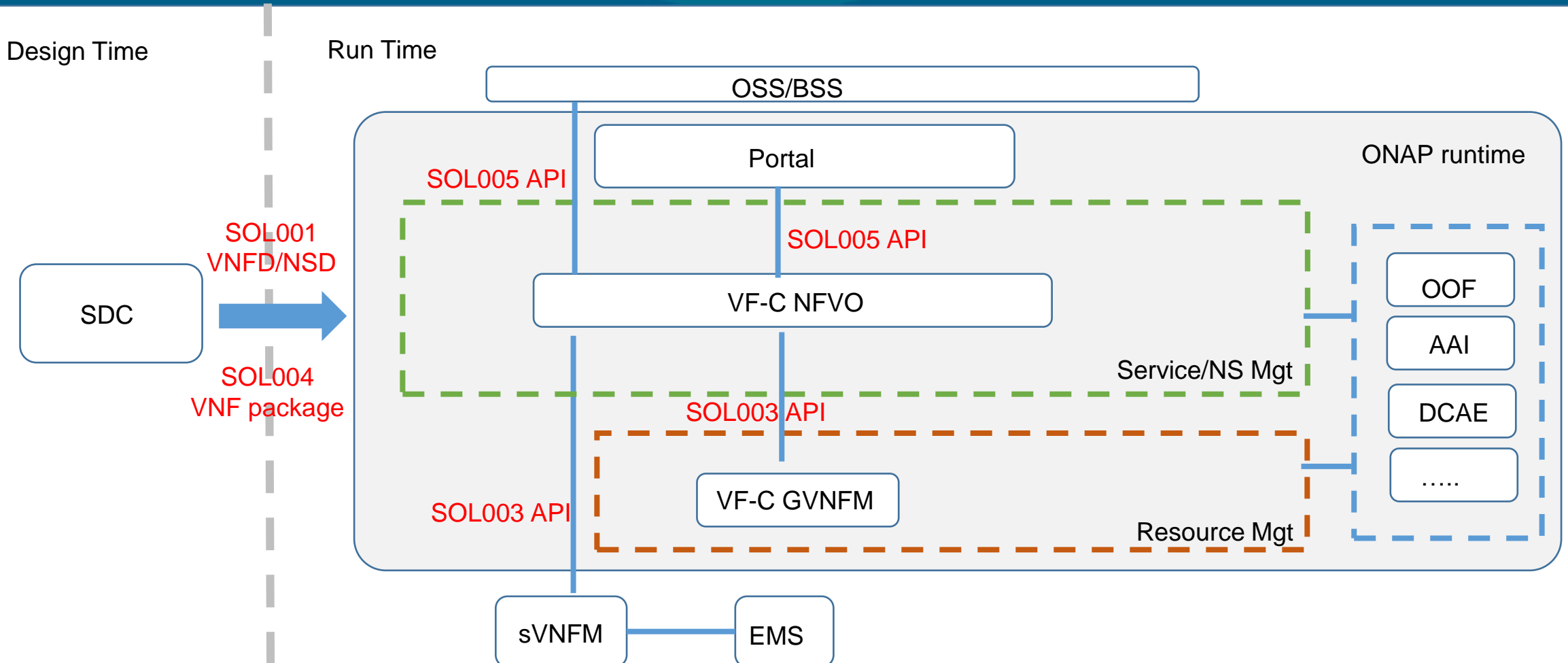

ONAP is required to support standard ETSI NFV MANO architecture, and supports the integration of existing MANO products with standardized models and interfaces. It also facilitates operators to incubate self-developed MANO products. The specific requirements for ONAP in this scenario:

- SDC supports the design and output of standard SOL001 VNFD/NSD
- NFVO northbound exposure SOL005 interfaces to OSS/BSS
- NFVO interacts sVNFM or GVNFM via SOL003

# Deployment Scenario 2 – CCVPN Case A

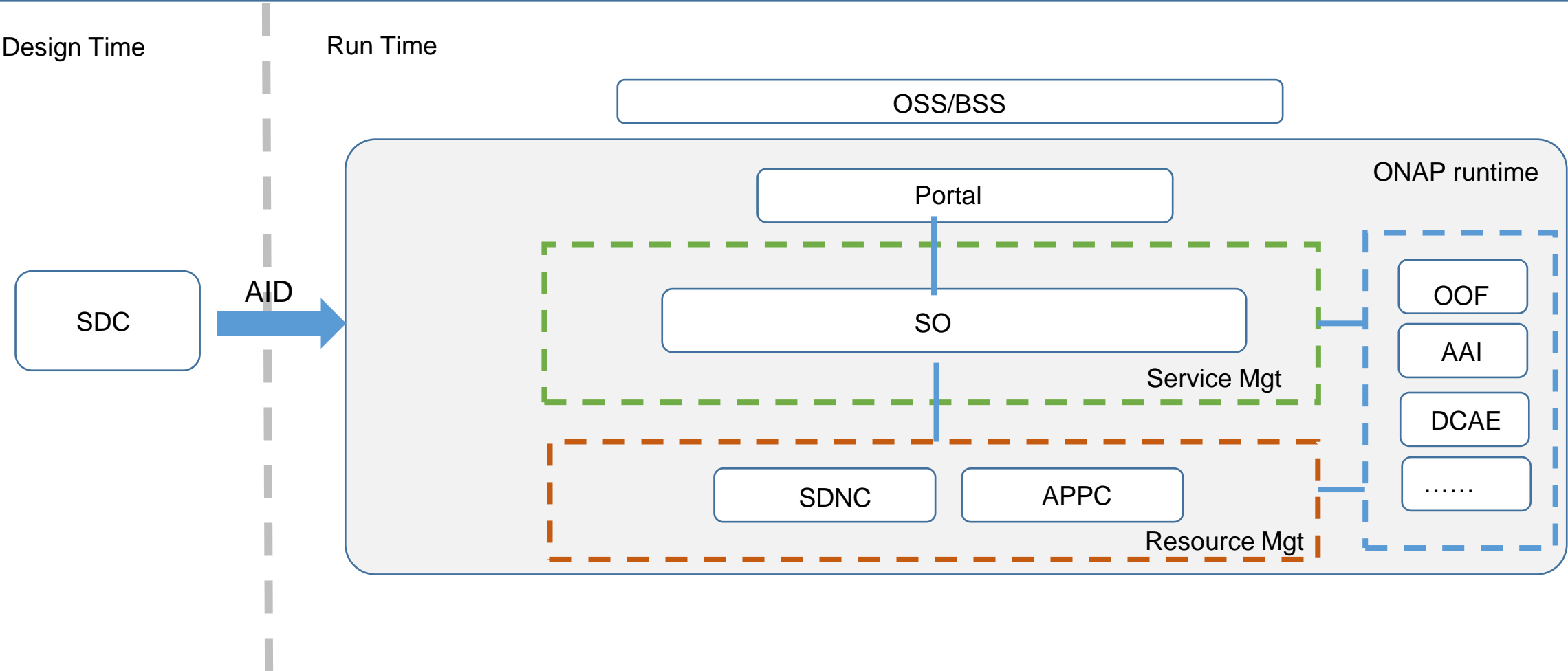

Take the vCPE deployment in CCVPN as an example. Currently, there are two types of vCPEs provided by vendors: Heat-based vCPE and standard VNFD-based vCPE. In ONAP solution, the Heat-based vCPE can be deployed through SO+SDNC+APPC which is also a way that ONAP currently supports.

# Deployment Scenario 3 – CCVPN Case B

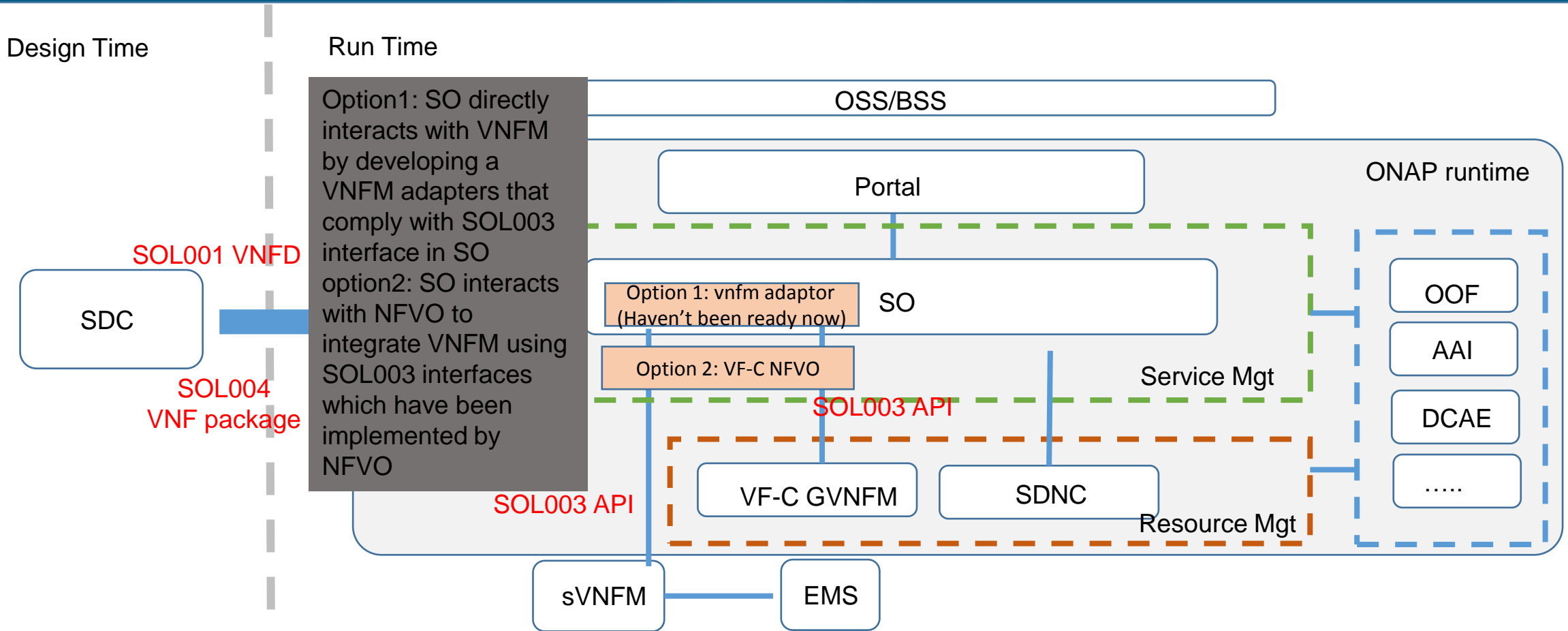

For vCPE deployment based on standard VNF/D, ONAP needs to support the standard VNF/D and cross-domain orchestration and doesn't need to support standard NS. The specific requirements for ONAP in this scenario:

- SDC supports the design and output of the standard SOL001 VNF/D
- SO interacts SDNC for cross-domain orchestration
- ONAP interacts sVNFM or GVNFM with standard SOL003 interface. Two implementation options as shown in slide,

# Deployment Scenario 4 – 5G

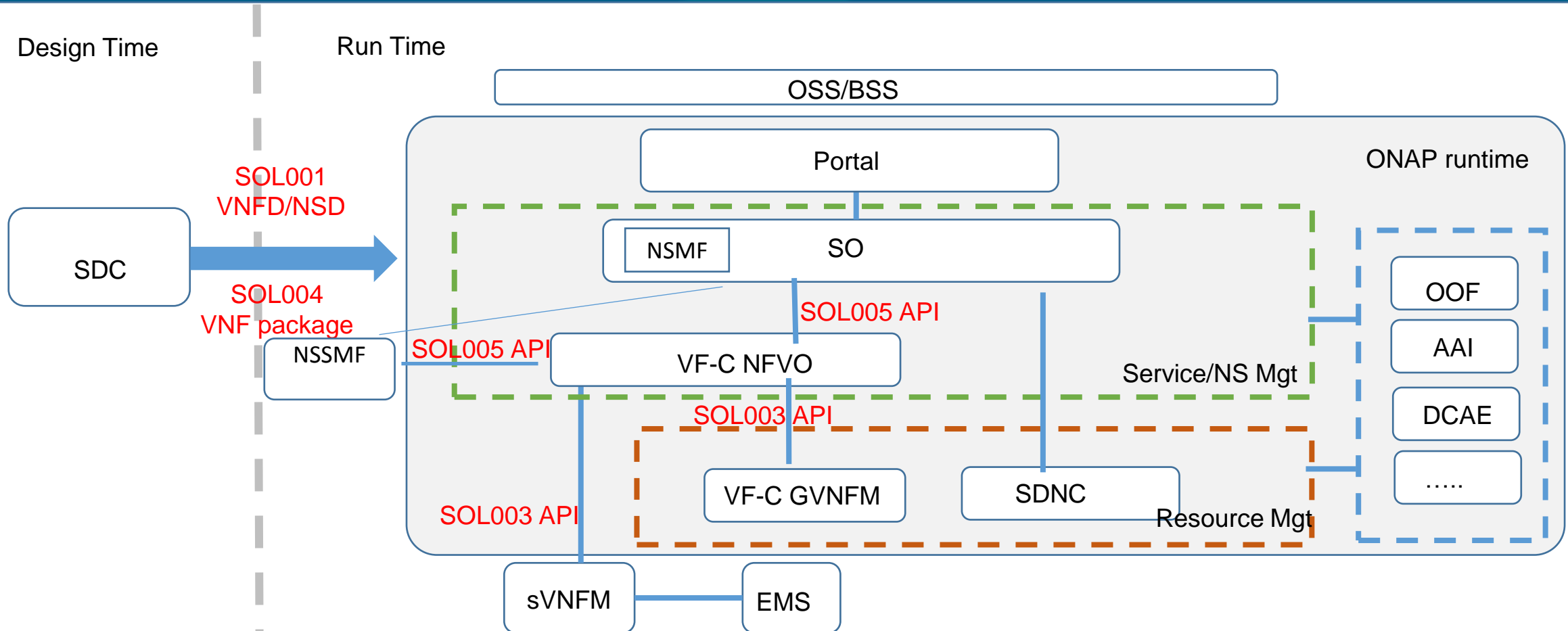

For 5G scenario, ONAP needs to support the standard ETSI MANO architecture and cross-domain end-to-end orchestration. The specific requirements for ONAP in this scenario :

- SDC supports the design and output of the standard SOL001 VNF/NSD
- SO implements end-to-end slice management and NSSMF interacts with VF-C to implement subnet-slice management via SOL005
- SO interacts SDNC for cross-domain orchestration
- VF-C interacts sVNFM or GVNFM via SOL003

# Requirements Summary

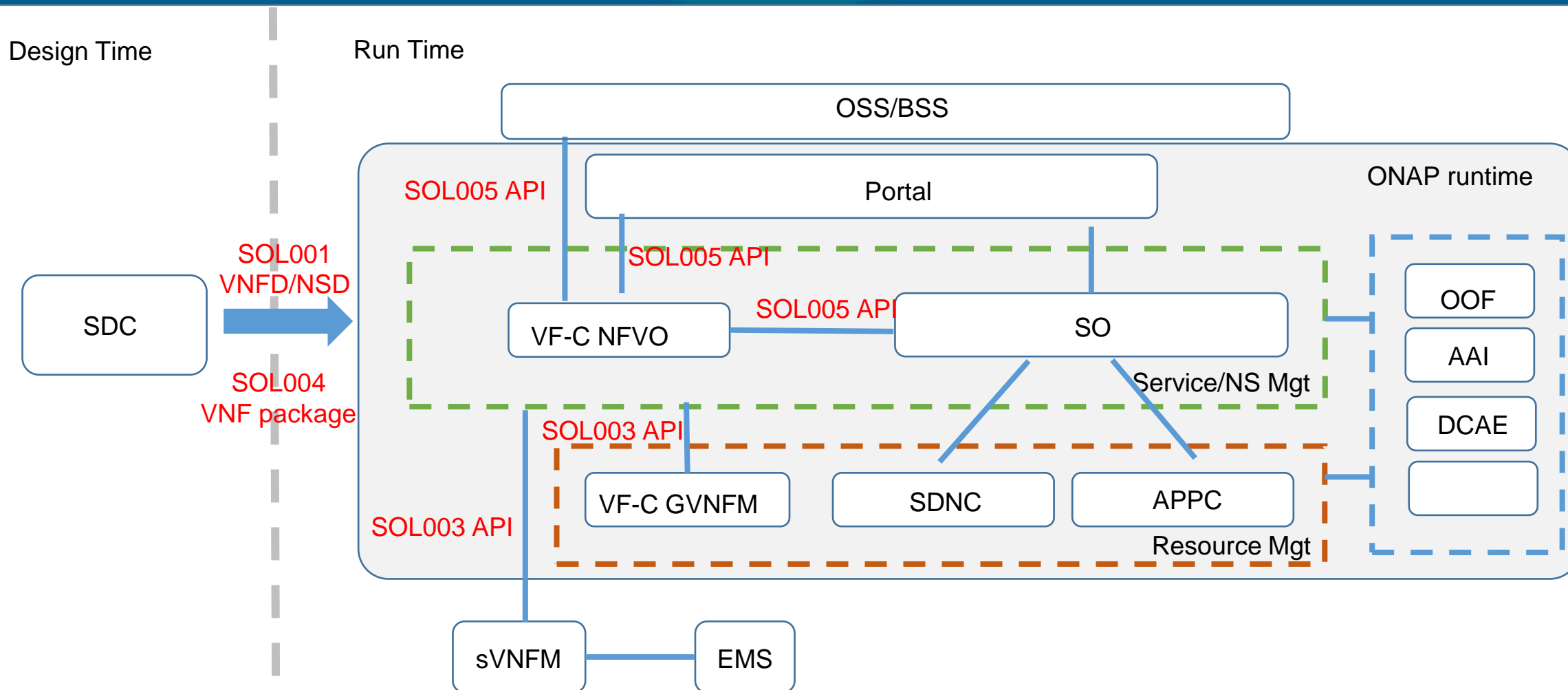

- SDC supports the design and output of SOL001 VNFD/NSD
- NFVO directly exposes SOL005 interface to OSS/BSS
- NFVO or SO is connected to SVNFM or GVNFM through SOL003 interface.



Welcome to join the offline discussion

Contact Information: yangyanyj@chinamobile.com, chaker.al.hakim@huawei.com

Time: Tuesday afternoon 1:00 pm – 2:30 pm

Zoom: <https://zoom.us/j/9117271979>

Location : TBD

# Thank you

# Deployment Scenario 4 – 5G

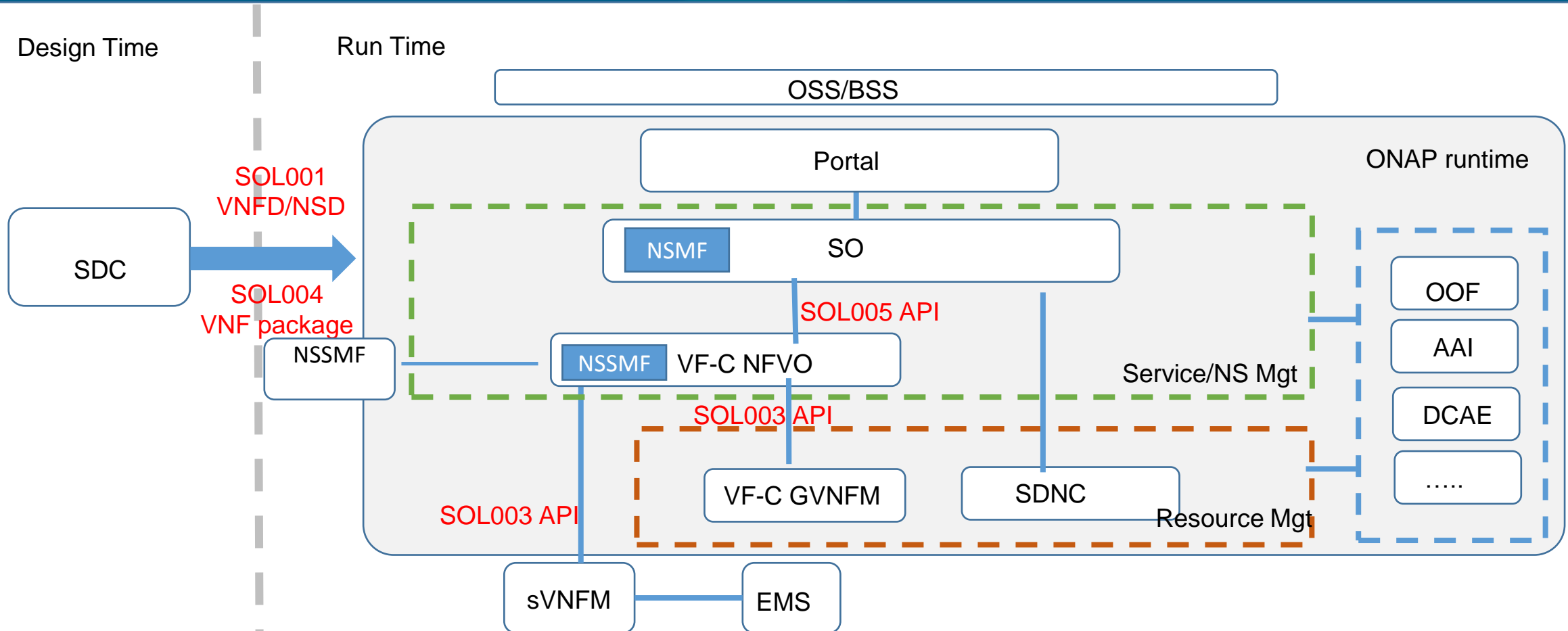

For 5G scenario, ONAP needs to support the standard ETSI MANO architecture and cross-domain end-to-end orchestration. The specific requirements for ONAP in this scenario :

- SDC supports the design and output of the standard SOL001 VNFD/NSD
- SO interacts with VF-C to implement end-to-end slice management through SOL005, where VFC is used as subnet-slice manager
- SO interacts SDNC for cross-domain orchestration
- VF-C interacts sVNFM or GVNFM via SOL003