



5G Provisioning management service to NRM

ONAP DDF, Jun 2019
Yaoguang Wang, Huawei

Outline

- Configuration Management in 3GPP SA5
 - Integration Reference Point
 - Management Services (MnS)
- Status of ONAP 5G UC about Configuration
- Proposal and plan

Reference List

ID	Reference
1	TS 32.602 Telecommunication management; Configuration Management (CM); Basic CM Integration Reference Point (IRP); Information Service (IS)
2	TS 32.662 Telecommunication management; Configuration Management (CM); Kernel CM Information Service (IS)
3	TS 32.658 Telecommunication management; Evolved Universal Terrestrial Radio Access Network (E-UTRAN) Network Resource Model (NRM) Integration Reference Point (IRP); Information Service (IS)
4	TS 28.530 Management and orchestration; Concepts, use cases and requirements
5	TS 28.531 Management and orchestration; Provisioning
6	TS 28.532 Management and orchestration; Generic management services
7	TS 28.533 Management and orchestration; Architecture framework
8	TS 28.540 Management and orchestration; 5G Network Resource Model (NRM); Stage 1 TS 28.541 Management and orchestration; 5G Network Resource Model (NRM); Stage 2 and stage 3
9	TR 28.890 Management and orchestration; Study on integration of Open Network Automation Platform (ONAP) and 3GPP management for 5G networks

Configuration Management in 3GPP SA5: Before R15

- Configuration Management (CM)^[1], in general, provides the operator with the ability to assure correct and effective operation of the 3G network as it evolves.
- CM actions have the objective to control and monitor the actual configuration on the Network Elements (NEs) and Network Resources (NRs), and they may be initiated by the operator or by functions in the Operations Systems (OSs) or NEs.

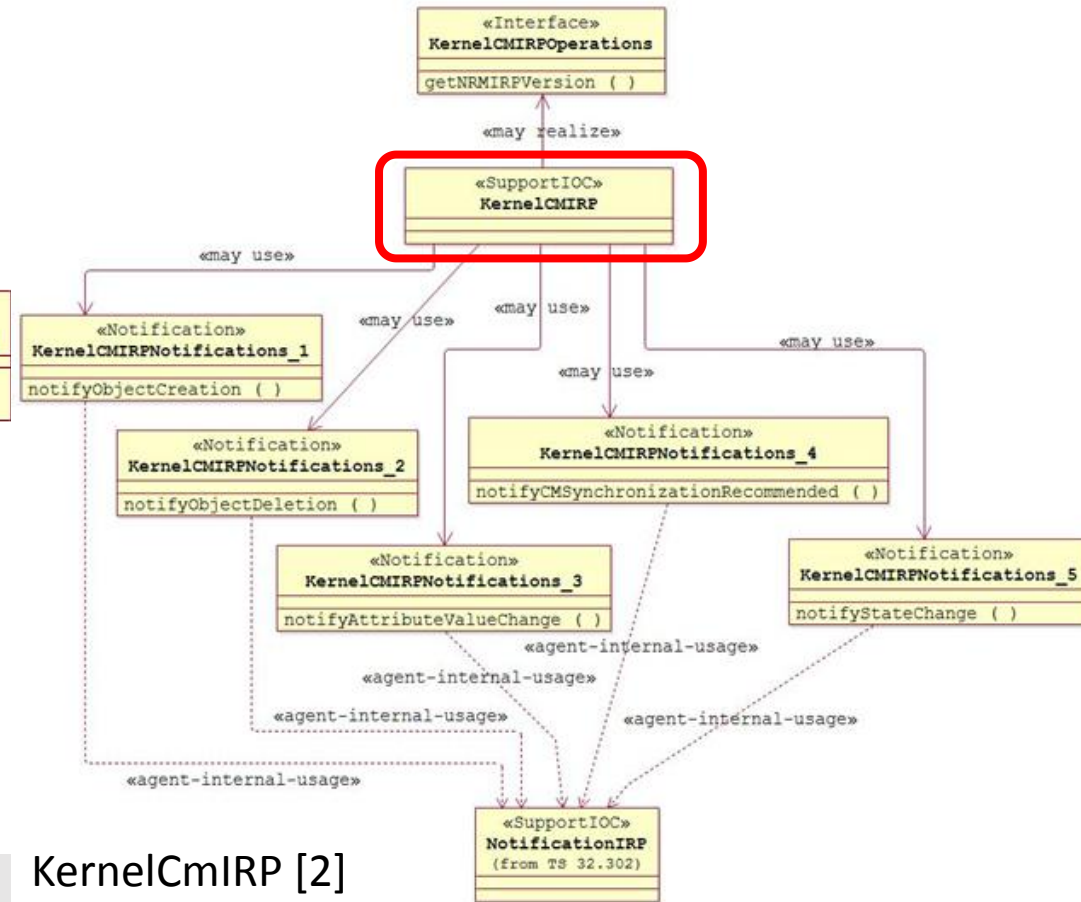
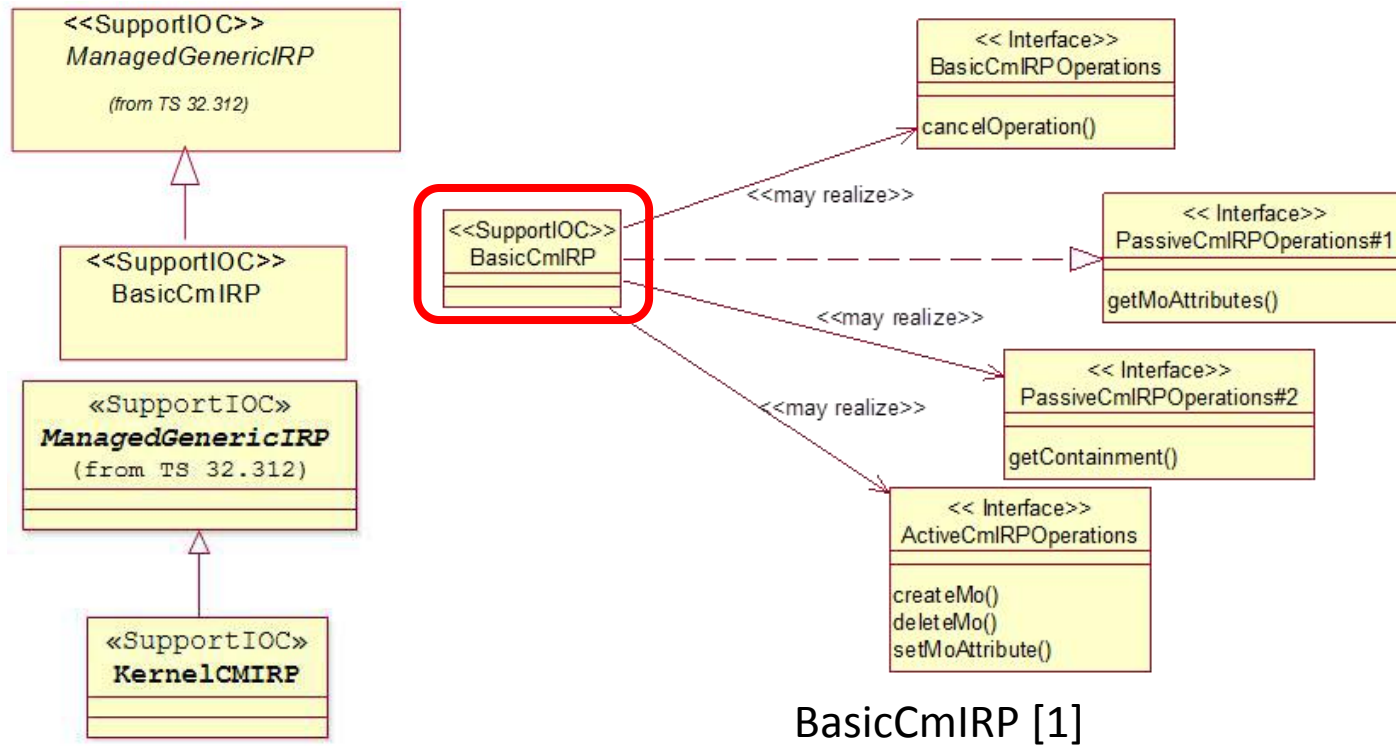

Configuration Management in 3GPP SA5: R15 & R16

- In TS 28.530[4], one of the principles that the **5G network management framework** is built upon is to support **service-based management**.

Requirements for NF provisioning service (28.531 [5])

REQ-PRO_NF-FUN-1	The NF provisioning service producer shall have the capability allowing its authorized consumer to request creation of an instance of 3GPP NF.
REQ-PRO_NF-FUN-2	The NF provisioning service producer shall have the capability to fulfill the consumer's request to create an instance of 3GPP NF .
REQ-PRO_NF-FUN-3	The NF provisioning service producer shall have the capability to provide the VNF and VNFC related information of the NF instance to its authorized consumer.
REQ-PRO_NF-FUN-4	The NF provisioning service producer shall have the capability allowing its authorized consumer to request configuration of a 3GPP NF instance.
REQ-PRO_NF-FUN-5	The NF provisioning service producer shall have the capability to request updating the VNF(s) that are realizing the virtualized part of a 3GPP NF.
REQ-PRO_NF-FUN-6	The NF provisioning service producer shall have the capability to fulfill the consumer's request to configure a 3GPP NF instance .
REQ-PRO_NF-FUN-7	The NF provisioning service producer shall have the capability to request NF management service producers working in the concerned NF instance to create and maintain the MOI(s) for it .

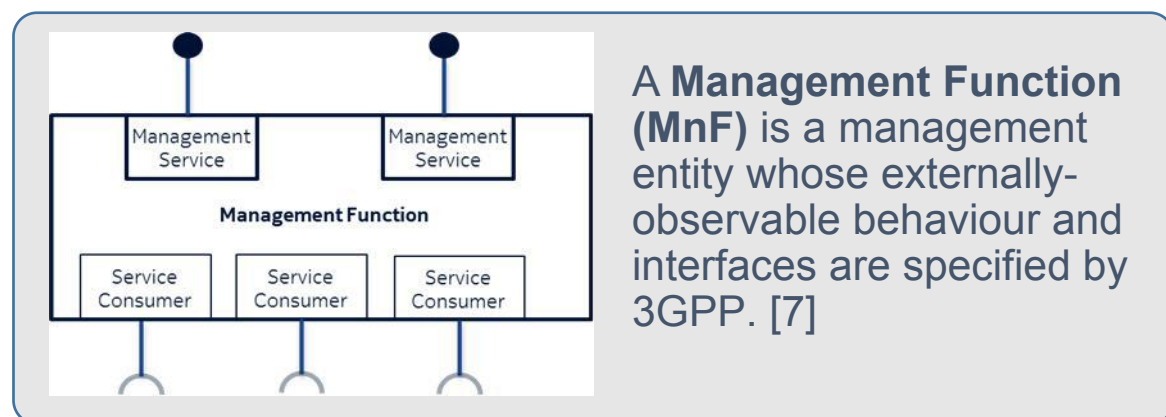
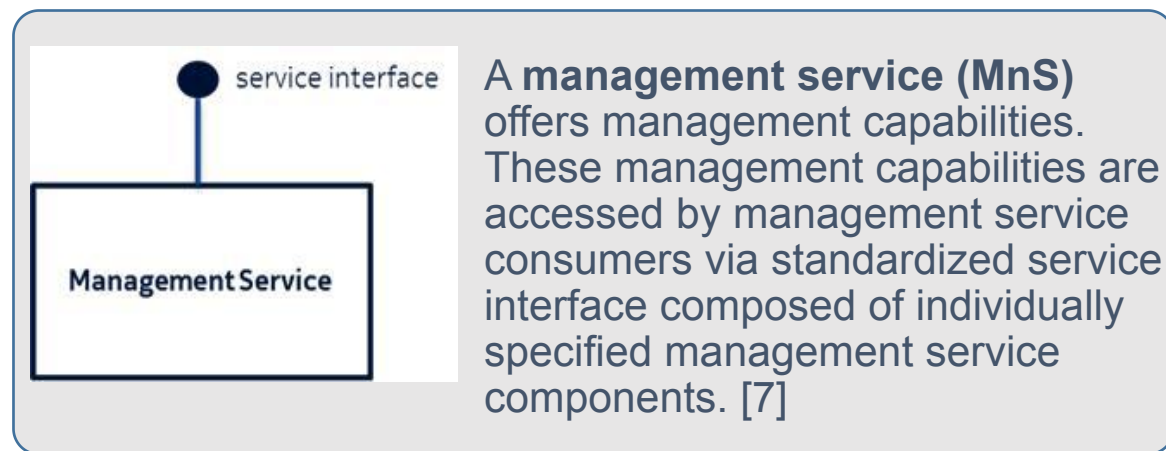

MnS(s) in 3GPP

- **Generic provisioning management service**, e.g. createMOI operation, getMOIAttributes operation, etc.
- Generic fault supervision MnS, Generic performance assurance MnS
- Performance assurance specific MnSs:
 - Measurement job control service for NF, Performance data file reporting service for NF, etc.
- Fault Supervision management services:
 - FS Data Report for NF, FS Control for NF, etc.

IS operation	HTTP Method	Resource URI	Qualifier
createMOI	PUT	/className/{id}	M
getMOIAttributes	GET	/className/{id}	M
modifyMOIAttributes	PATCH	/className/{id}	M
deleteMOI	DELETE	/className/{id}	M
subscribe	POST	/subscriptions	M
unSubscribe	DELETE DELETE	/subscriptions /subscriptions/{subscriptionId}	M M

RESTful HTTP-based solution set of provisioning

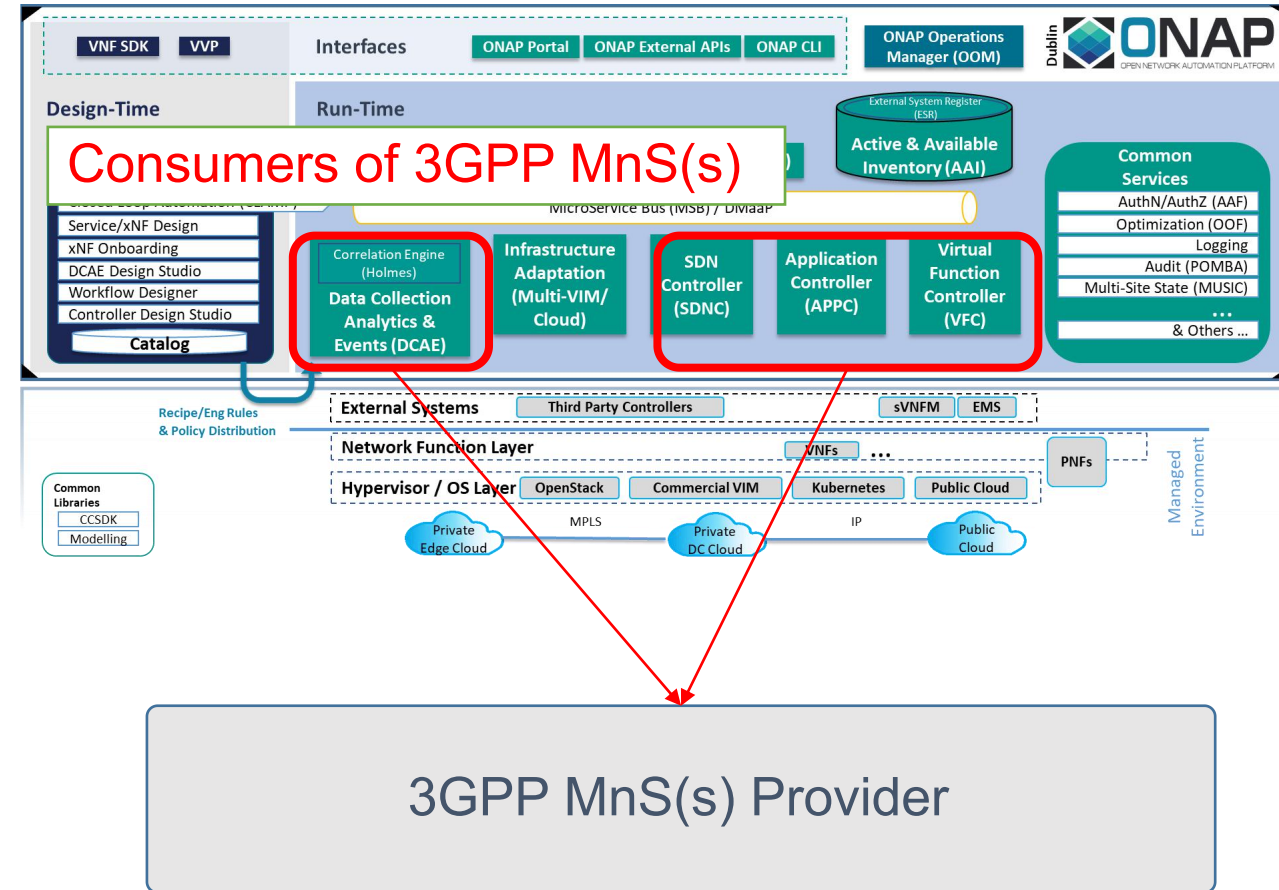

Ref: TR 28.890 [9]

NRM: Network Resource Model

Input Parameters of Operation "createMOI":

IS operation parameter name	SS parameter location	SS parameter name	SS parameter type	SQ
managedObjectClass	path	/{className}/	className: string	M
managedObjectInstance		{id}	id: string	
referenceObjectInstance	n/a	n/a	n/a	n/a
attributeListIn	request body	data	resourceCreation-RequestType	M

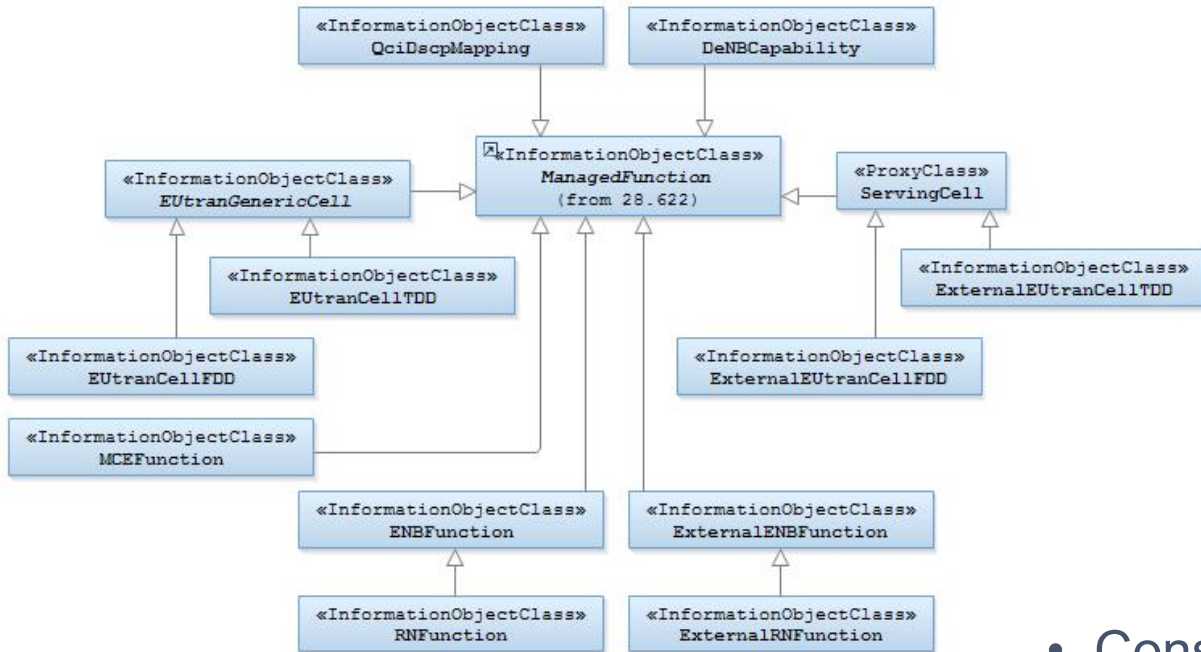

E-UTRAN NRM Inheritance Hierarchy [3]

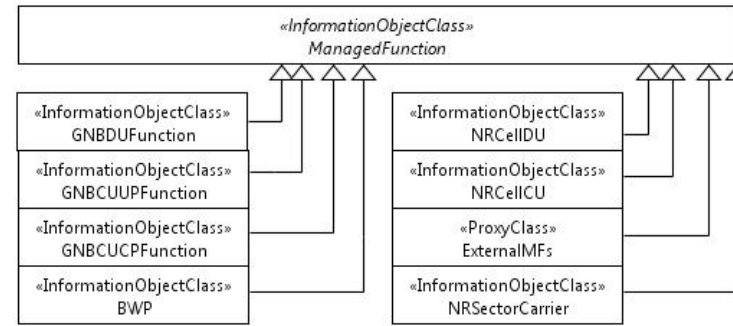

Inheritance Hierarchy for NR NRM[8]

Inheritance Hierarchy for 5GC NRM[8]

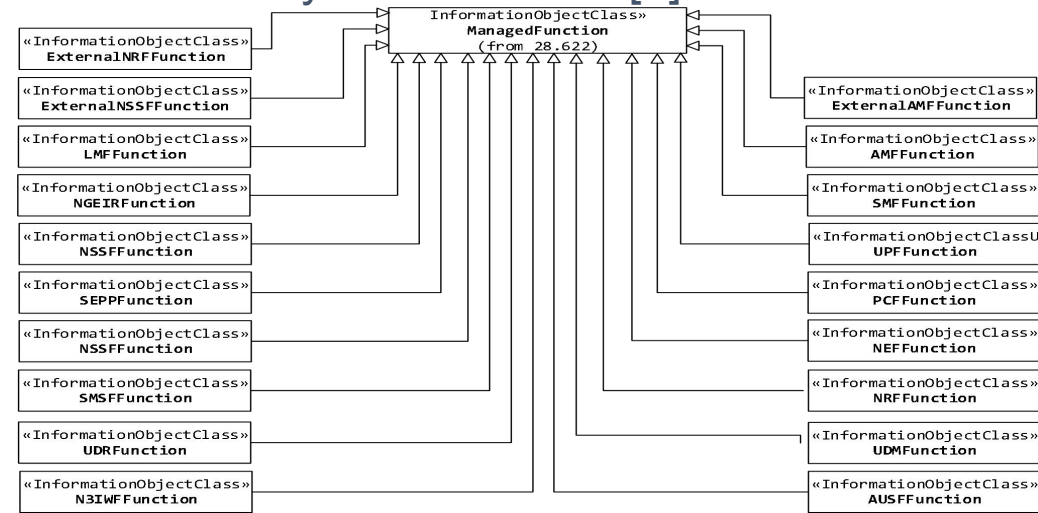

- Considering so many IOCs, is it possible to do the NRM configuration using model-driven approach?

Status of ONAP 5G UC about Configuration

ONAP 5G UC (to R4)
BULK PM
PNF PRE-ONBOARDING & ONBOARDING Use Case
CONFIGURATION WITH NETCONF
5G FM META DATA & 5G PM DICTIONARY
OOF & PCI
PNF Plug and Play
PNF S/W UPGRADE
NETWORK SLICING
HV Real-Time PM



- **PNF Registration:** allows to register within ONAP/AAI a PNF resource instance.
- **Service configuration:** Once a PNF resource is registered, the infrastructure service instantiation flows are able to continue the service instantiation, by calling controllers, which in turn configure the PNF instance (Step 36-37): Configuration Parameter (optional), OAM IP address (optional), Transport configuration (optional), Location (optional), Software Version (optional).

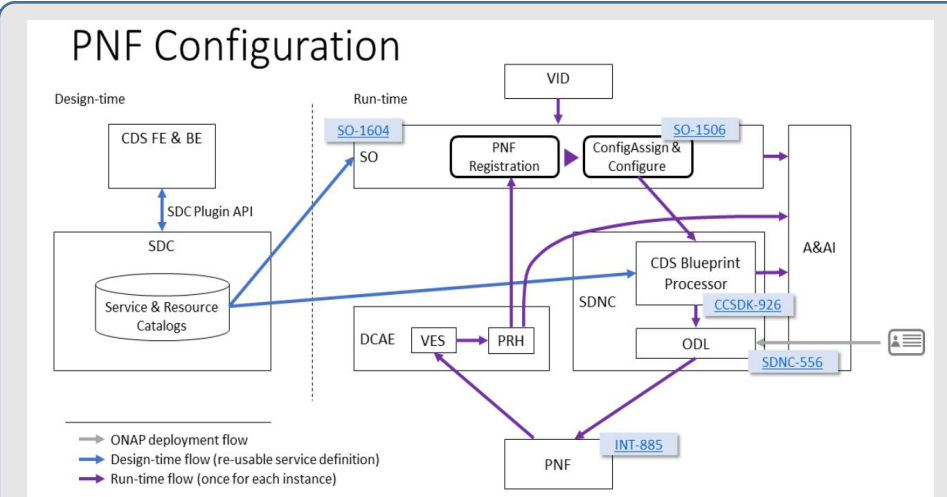
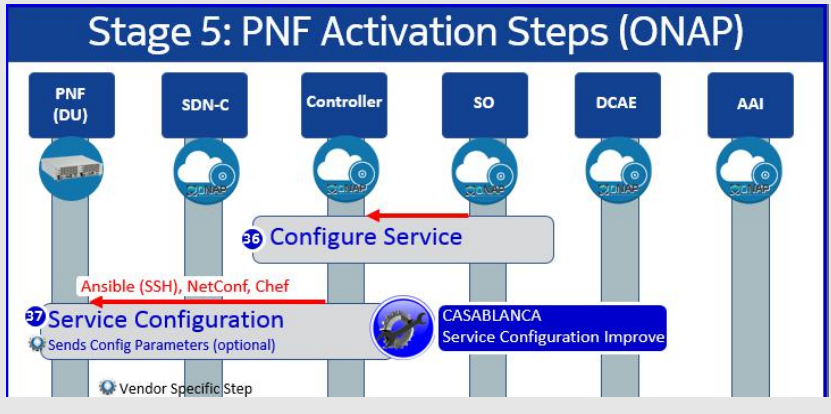

- Focus on in Dublin for configuration with NETCONF: **Post-instantiation** (triggered by SO), Including final configuration step (36/37) in the PNF PnP UC.

```
public class ConfigAssignPropertiesForPnf {
    @JsonProperty("service-instance-id")
    private String serviceInstanceId;

    @JsonProperty("pnf-id")
    private String pnfId;

    @JsonProperty("pnf-name")
    private String pnfName;

    @JsonProperty("service-model-uuid")
    private String serviceModelUuid;

    @JsonProperty("pnf-customization-uuid")
    private String pnfCustomizationUuid;

    @JsonIgnore
    private Map<String, Object> userParam = new HashMap<String, Object>();
}
```

Proposal: Integration of ONAP with 3GPP NRM configuraion

- Integration of ONAP with 3GPP management for 5G networks on NRM configuration management:
 - Support service-based management
 - Resolve the huge number of IOCs adaptively during the NRM configuration

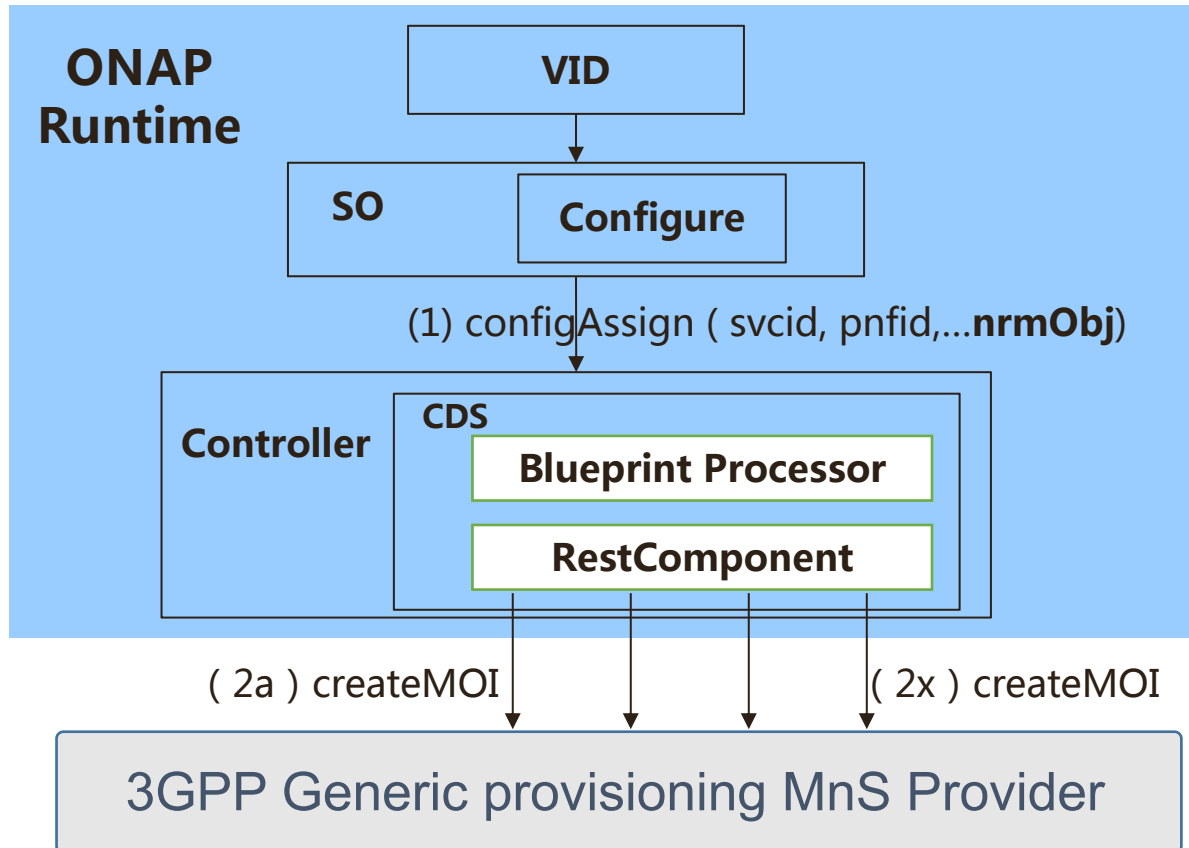

Step 1 (SO-Controller) in R4

```

{
  "actionIdentifiers": {
    "actionName": "config-assign",
    "blueprintName": "configuration_over_restconf",
    "blueprintVersion": "1.0.0",
    "mode": "sync"
  },
  "commonHeader": {
    "originatorId": "sdnc",
    "requestId": "123456-1000",
    "subRequestId": "sub-123456-1000"
  },
  "payload": {
    "config-assign-request": {
      "resolution-key": "RES-KEY 4",
      "config-assign-properties": {
        "service-instance-id": "siid_1234",
        "pnf-id": "netopeer2",
        "pnf-name": "10.149.89.217",
        "service-model-uuid": "service-model-uuid",
        "pnf-customization-uuid": "pnf-customization-uuid"
      }
    }
  }
}
    
```

R5/R6 :

config-modify
restful

nrmObj:

```

"EUtranGenericCell" : [
  { "cellLocalId" :1, "pci" :5},
  { "cellLocalId" :2, "pci" :6},
  {}],
"ExternalEUtranCell" : [
  { "cellLocalId" :1," " eNBId" :x},
  { "cellLocalId" :2," " eNBId" :y},
  ],
"EUtranRelation" : [{}]
    
```

Step 2a–2x: NRM configuration request to provisioning MnS provider (Ref [6])

IS operation	HTTP Method	Resource URI	Qualifier
createMOI	PUT	/{{className}}/{id}	M
getMOIAttributes	GET	/{{className}}/{id}	M
modifyMOIAttributes	PATCH	/{{className}}/{id}	M
deleteMOI	DELETE	/{{className}}/{id}	M

Some scenarios

```
nrmObj:
  "NRCellIDU" : [
    { "nCI" :1, "nRPCI" :5},
    { "nCI" :2, "nRPCI" :6},{}],
  "NRCellRelation" : [
    { "Id" :1," "nRTCI" :x},
    { "Id" :2," "nRTCI" :y}],
  "GNBDUFunction: [{}]
```

config-assign

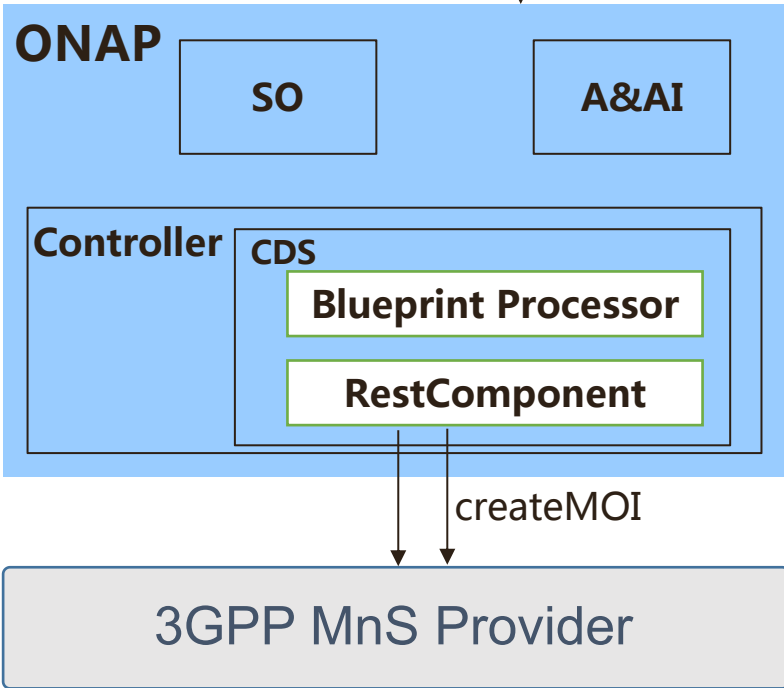

A. Configuration for NR NRM

```
nrmObj:
  "SMFFunction" : [
    { "pLMNIdList" :x, "nRTAClist" :y}],
  "AMFFunction" : [
    { "pLMNIdList" :x, "aMFIdentifier" :y}],
  UPFFunction:[
    { "pLMNIdList" :x, "nRTAClist" :y}]
```

config-assign

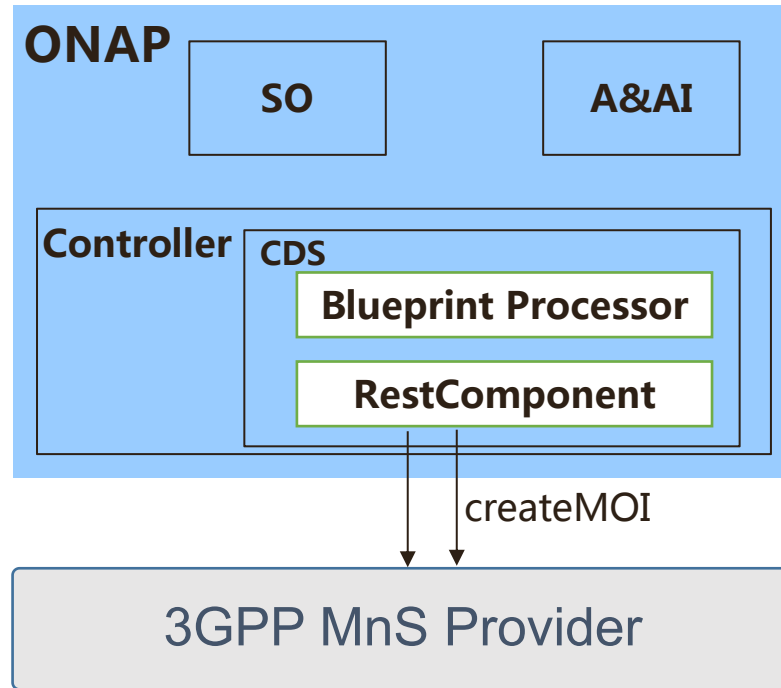

B. Configuration for 5GC NRM

```
nrmObj:
  "NRCellIDU" : [
    { "nCI" :1, "nRPCI" :8},
    { "nCI" :2, "nRPCI" :9}]
```

config-modify

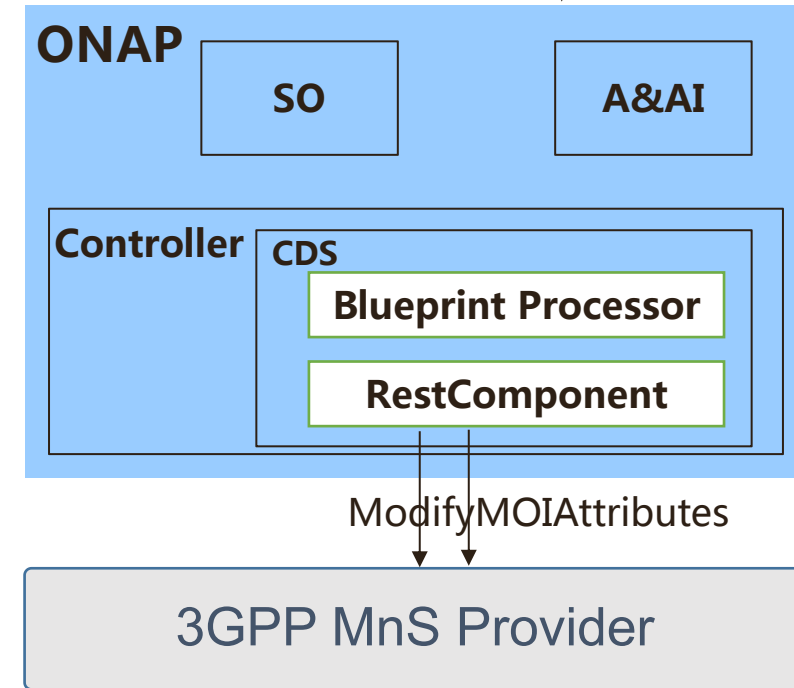

C. Modify a few MOIs for NR NRM

Project impacts

Project Name	Impacts	Target Release
CCSDK	<p>Middle Impacts:</p> <ul style="list-style-type: none">• Add a new restful component, which splits the payload from self-service API request in to primitive attributes and MO attributes, and sends requests to the provisioning MnS provider according to the number of IOCs.• Enhance corresponding message structures as needed.• Differentiate several actions wrt. operations, such as create, get, modify and delete.	R5/R6
SDC	<p>Minor Impacts:</p> <ul style="list-style-type: none">• Blueprint design and distribution	R6
SO	<p>Minor Impacts:</p> <ul style="list-style-type: none">• PNF related NRM configuration BPMNs.	R6

Conclusions

- 3GPP SA5 provides many information sets (such as information models, operations) and solution sets. ONAP could benefit from those achievements and support complete lifecycle management.
- From Beijing to Dublin, ONAP 5G use case did a great work on 5G PNF management, especially on configuration management. When PNF instances are registered and post-instantiated, they need to do correct NRM configurations for real mobile service.
- We propose to enhance the CDS-based controller for 5G NRM configuration management.



ONAP

OPEN NETWORK AUTOMATION PLATFORM

Thank You!