



LFN Developer & Testing Forum

ONAP: Network Management Community Coordination

Automation - 3GPP SA5

Closed Control-Loop Automation - ETSI ZSM, IRTF NMRG, ONAP

0) Introduction

[Magnus Buhrgard](#), ONAP Community Coordinator for Generic Network Management

1) Hot topics on automation in 3GPP SA5

[Thomas Tovingner](#), 3GPP SA5 Chair

[Zou Lan](#), 3GPP SA5 Vice-chair

2) Closed Control-Loop Automation - ETSI ZSM, IRTF, ONAP

[Pedro Henrique Gomes](#), ETSI ZSM

[Laurent Ciavaglia](#), IRTF NMRG

[Liam Fallon](#), ONAP











3) Q&A



Hot topics on automation in 3GPP SA5

Thomas Tovinger, SA5 Chair, ERICSSON
Zou Lan, SA5 Vice-Chair, HUAWEI

Contents

-  3GPP & SA5 introduction
-  Overview of 3GPP SA5 Rel-17 WIs/SIs
-  3GPP SA5 hot automation topics
 -  Autonomous Network
 -  Levels of Autonomous Network
 -  Intent driven management
 -  Control loops
 -  Management data analytics
 -  SON
 -  Network slicing
-  Summary

3GPP & SA5 Introduction

3GPP standards eco-system



Organizational Partners (OPs)



700+ companies

➤ The 3GPP **Organizational Partners (OP)** - 7 Standards Organizations - from China, Europe, India, Japan, Korea and the United States.

➤ Participation in 3GPP by companies and organizations becoming Members of one of these 7 OPs.

➤ Inputs on market requirements may come in to the Project via 3GPP **Market Representation Partners (MRP)**.

➤ There is a lot of additional **external liaison activity**...SDOs, Industry bodies, projects...

Market Representation Partners (MRPs)



5G Projects



Certification Bodies



Official Liaisons on specification work:

450 MHz Alliance, AISG, Bluetooth, Broadband Forum (BBF), CableLabs, International Special Committee on Radio Interference (CISPR), CTIA, Digital Video Broadcasting (DVB) Project, Ecma, International, Expert Group for Emergency Access (EGEA), Eurescom, COST 273, European Radiocommunications Committee (ERC), Fixed Mobile Convergence Alliance (FMCA), GCF, Global TD-LTE Initiative (GTD), GPS Industry Council, GSM Association, HomeRF Forum, IDB Forum, IEEE, Internet Engineering Task Force (IETF), IrDA, International Multimedia Telecommunications Consortium (IMTC), Internet Streaming Media Alliance, ISO-ITU expert group, ISO MPEG / JPEG, ITU-T SG2, JAIN tm (Javatm APIs for Integrated Networks), The Java Community Process (JCP), Liberty Alliance Project, Metro Ethernet Forum (MEF), NENA, NGMN (Next Generation Mobile Networks), oneM2M, OMA (Open Mobile Alliance), Open Networking Foundation (ONF), Open IPTV Forum, Object Management Group (OMG), PCS Type Certification Review Board (PTCRB), Portable Computer and Communications Association (PCCA), Presence and Availability Management (PAM) Forum, RSA Laboratories, SDR Forum, Sun Micro Systems Inc., Steerco, SyncML Initiative, Trusted Computing Group (TCG), TeleManagement Forum (TMF), TCCA, TIA /TR45, TIA/TR47, ITU, TV-anytime Forum, Voice eXtensible Mark-up Language (VXML) Forum, Wi-Fi Alliance, Wireless Broadband Alliance (WBA), WLAN Smart Card Consortium, Wireless World Research Forum (WWRF), World Wide Web Consortium (W3C)

[Source: extract from <https://www.3gpp.org/about-3gpp/15-bodies-with-which-3gpp-has>]

Specification Groups



3GPP Project Co-ordination Group (PCG)

- The TSGs prepare, approve and maintain the 3GPP Technical Specifications and Technical Reports.
- They are responsible for the detailed time frame and management of the work's progress;
 - Management of work items;
 - Technical Co-ordination;
 - Proposal and approval of work items within the agreed scope and terms of reference of the TSG
- The TSG Chairman is responsible for the overall management of the technical work within the TSG and its Working Groups.
- The WG Chairman is responsible for the overall management of the technical work within the WG and its sub-groups.

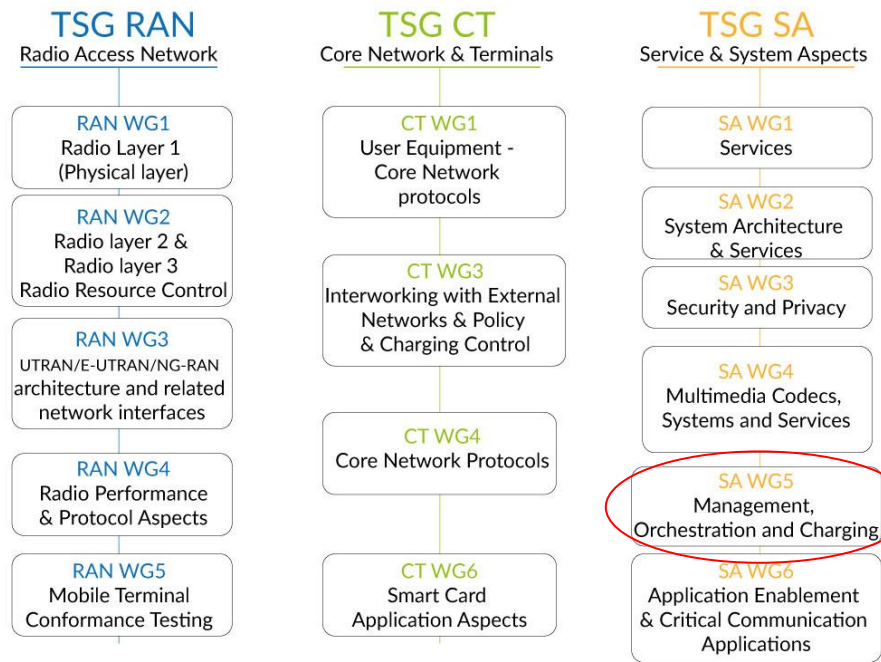

© 3GPP

3GPP 5G Timeline



Release timing



Phases for the normative 5G work:

- Normally planned as 18-month cycles. Pandemic => 2 years
- Phase 1 (Rel-15) addresses the more urgent subset for commercial deployments
- Phase 2 (Rel-16) Completes the 3GPP IMT 2020 submission (ITU-R) and addresses all identified use cases & requirements
- Release 17 and Release 18 are 5G Releases too...

3GPP SA5 Autonomous Network related topics

Autonomous network related topics in LTE and 5G



LTE

- 3GPP SA5 has standardized management of automation for LTE since Rel-8 (in 2008):
 - Self-Organizing Network (SON) including
 - SON concepts and requirements
 - Self-configuration
 - Automatic (cell) Neighbour Relation (ANR)
 - Self-optimization
 - Self-healing

5G

- Autonomous network levels
- Intent driven management service for mobile networks
- Enhanced Closed loop SLS Assurance
- Enhancements of Management Data Analytics Service
- Enhancements of Self-Organizing Networks (SON) for 5G networks
- Network policy management for 5G mobile networks
- Generic Plug and connect
- Enhancement of Handover Optimization
- Enhancements on EE for 5G networks
- Discovery of management services in 5G

Overview of 3GPP SA5 OAM Rel-17 WIs/SIs



Rel-17: 28 ongoing WIs/SIs, 3 finished SI, 1 WI and 1 SI for SA approval

- 20 ongoing WIs, 1 WI wait for SA approval
- 8 ongoing SIs, 3 finished SI, 1 SI wait for SA approval

Rel-17 OAM&P Studies			
1	Study on new aspects of EE for 5G networks	FS_EE5G	870021
2	Study on YANG PUSH	FS_YANG	890017
3	Study on continuous integration continuous delivery support for 3GPP NFs	FS_CICDNS	910028
4	Study on enhancements of edge computing management	FS_eEDGE_Mgt	870029
5	Study on network slice management enhancements	FS_NSMEN	860022
6	Study on enhancement of service based management architecture	FS_eSBMA	910031
7	Study on access control for management service	FS_MNSAC	890016
8	Study on management aspects of network slice management capability exposure	FS_NSCE	910026
new	Study on Management Aspects of 5G Network Sharing	FS_MANS	Wait for SA approval
9	Study on autonomous network levels (finished)	FS_ANL	850032
10	Study on management and orchestration aspects with integrated satellite components in a 5G network	FS_5GSAI_MO	830025
11	Study on enhancement of Management Data Analytics Service	FS_eMDAS	850028

Rel-17 Operations, Administration, Maintenance and Provisioning (OAM&P)			
1	Additional NRM features	adNRM	870026
2	Enhancements of 5G performance measurements and KPIs	ePM_KPI_5G	880025
3	Management of MDT enhancement in 5G	e_5GMDT	870025
4	Enhancement of QoE Measurement Collection	eQoE	870027
5	Management data collection control and discovery	MADCOL	880028
6	Management Aspects of 5G Network Sharing	MANS	900021
7	File Management	FIMA	910030
8	Autonomous network levels	ANL	880027
9	Intent driven management service for mobile networks	IDMS_MN	810027
10	Network policy management for 5G mobile networks	NPM	860024
11	Enhanced Closed loop SLS Assurance	eCOSLA	870030
12	Enhancements of Management Data Analytics Service	eMDAS	850028
13	Enhancements of Self-Organizing Networks (SON) for 5G networks	eSON_5G	870028
14	Generic Plug and connect	PACMAN	910029
15	Enhancement of Handover Optimization	E_HOO	880029
16	Enhancements on EE for 5G networks	EE5GPLUS	870022
17	Discovery of management services in 5G	5GDMS	820035
18	Management of non-public networks	OAM_NPN	870023
19	Enhancement on Management Aspects of 5G Service-Level Agreement	EMA5SLA	870024
20	Management of the enhanced tenant concept	eMEMTANE	880026
new	Edge Computing Management	ECM	Wait for SA approval

Levels of Autonomous Network - Introduction



- 👉 In 3GPP Release 16, SA5 has completed a study on levels of autonomous network, whose results are captured in Technical Report (TR) 28.810:
 - 📶 3GPP TR 28.810: “Study on concept, requirements and solutions for levels of autonomous network”

- 👉 In 3GPP Release 17, SA5 has started a normative work item using the above TR as input, developing the following draft Technical Specification (TS):
 - 📶 3GPP draft TS 28.100: “Management and orchestration; Levels of autonomous network”
 - 📶 Status summary of this work item:
 - 📶 Aiming to define the different levels of autonomy of a network, from fully manual to fully automatic
 - 📶 Currently (version 0.5.0): described a possibility and examples of classifying autonomous level properties of (individual) functions in a 3GPP system (e.g. Fault management).

Definition and concept – draft TS 28.100



Definition:

- 📶 **Autonomous Network:** telecommunication system (including management system and network) with autonomy capabilities which is able to be governed by itself with minimal to no human intervention.
- 📶 **Autonomous Network Level:** describes the level of autonomy capabilities in the autonomous network.



Three Dimensions for evaluating autonomous network levels

Workflow

- 📶 Intent handling
- 📶 Awareness
- 📶 Analysis
- 📶 Decision
- 📶 Execution

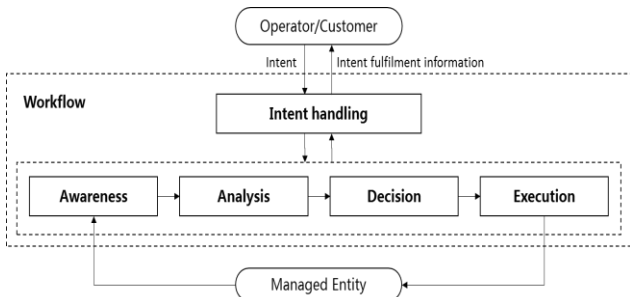

Figure 4.3.4-1: Categorization of the tasks in the workflow for evaluating autonomous network levels

Management scope

- 📶 Autonomy in NE/NF layer
- 📶 Autonomy in domain network layer
- 📶 Autonomy in cross domain network layer
- 📶 Autonomy in communication service layer

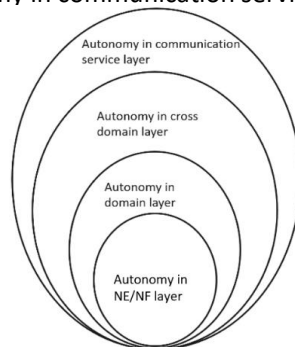

Figure 4.3.3-1: Autonomy for different management scope

Scenarios

- 📶 Network and service planning
- 📶 Network and service deployment
- 📶 Network and service maintenance
- 📶 Network and service optimization

Note: The content of this slide is under discussion in the draft TS 28.100.

Framework approach for evaluating autonomous network levels (draft TS 28.100)

Network autonomy level		Task categories				
		Execution	Awareness	Analysis	Decision	Intent handling
L0	Manual operating network	Human	Human	Human	Human	Human
L1	Assisted operating network	Human & Telecom system	Human & Telecom system	Human	Human	Human
L2	Preliminary autonomous network	Telecom system	Human & Telecom system	Human & Telecom system	Human	Human
L3	Intermediate autonomous network	Telecom system	Telecom system	Human & Telecom system	Human & Telecom system	Human
L4	Advanced autonomous network	Telecom system	Telecom system	Telecom system	Telecom system	Human & Telecom system
L5	Full autonomous network	Telecom system	Telecom system	Telecom system	Telecom system	Telecom system

Note 1: Human reviewed decisions have the highest authority in each level if there is any conflict between human reviewed decision and telecom system generated decision.

Note 2: The order of above five task categories does not reflect the workflow sequence.

Note: The content of this slide is under discussion in the draft TS 28.100. For detailed definitions, use cases and examples, see draft TS 28.100.

Intent driven management for mobile networks - Introduction



- 📶 **Objective: To simplify the management interfaces by using expressions of intent**
- 📶 Release 17 study: Concept, scenarios and potential solutions
 - 📶 3GPP TR 28.812: “Telecommunication management; Study on scenarios for Intent driven management services for mobile networks”
- 📶 Release 17 normative work item – in progress:
 - 📶 3GPP draft TS 28.312 (v050): “ Management and orchestration; Intent driven management services for mobile networks”

Definition and concept - Intent driven management (draft TS 28.312)

Definition

Intent: the expectations including requirements, goals and constraints given to a 3GPP system, without specifying how to achieve them.

Intent driven MnS

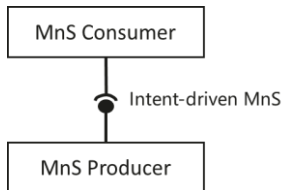

Intent driven closed-loop

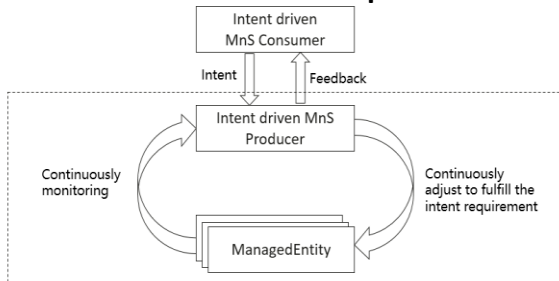

Relation between rule, policy and intent

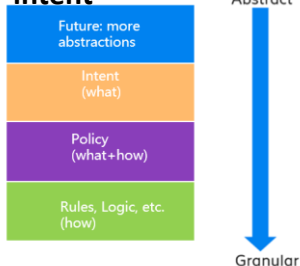

Intent categorizes based on user types

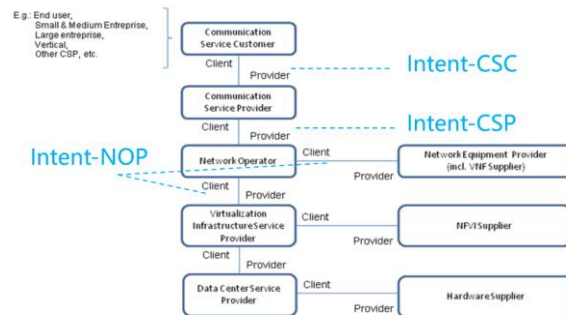

Intent from Communication Service Customer (Intent-CSC): For example, Intent-CSC can be 'Enable a V2X communication service for a group of vehicles in certain time'.

Intent from Communication Service Provider (Intent-CSP): For example, Intent-CSP can be 'Provide a network service supporting V2X communications for highway-417 to support 500 vehicles simultaneously'.

Intent from Network Operator (Intent-NOP): For example, Intent-NOP can be 'Provide a radio network service to satisfy the specified coverage requirements and UE throughput requirement in certain area'.

Note: The content of this slide is under discussion in the draft TS 28.312.

Closed loop communication service assurance - Introduction



- Release 16 (normative) 3GPP TS 28.535 (Requirements) and 28.536 (Stage 2 and 3):
 - Concept for open control loops and closed control loops**
 - Use cases, requirements and a model** for closed loop communication service assurance
- Release 17: Continuation work item on **Enhanced closed loop SLS assurance** (same TSs 28.535/536)

Definition and concept - Control loops (TS 28.535)

Control loops

The **basic principle**: Adjust the value of a measured or observed variable to equal the value of a desired goal

Open control loops

In an open control loop, the **human operator intervenes in one or more of the process steps** inside the loop, see Figure 4.2.3.1.

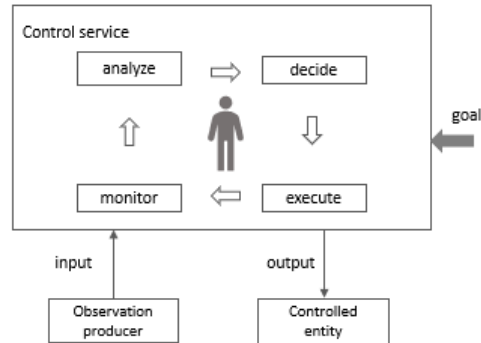

Figure 4.2.3.1: Open control loop entities

Closed control loops

In a closed control loop, there is **no direct involvement of a human operator** or other management entity in the control loop - the control loop is **fully automated**.

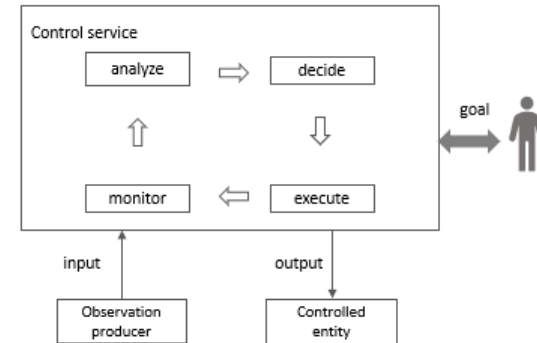

Figure 4.2.4.1: Closed control loop entities

Note: The content of this slide is under discussion in the TS 28.535.

Closed control loop governance and monitoring (TS 28.535)

- Communication service assurance relies on a set of management services that together provide the CSP with the capability to assure the communication service as per agreement (for example an SLS) with a CSC (e.g. enterprise).

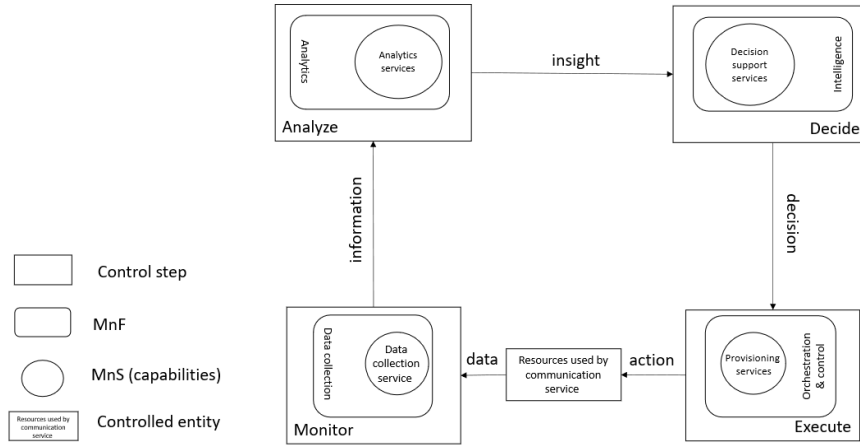

Figure 4.3.1: Overview of closed control loop information flows

- Closed control loop governance describes a set of capabilities to allow MnS consumer to govern closed control loop, including:

- Lifecycle management of closed control loop, including create, modify, activate/deactivate, delete closed control loop.
- Configure goals for closed control loop.

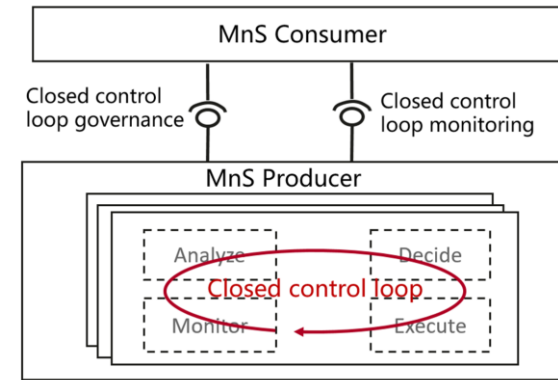

Figure 4.2.5.1 Closed control loop governance and monitoring

Note: The content of this slide is under discussion in the TS 28.535.

Management Data Analytics Service - Introduction



- 📶 **Objective: In conjunction with AI and ML techniques to bring intelligence and automation to the network service management and orchestration**
- 📶 Release 17: **Study** on concept, use case, requirements and solutions for Management Data Analytics Service (MDAS)
 - 📶 3GPP TR 28.809: “Study on enhancement of management data analytics”
- 📶 Release 17: Continuation (**normative**) **work item** for MDAS
 - 📶 3GPP draft TS 28.104: “Management and orchestration; Management Data Analytics”

32 MDA related use cases in 10 categories are recognized in the study phase.

6 Use cases, potential requirements and possible solutions

- ▷ 6.1 Coverage related issues
- ▷ 6.2 Resource related issues
- ▷ 6.3 SLS analysis related issues
- ▷ 6.4 Fault management related issues
- ▷ 6.5 Mobility management related issues
- ▷ 6.6 Energy efficiency related issues
- ▷ 6.7 Software management related issues
- ▷ 6.8 MDA assisted SON coordination
- ▷ 6.9 Security related issues
- ▷ 6.10 MDA management aspects

An example of MDA process where the ML model and the management data analysis module are residing in the MDAS producer

There are two kinds of processes for MDA, the process for ML model training and the process for management data analysis.

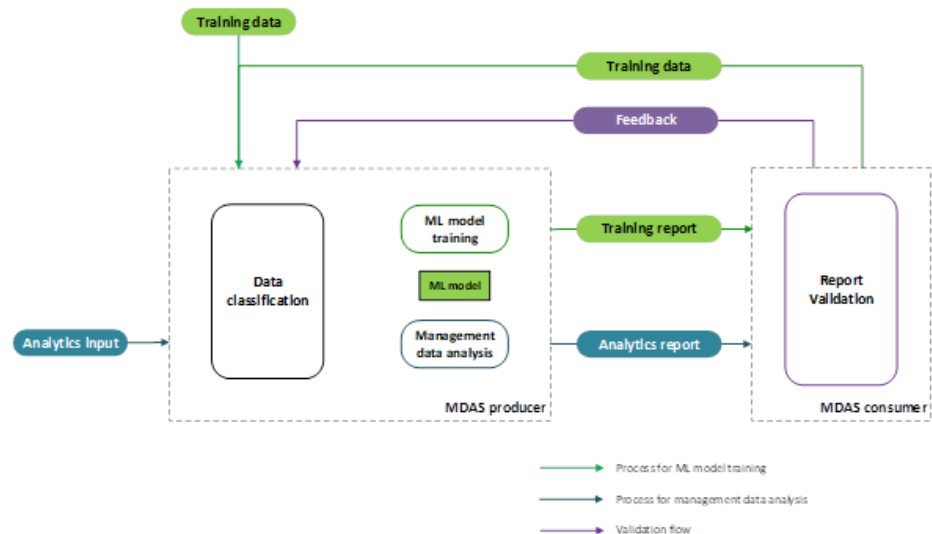

Figure 5.3-1: Example of MDA process

5G SON (Self Organizing Networks) (TS 28.313 / 28.541)

5G SON Concepts:

Centralized SON:

- 📶 Cross Domain-Centralized SON
- 📶 Domain-Centralized SON

Distributed SON

Hybrid SON.

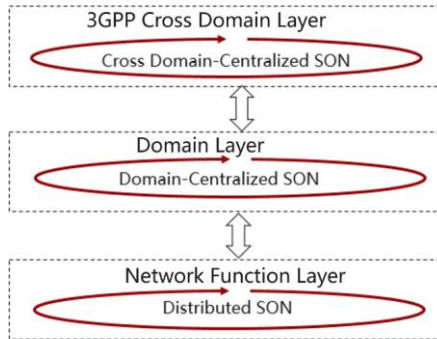

Figure 4.1.1-1: Overview of SON Framework

Management services for SON:

- 📶 RACH Optimization (Random Access Optimisation)
- 📶 MRO (Mobility Robustness Optimisation)
- 📶 ANR management in NG-RAN
- 📶 PCI configuration
- 📶 Load Balancing Optimization
- 📶 NSI resource allocation optimization
- 📶 Handover Optimization (separate WI)
- 📶 Capacity and Coverage Optimization (Note 1)
- 📶 Self-establishment of 3GPP NF (Note 1)

Note 1: The content of these two services is in the WI scope but not yet defined

3GPP SA5 External collaboration on E2E network slicing

3GPP SA5 has close collaboration on E2E network slicing with the following industry groups/SDOs:

- 🌿 **GSMA:** Align service profile with GSMA GST
- 🌿 **5G-ACIA:** Management exposure capability taking requirements related to Connected Industries and Automation Applications
- 🌿 **NGMN:** Network slicing concept and operators' requirements
- 🌿 **ETSI ZSM:** End to end network slicing procedure
- 🌿 **IETF:** Collaboration on Transport network
- 🌿 **ETSI NFV:** Collaboration on virtualization aspects

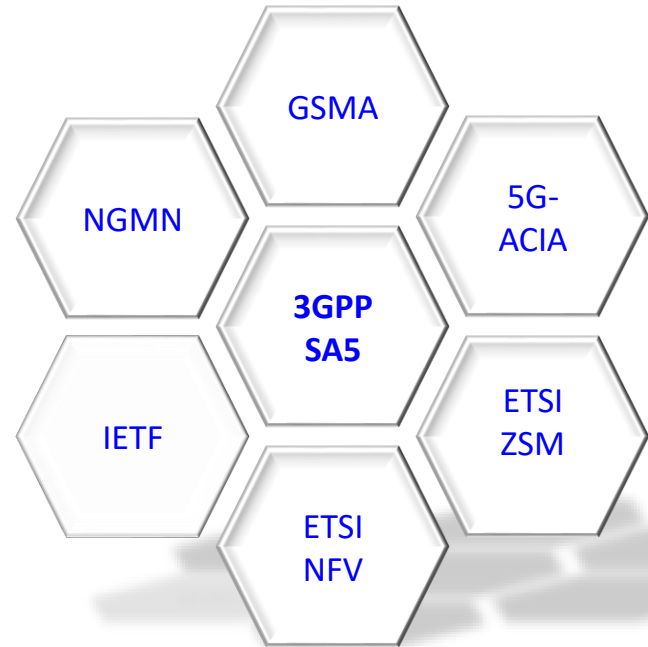

Summary

- SA5 already has experience of management of automation from the SON work in 4G/LTE, reused and further developed for 5G.
- SA5 now has 10 active work items related to autonomous networks.
- Reaching full autonomous networks is a step by step approach. SA5 is working on the management features and management services which support different levels of autonomy.
- 3GPP SA5 is currently collaborating with TM Forum, GSMA, NGMN, 5G-ACIA, ETSI ZSM, ETSI NFV on autonomous networks related work.
- Next SA5 meeting:

Meeting	Start date	End date
SA5#138-e	23 Aug 2021	31 Aug 2021

Thank you!

For more Information:



info@3gpp.org

thomas.tovinger@ericsson.com

zoulan@huawei.com



www.3gpp.org



portal.3gpp.org



The Standards People



ETSI ZSM009-1

Closed loop automation - Enablers







Presented
by:

Pedro Henrique Gomes
Ericsson | ETSI ZSM
rapporteur

For: **LFN Developer & Testing Forum**
June 2021

June 9th 2021

Motivation

-  Further specify how Closed Loop Automation can be realized within the ZSM framework
-  Improve the ZSM framework and specify new Management Services
 -  Use case-agnostic enablers
 -  Solutions to documented scenarios
-  Enable the creation and execution, as well as the integration and interoperability between closed loops within ZSM framework
-  Influence other SDOs and open-source projects



ZSM009 – Closed Loop (CL) Automation

ZSM009-1 – Enablers

- Enablers for closed loop automation for multiple use cases
- Mainly divided into:
 - CL Governance
 - CL Coordination
- Extension of ZSM framework with new management services and capabilities



ZSM009-2 – Solutions

- Solutions for end-to-end service and network automation
- Based primarily on the scenarios of ZSM001 (Scenarios and requirements)
- (Re)-uses the enablers specified in ZSM009-1



ZSM009-3 – Advanced topics

- Advanced topics, such as cognitive capabilities
- Adaptive automation
- Intent-driven closed loop automation



Closed loop in the ZSM framework – Services view

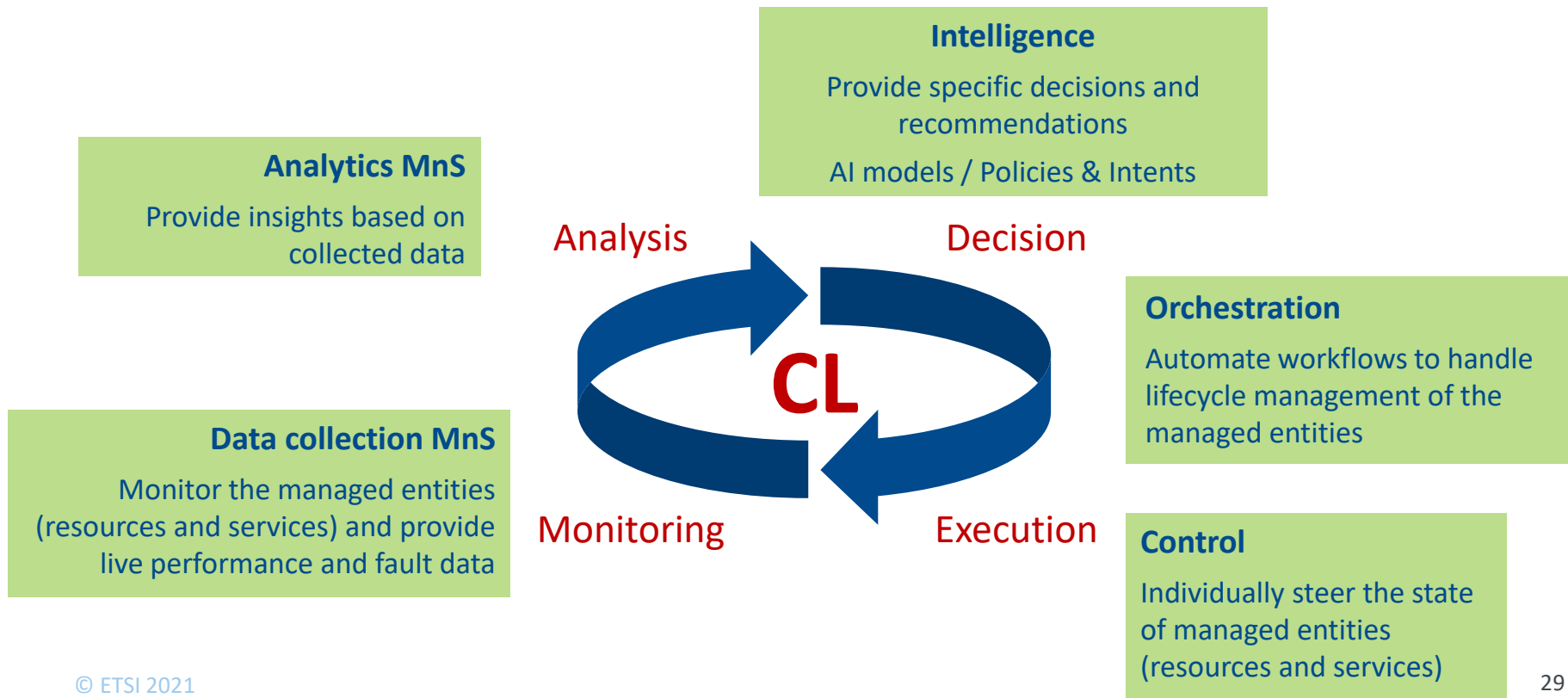

Closed loop in the ZSM framework - Deployment view

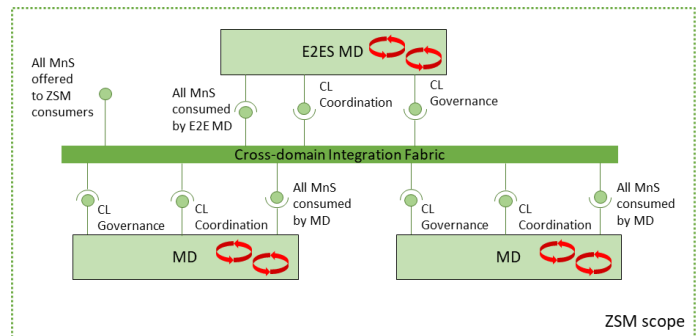
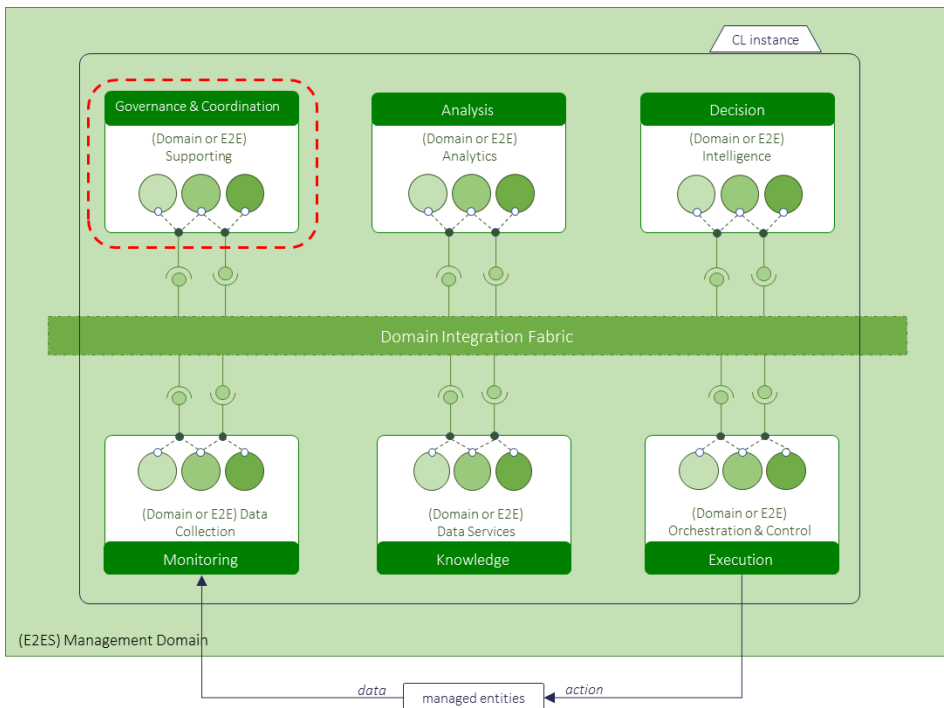

2 mandatory categories of management services externally visible:

- Closed Loop Governance
- Closed Loop Coordination

Closed loop Governance

- ✔ Closed loop Governance is the set of capabilities that allow external entities to manage the life cycle and to configure the behaviour of the closed loops.
- ✔ Governance can also be used to retrieve information about the status and performance of the closed loop.

Types of capabilities:

- Management of the lifecycle of the CLs
- Management of CL models
- Configuration of policies, rules, triggers and priorities for the closed loops;
- Conveying status and performance information of the CLs.

- ✔ Closed loop governance can be done by authorized entities inside or outside the management domains where the CLs are running

Closed loop Governance

CL Lifecycle management – phases and activities

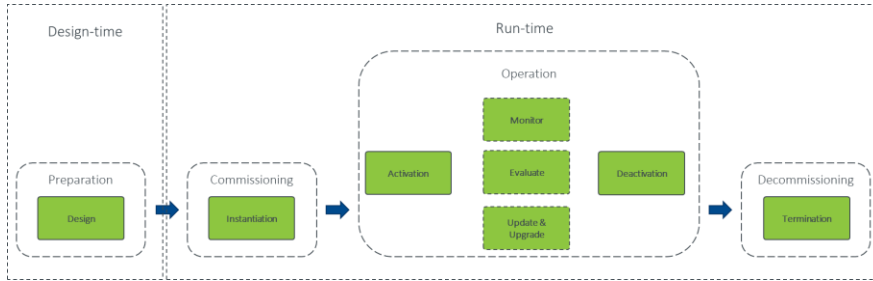

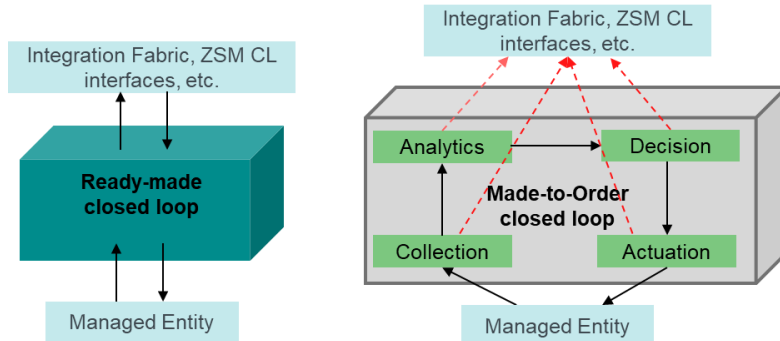

Closed loop types

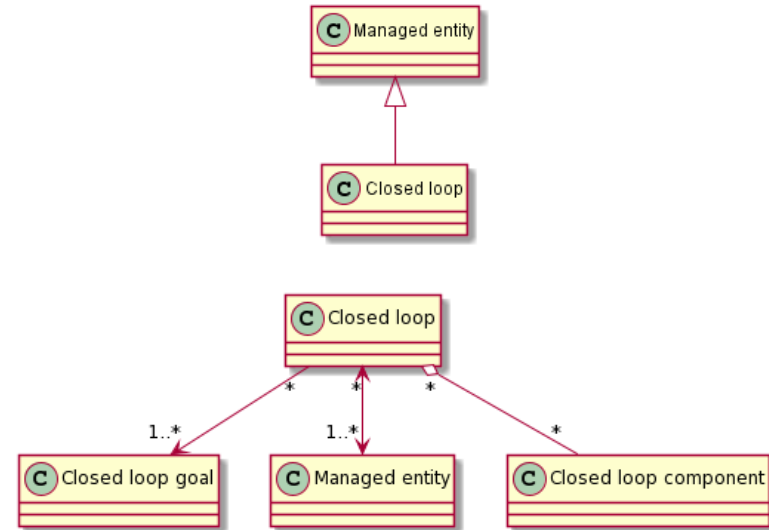

Closed loops (meta)model



Closed loop Coordination

-  CL coordination is a set of capabilities that allows multiple CLs to be coordinated, with the main objective of improving their performance and the fulfilment of their goals.
-  CL coordination involves different types of interactions between multiple closed loops during their run-time

-  Coordination of conflicting CLs is an important part of CL coordination capabilities. Conflicts between CLs can negatively impact their operations. Conflicts can occur between two or more CLs, involving the same or different sets of managed entities

Closed loop coordination services

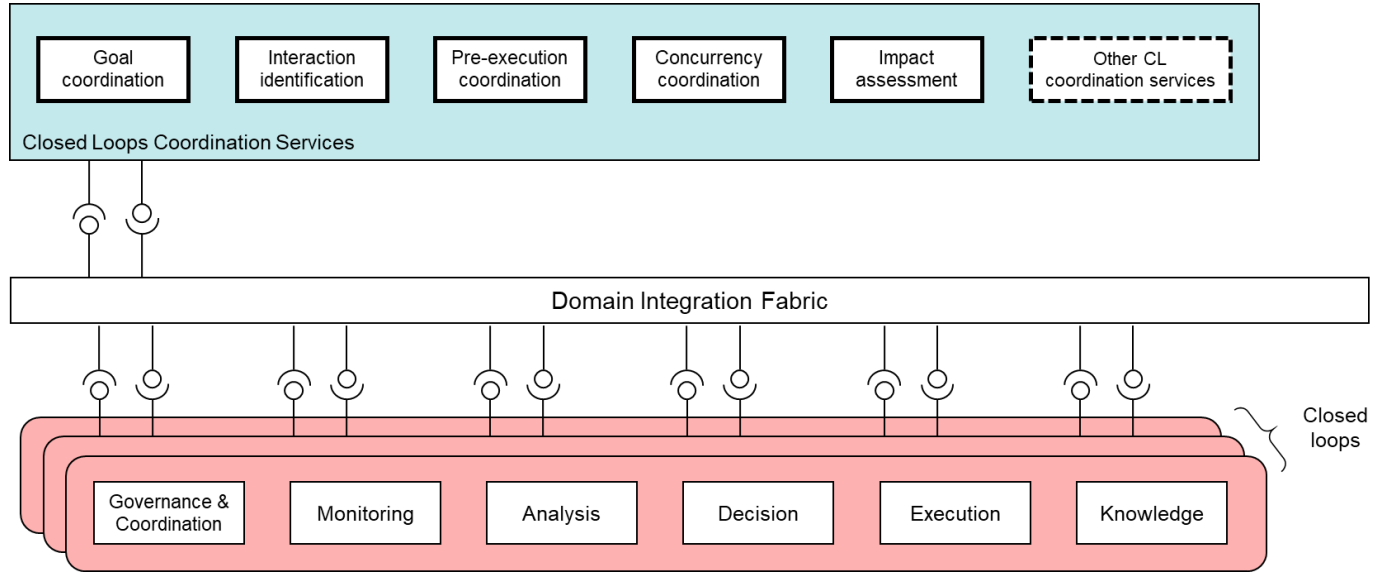

Typical timeline of CL coordination services

The closed loop coordination services can interact with each other in different ways and at different times

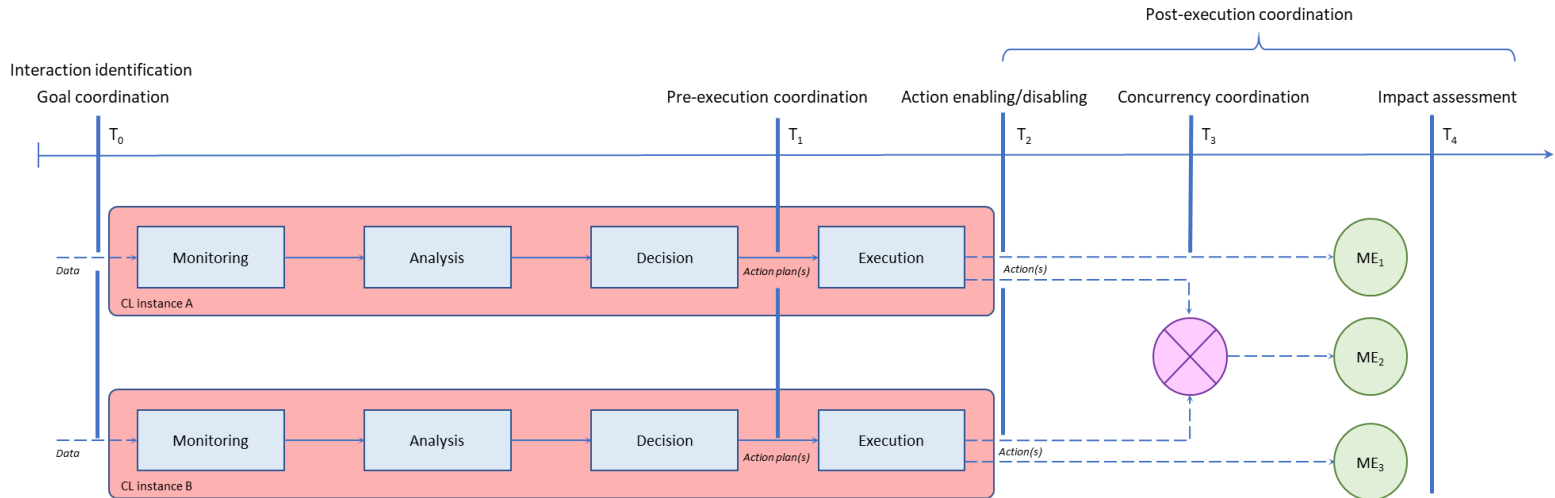



Author's contact

pedro.henrique.gomes@ericsson.com

More information on ETSI ZSM

ZSM Technology Page: <http://www.etsi.org/zsm>

ZSM Wiki: <https://zsmwiki.etsi.org/>

ZSM Open Area (Draft specs): <http://docbox.etsi.org/ISG/ZSM/Open>

ZSM Portal (members' working area): <http://portal.etsi.org/zsm>



Closed Control-Loop Automation @ IRTF NMRG

IRTF NMRG

Chairs: Laurent Ciavaglia, Jérôme François

Secretaries: Jéferson Campos Nobre, Pedro Martinez-Julia



NMRG - Network Management Research Group

- A forum for researchers to explore new technologies for the management of the Internet
- An activity of the IRTF – Internet Research Task Force
 - Not a standardization group
 - But “privileged link” with IETF
- Open
 - Mailing list
 - Meets 3-4 times / year, co-located with IETF meetings, IM/NOMS conferences, and ad-hoc/topical meetings
 - Virtual “interim” meetings (~monthly basis)

Research agenda overview

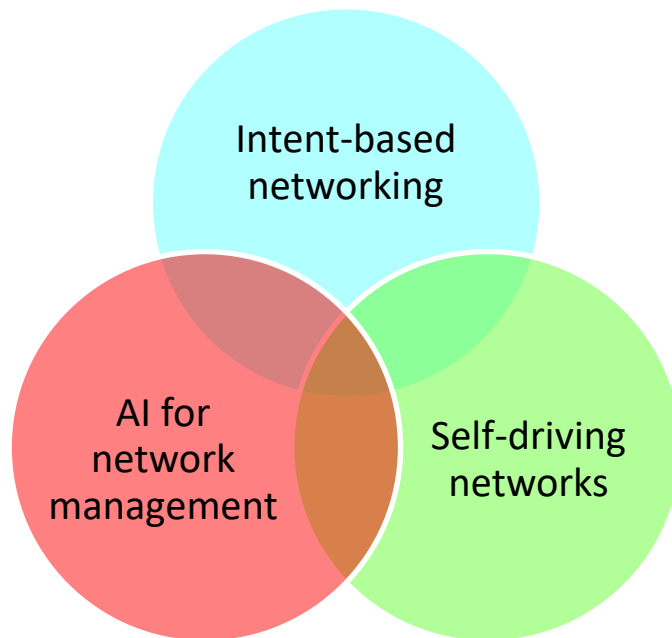

More details on charter and milestones at:
<https://datatracker.ietf.org/rg/nmrg/about>

Closed loops @NMRG...

Closed loops as a core component of

- **Autonomic Networking 2013-2014**
→ [RFC7575](#) + [RFC7576](#) and creation of [ANIMA WG](#)
- **Intent-Based Networking 2016-present**
→ Seminal document on Concepts and Definitions
<https://datatracker.ietf.org/doc/draft-irtf-nmrg-ibn-concepts-definitions/>

High-level IBN Principles

- **Single source of truth**
Important to capture drift, ensure system convergence
- **One touch but not one shot**
It may take iterations and interactions to arrive at desired intent, resolve ambiguities, avoid unintended consequences
- **Autonomy and oversight**
System conducts tasks on its own; users are given the necessary tools to retain an understanding of current state and what is happening
- **Learning**
System can assess effectiveness of its own actions and improve in order to optimize outcomes and adapt to dynamic conditions and changing context
- **Explainability**
System is able explain its actions and reason about their effectiveness
- **Abstraction**
At each level of interaction, Information is presented with / adapted to provide the “right” abstraction
Users do not need to be concerned with how intent is mapped into lower-level artefacts

Closed Loops & Intent Lifecycle

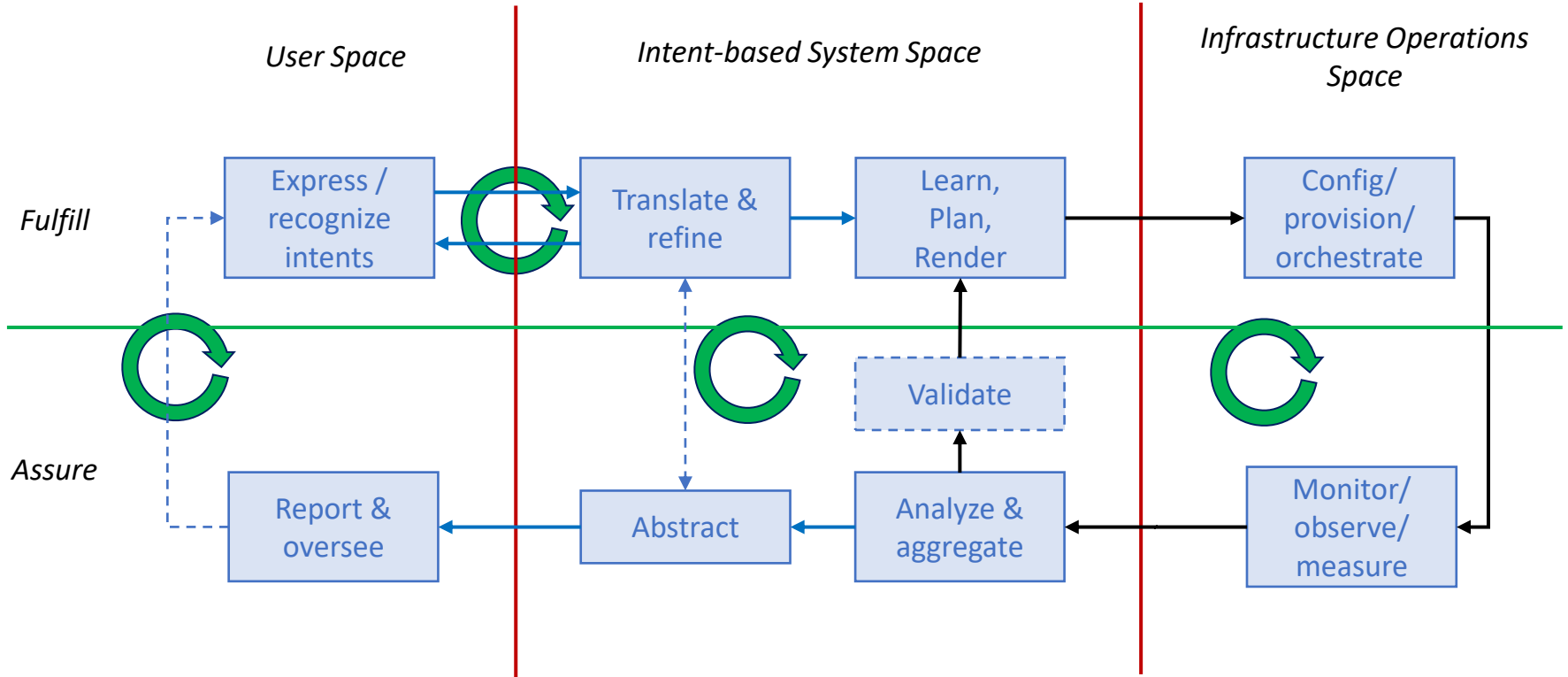

Some IBN Research Challenges...

- **NMRG is a research group, after all...**
- **Intent interfaces**
System is to infer the intent of the user (Intent \neq YANG, CLI, RPC, config)
Human-machine interactions: facilitate interrogation/interview-style interactions, clarification, alternative selection, intent playback, iterative intent refinement
- **Explanation**
Have IBN explain actions to facilitate troubleshooting, improve confidence, retain control – compare ML
- **IBN Metrics**
Assess effectiveness of IBN outcomes, ability to learn, adapt, progress



LFN Developer & Testing Forum

TOSCA Control Loops in ONAP

Liam Fallon (Ericsson Software Technology)

Background

- ONAP Architecture Inspired by OODA/MEDA and Autonomic Management research
- Bottom-Up Approach
 - Get Use Cases working
 - Generalize Definitions
 - Generalize Implementations
 - Keep Use Cases Working
 - Implement new Use Cases
- Current work is to generalize the design time and run time Control Loop support in ONAP
- Aim is to provide a framework that can be applied to do Life Cycle Management of a set of cooperating executing entities working together as an application
- See:
<https://wiki.onap.org/display/DW/TOSCA+Defined+Control+Loops%3A+Architecture+and+Design>

Architecture

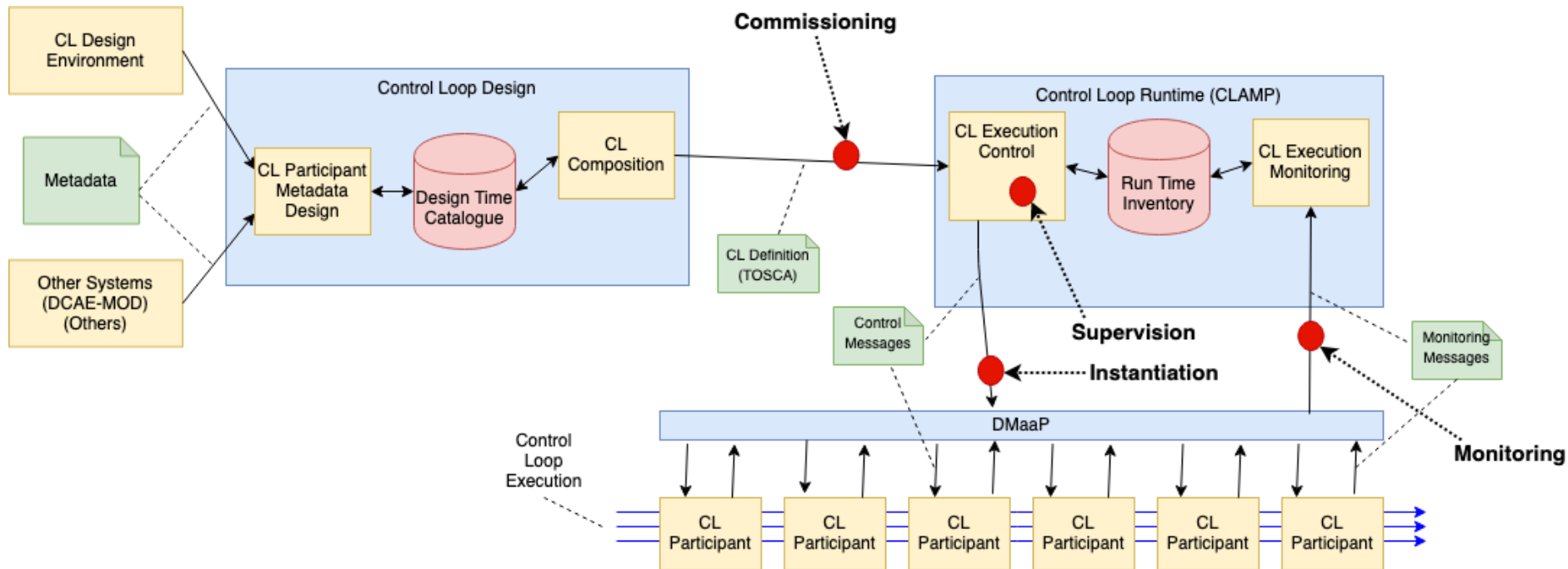

Design Time and Runtime Concepts

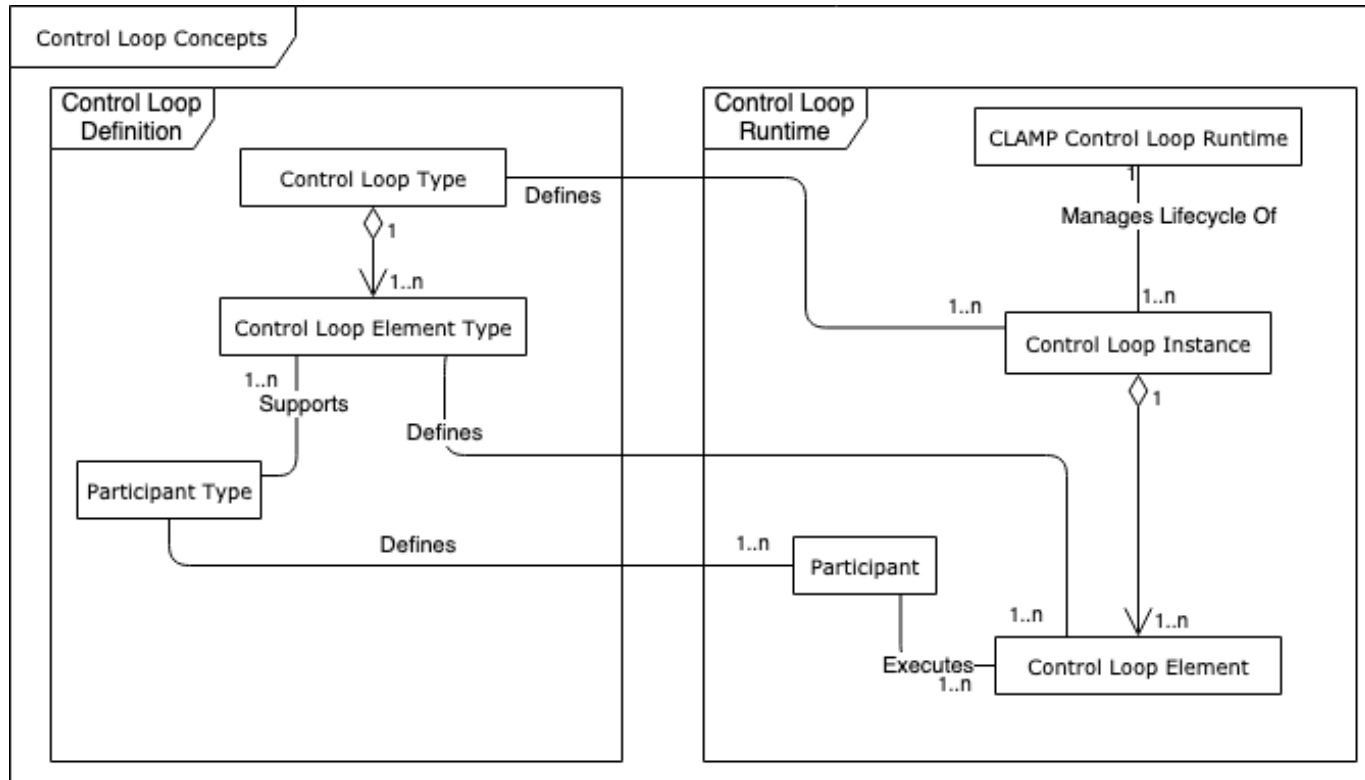

Current Status

- PoC built that demonstrates the concept working to spin up and take down Control Loops
- Framework being integrated into ONAP for the Istanbul release (Q3 2021)
 - Productization of the framework
 - Adaptations to CLAMP GUI
 - Better support of Control Loop Parameterization
 - Participants for Kubernetes and HTTP as well as Policy and DCAE



OLF NETWORKING

LFN Developer & Testing Forum



OLF NETWORKING

LFN Developer & Testing Forum

Q&A