



# OLF NETWORKING

---

LFN Developer & Testing Forum

## **Technical Community Coordination - Generic Network Management**

**Cooperation with SDOs**

Magnus Buhrgard ([magnus.buhrgard@ericsson.com](mailto:magnus.buhrgard@ericsson.com))

Technical Community Coordinator for Generic Network Management

- TM Forum Autonomous Networks
  - Intent Driven Management
  - TM Forum Multi-SDO Initiative - Autonomous Networks
- ETSI ZSM - ONAP
  - PoC program
  - PoC on ONAP's Intent-based Cloud Leased Line Solution – Henry Yu
  - PoC on Control Loops
- ITU Focus Group on Autonomous Network (ITU-FG AN)
- GSMA - Operator Platform Group

- **TM Forum Autonomous Networks**
  - Intent Driven Management
  - TM Forum Multi-SDO Initiative - Autonomous Networks
- ETSI ZSM - ONAP
  - PoC program
  - PoC on ONAP's Intent-based Cloud Leased Line Solution – Henry Yu
  - PoC on Control Loops
- ITU Focus Group on Autonomous Network (ITU-FG AN)
- GSMA - Operator Platform Group

Some published documents:

- [IG1193 Cross-Industry Autonomous Networks – Vision and Roadmap v1.0](#)
- [IG1218 Autonomous Networks – Business Requirements & Architecture v1.1.0](#)
- [IG1229 Guiding Principles for building and measuring Autonomous Network Solutions v1.0](#)
- [IG1230 Autonomous Networks Technical Architecture v1.0.0](#)
- [IG1253C Intent Life Cycle Management and Interface v1.0.0](#)

# Previous Autonomous Networks Webinar

Global Architecture Forum

## Autonomous Networks with intent- driven operations

tmforum  
labs

November 23, 2021 | 13:00 GMT

WATCH ON-DEMAND

Watch this Global Architecture Forum webinar to learn how TM Forum members have developed a reference architecture for autonomic networks and a comprehensive approach to intent modelling and intent interfaces. Our host, Aaron Boasman-Patel, TM Forum, is joined by project leads Kevin McDonnell, Huawei and Jörg Niemöller, Ericsson to discuss the benefits of these proposals for realizing an autonomous network.

They will outline:

- What is the autonomous networks reference architecture?
- What are intent-driven operations?
- How will service providers use them?



Kevin McDonnell  
Senior Director,  
Intelligent Automation  
Huawei



Jörg Niemöller  
Expert of Analytics and  
Customer Experience  
Ericsson



Aaron Boasman Patel  
VP, AI & Customer Experience  
TM Forum

[TM Forum  
Autonomous  
Networks  
Webinar](#)

# TM Forum Presentation

## Intent Management Interfaces and APIs

### Objectives

- Communicate status of TM Forum Intent work
- Identify opportunities for collaboration Industry Acceleration on Intent based Interfaces, APIs models/ontologies.

### Agenda

- Introduction (5mins)
- Context of Intent management Interfaces APIs - Kevin McDonnell (5 mins)
- Intent Management Interfaces proposals (50 mins)
  - IG1253 Intent Management Architecture, models/ontologies and interfaces - Jörg Niemöller
  - TMF 721 Intent API -- Kevin McDonnell
- Open discussion, feedback, and next steps (30 mins)

**January 14<sup>th</sup> at 13:00 UTC (90mins) - [2022-01-14 M-SDO Open Meeting: TM Forum Intent Management interfaces and API Presentation - AN-SDO Collaboration](#)**

It will be recorded and put in the meeting minutes on the AN workspace (link above)

# TM Forum Multi-SDO Initiative

- TM Forum initiated an Industry-wide Multi-SDO Initiative - Autonomous Networks
- Multiple Standards Developing Organizations (SDOs) announce working together for an aligned vision of AN with better collaboration between Industry Stakeholders.
- “The long journey towards autonomy has only just begun and the industry needs standards to guide the best way to achieve Autonomous Networks (AN).”
- “Ideally, these standards should fit well together and form a coherent whole.”
- Initially the proposal was to create joint documents - It is now set up as a series of open meetings

SDO	Group/Project	SDO	Role
3GPP	SA5	IETF	WG on AN
CCSA	TC7	ITU-T	FG-AN
ETSI	ENI, F5G, MEC, NFV, PDL, TC INT/AFI, ZSM	Linux Foundation*	ONAP
GSMA	Future Networks	NGMN	Automation
IEEE	Future Networks	TM Forum	AN Project

\*Open Source Community

Meeting schedule is updated at [Multi-SDO AN Meeting Schedules](#)

- TM Forum Autonomous Networks
  - Intent Driven Management
  - TM Forum Multi-SDO Initiative - Autonomous Networks
- ETSI ZSM - ONAP
  - PoC program
  - PoC on ONAP's Intent-based Cloud Leased Line Solution – Henry Yu
  - PoC on Control Loops
- ITU Focus Group on Autonomous Network (ITU-FG AN)
- GSMA - Operator Platform Group



# ETSI ZSM – Proof of Concept Framework

- ETSI ISG ZSM has defined a framework to be used by to coordinate and promote multi stakeholder Proofs of Concept (PoC) projects illustrating key aspects of ZSM.
- Proofs of Concept are an important tool to demonstrate the viability of a new technology during its early days and or pre-standardization phase.
- The main objectives of the ZSM PoC framework are:
  - to ensure the PoC projects are scoped around relevant topics for ISG ZSM that require from-the-field input;
  - to ensure that the PoC results, lessons learnt and identified gaps are feedback to ISG ZSM;
  - to build confidence on the viability of ZSM;
  - to encourage the development of a diverse and open ecosystem by fostering the integration of components from different players;
  - to support standardization and industry promotion activities of ISG ZSM.
- Present PoC topics
  - [Automation in Multi-Stakeholder Ecosystems](#)
  - [Intent-driven Closed-Loop automation](#)
  - [Cross-domain user-driven E2E services](#)

# ETSI ZSM Architecture

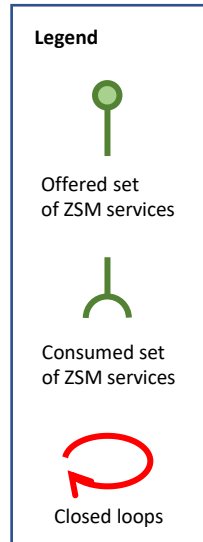
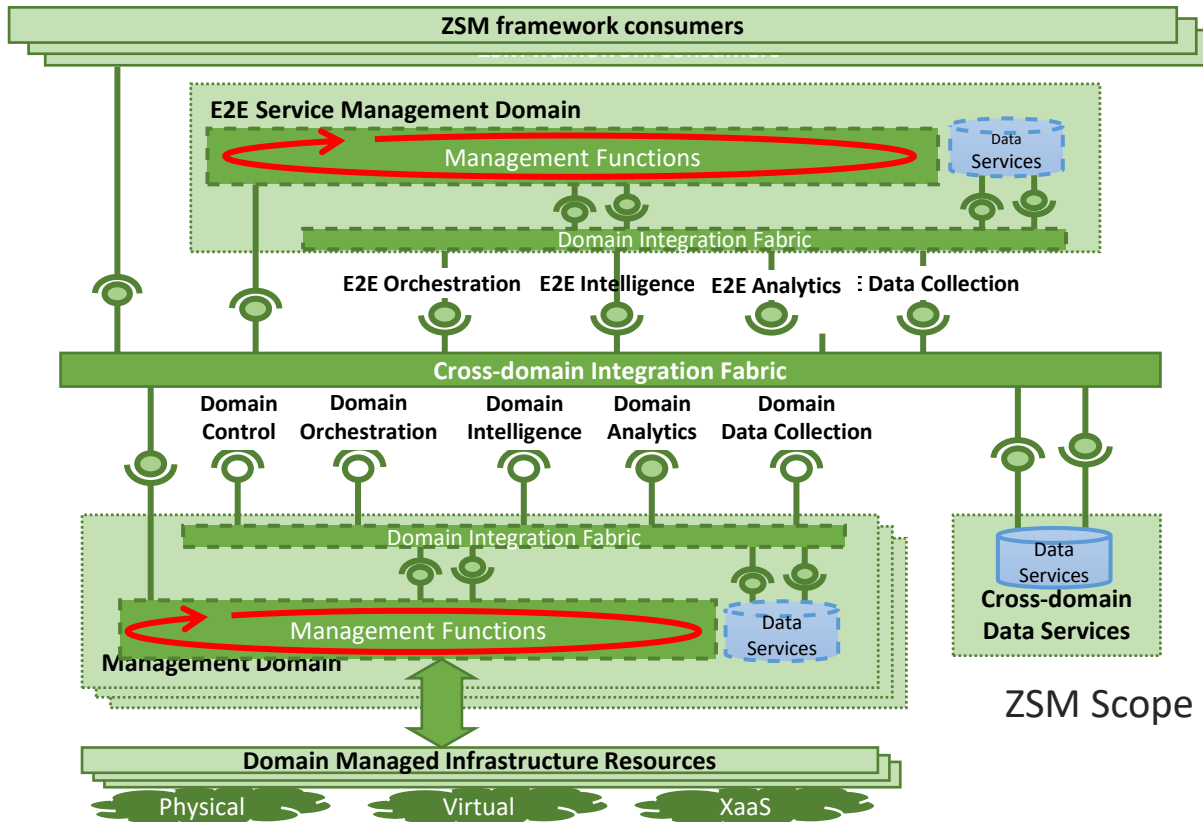

# Some ONAP and ETSI ZSM touchpoints

- ZSM002 – Reference Architecture – a service based E2E automation management architecture
- ZSM003 provides a specification of E2E Network Slicing management solutions and related management interfaces – used as the architectural framework for ONAP Intent-based Cloud Leased Line Solution
- ZSM008 - Cross-domain E2E Service LCM - Service onboarding, Service fulfillment, Service assurance
- ZSM009 – Closed Loop Automation – governance and coordination of multiple loops, solutions, advanced features. Zero touch case of Control Loops in ONAP.
- ZSM011 - Intent-driven Autonomous Network Study – related to ONAP *Intent framework and intent modeling* Use Case

- TM Forum Autonomous Networks
  - Intent Driven Management
  - TM Forum Multi-SDO Initiative - Autonomous Networks
- ETSI ZSM - ONAP
  - PoC program
  - PoC on ONAP's Intent-based Cloud Leased Line Solution – Henry Yu
  - PoC on Control Loops
- ITU Focus Group on Autonomous Network (ITU-FG AN)
- GSMA - Operator Platform Group



# **OLF** NETWORKING

---

LFN Developer & Testing Forum

## **ETSI ZSM PoC on ONAP's Intent-based Cloud Leased Line Solution**

Henry Yu (Huawei)

Dong Wang (China Telecom)

# Contents

- Background of Intent and ZSM architecture
- Intent-based Cloud Leased Line solution on ONAP
- ZSM PoCs on ONAP

# Intent-based Networking (IBN) Concepts

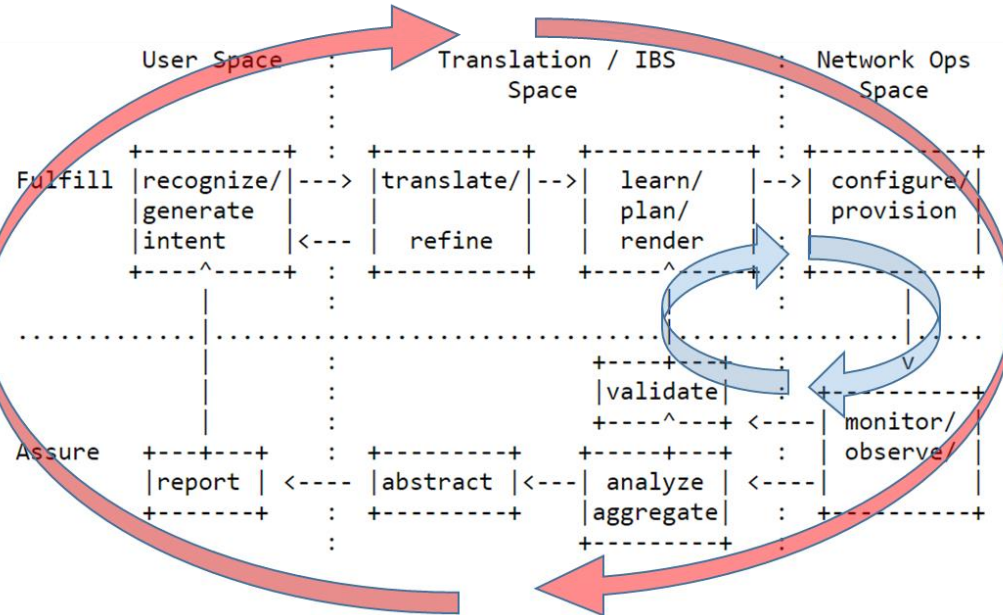

Figure 1: Intent Life-cycle

Based on draft-irtf-nmrg-ibn-concepts-definitions [1]:

- **Intent Fulfillment**

- Intent ingestion and interaction with users
- Intent translation
- Orchestration: configure/provision

- **Intent Assurance**

- Performance data monitoring
- Intent compliance assessment
  - continuously monitor & compare actual vs. intended configs
- Intent compliance actions: learn/plan/render
- Abstraction and reporting

- **Intent Control Loops**

- “Inner” loop: classic zero-touch closed loop within a management domain
- “Outer” loop: E2E service manage domain closed loop; intent exchange – involves end user

[1] <https://tools.ietf.org/html/draft-irtf-nmrg-ibn-concepts-definitions-06>

# Implement IBN Using ZSM Architecture

- The “outer” intent loop may be realized by ZSM’s E2E MD, which consumes and composes services provided by other ZSM MDs (e.g., Transport MD)
- The “inner” intent loop may be realized by Transport MD

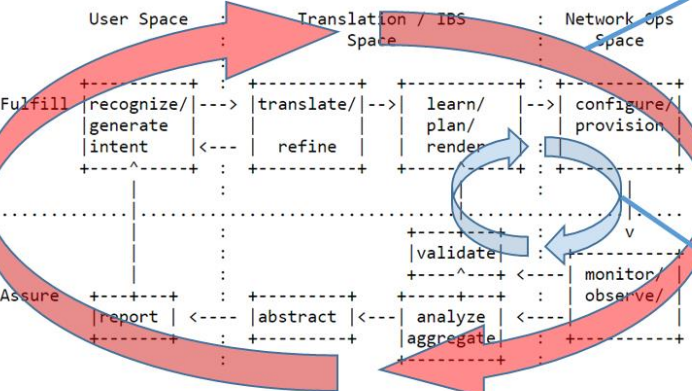
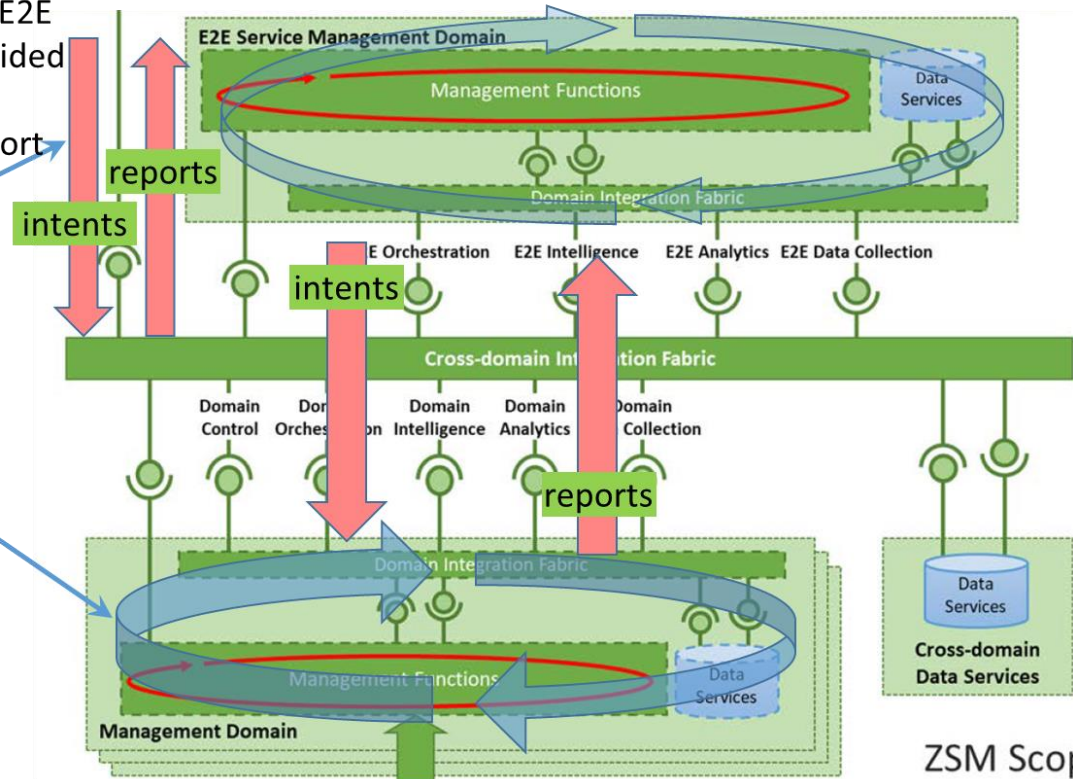

Figure 1: Intent Life-cycle

Source: draft-irtf-nmrg-ibn-concepts-definitions

ZSM Architecture (Source: ZSM 002)

ZSM Scope



# Intent-based Cloud Leased Line on ONAP

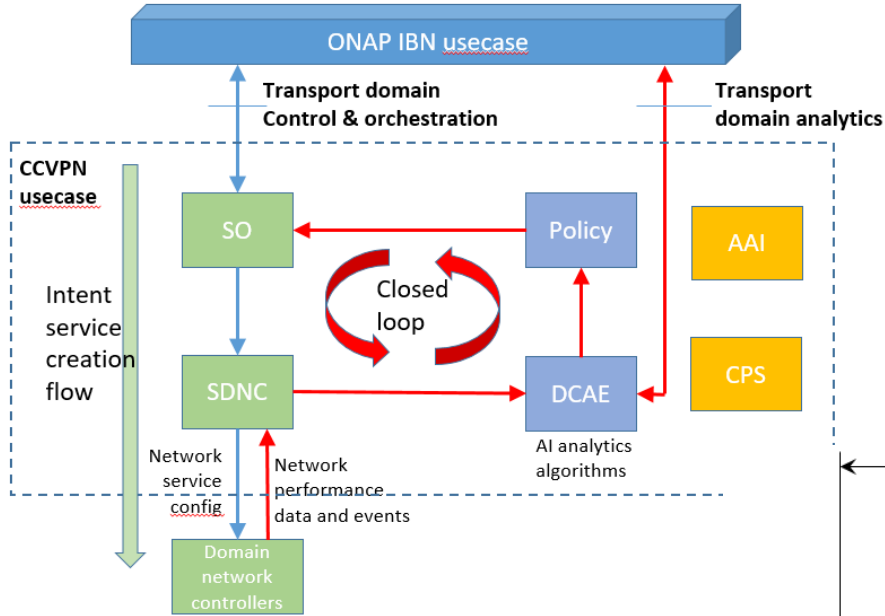

## ONAP implementation of Intent-based Cloud Leased Line

## Network configuration of Cloud Leased Line, which is automated by ONAP

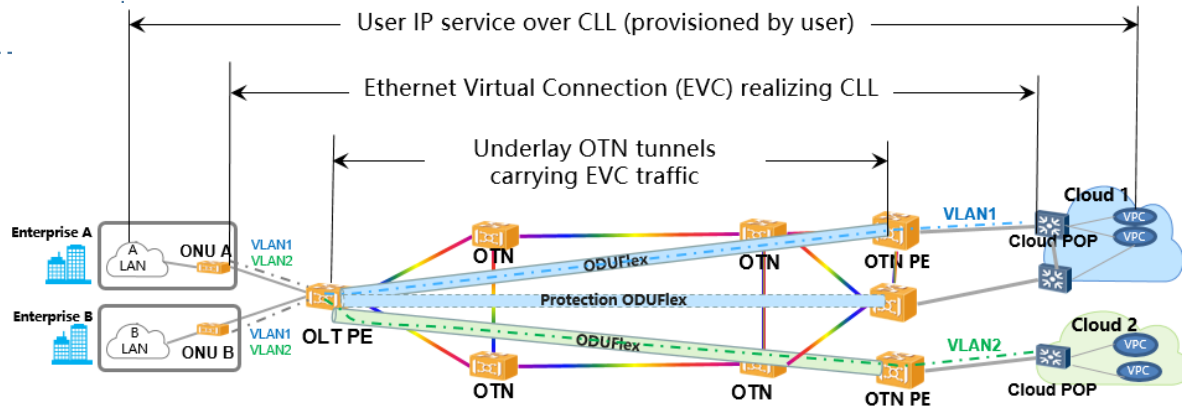

# ETSI ZSM and MSDO Collaboration

- ZSM collaborates with multiple SDOs and open source communities on network automation standards and solutions.
- ZSM also coordinates PoCs illustrating key aspects of the automation technology and solutions.
- We are collaborating with ZSM to perform a PoC on ONAP's Intent-based CLL solution.

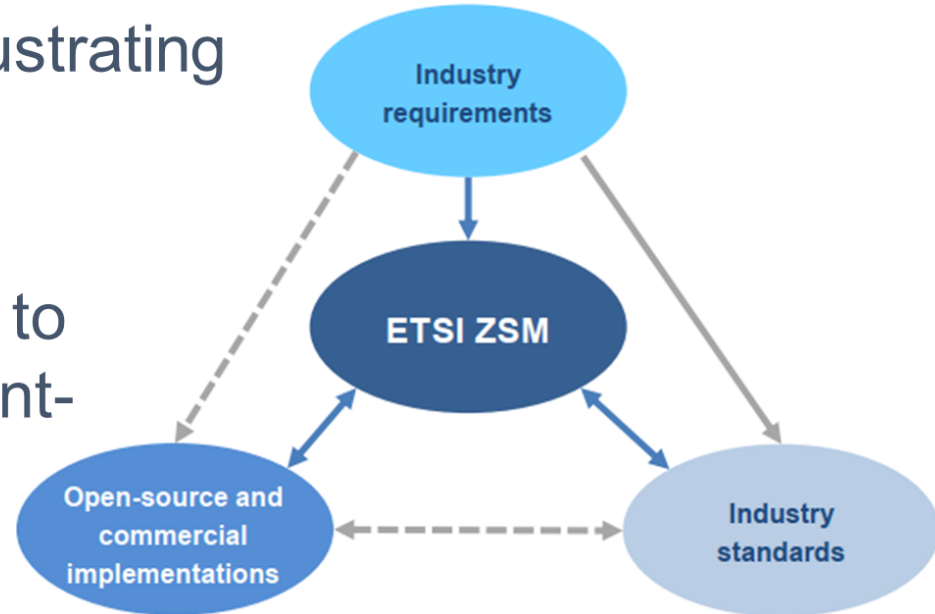

# ZSM PoC Proposal

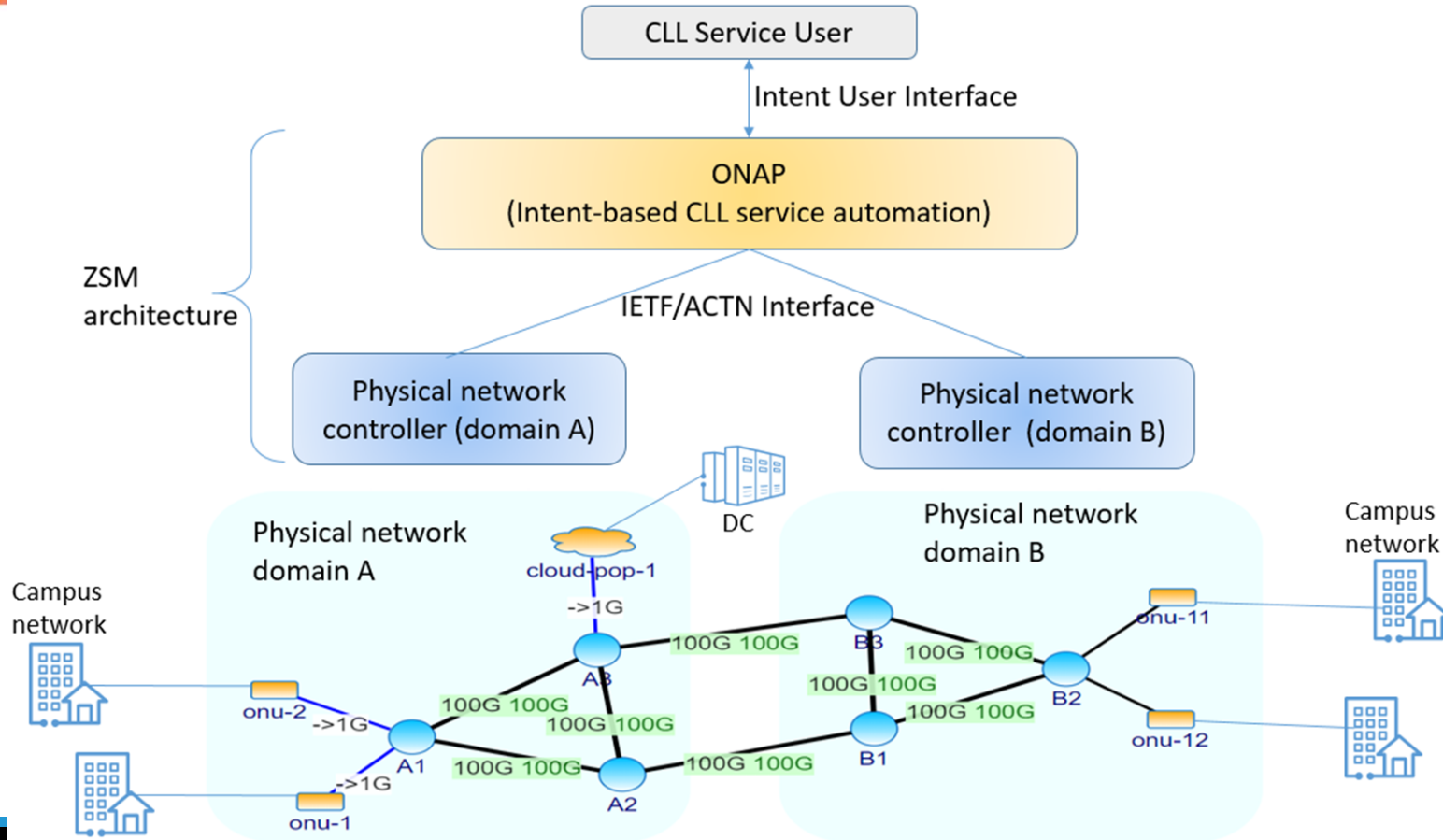

- TM Forum Autonomous Networks
  - Intent Driven Management
  - TM Forum Multi-SDO Initiative - Autonomous Networks
- ETSI ZSM - ONAP
  - PoC program
  - PoC on ONAP's Intent-based Cloud Leased Line Solution – Henry Yu
  - PoC on Control Loops
- ITU Focus Group on Autonomous Network (ITU-FG AN)
- GSMA - Operator Platform Group

# CL in ZSM framework - Functional view

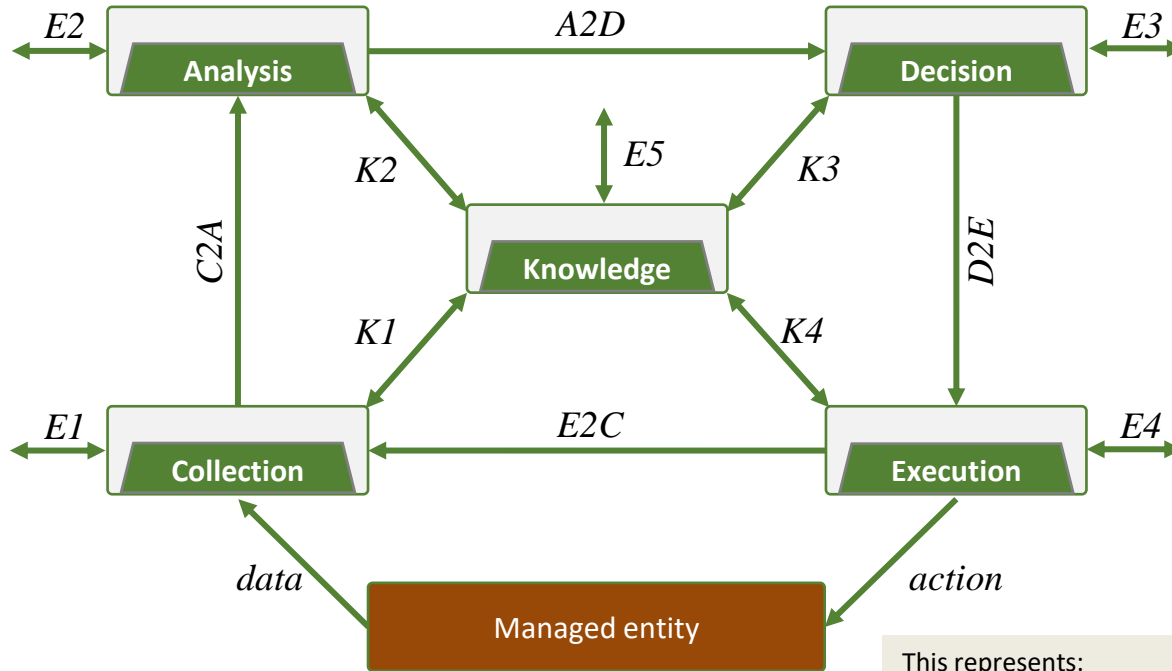

This represents:  
Managed resource, or  
Managed service, or  
Managed closed loop

# Closed-loop governance

- Set of capabilities for external entities to manage the CL models and the lifecycle of CLs (design-time AND run-time);
- Configuration of policies, rules, triggers and priorities for the CLs;
- Status and performance information of the CLs.

## CL LCM – Phases and activities

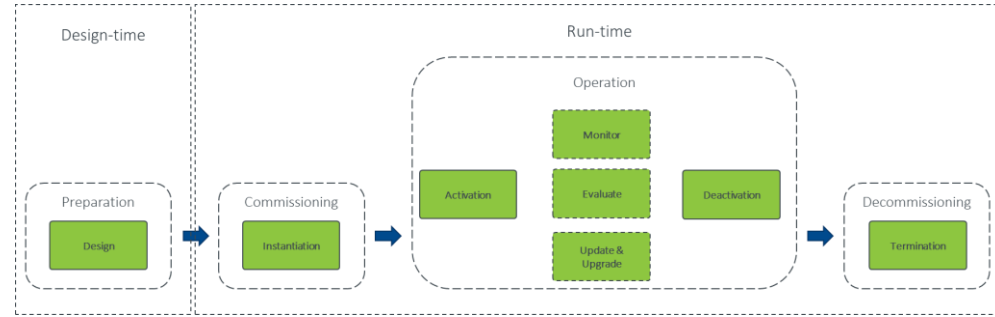

## Closed loops (meta)model

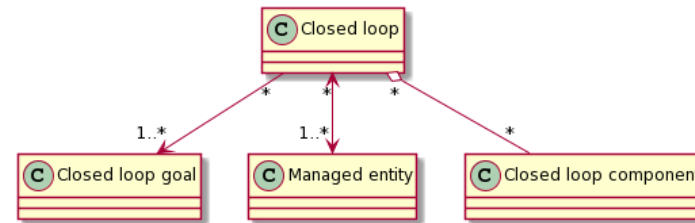

# CL Target Architecture

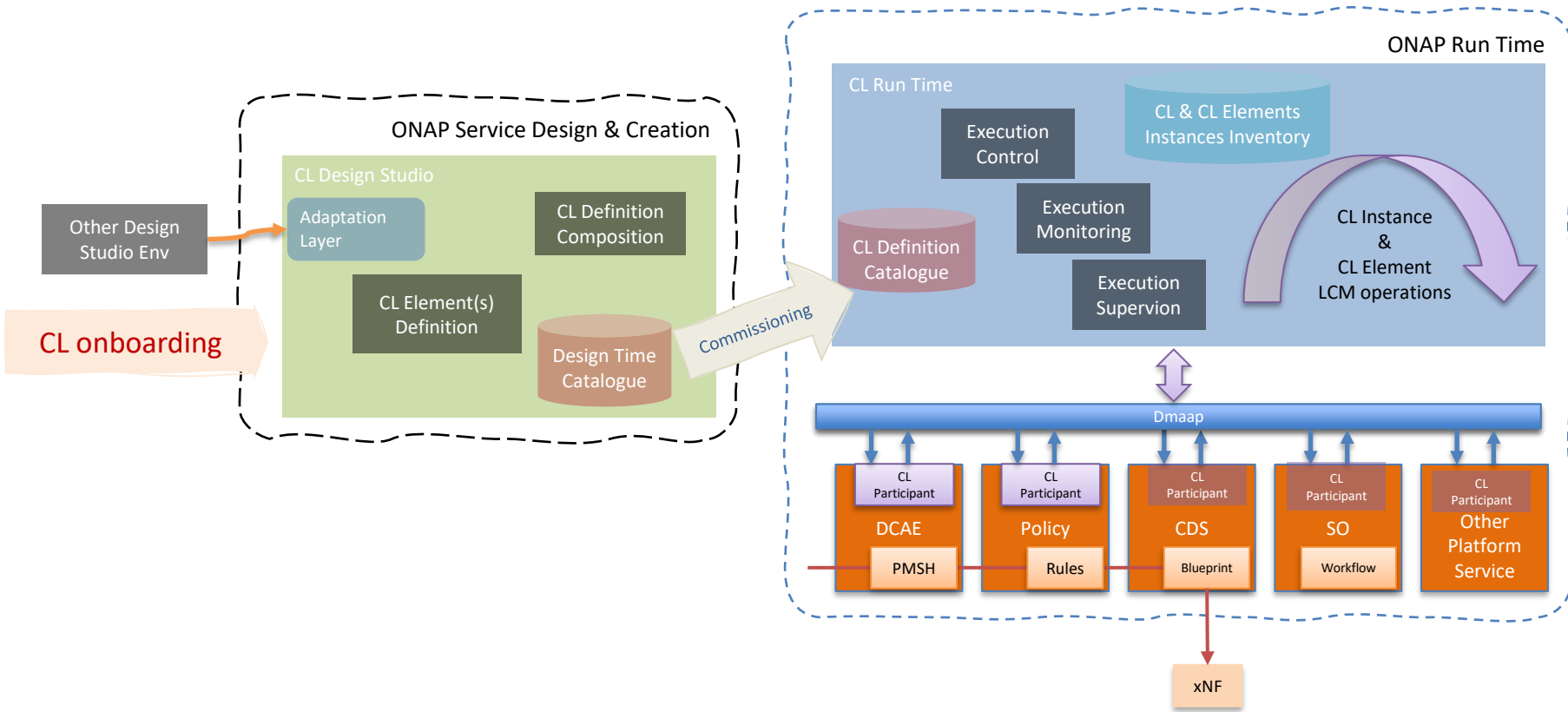

# Terminology and Concepts

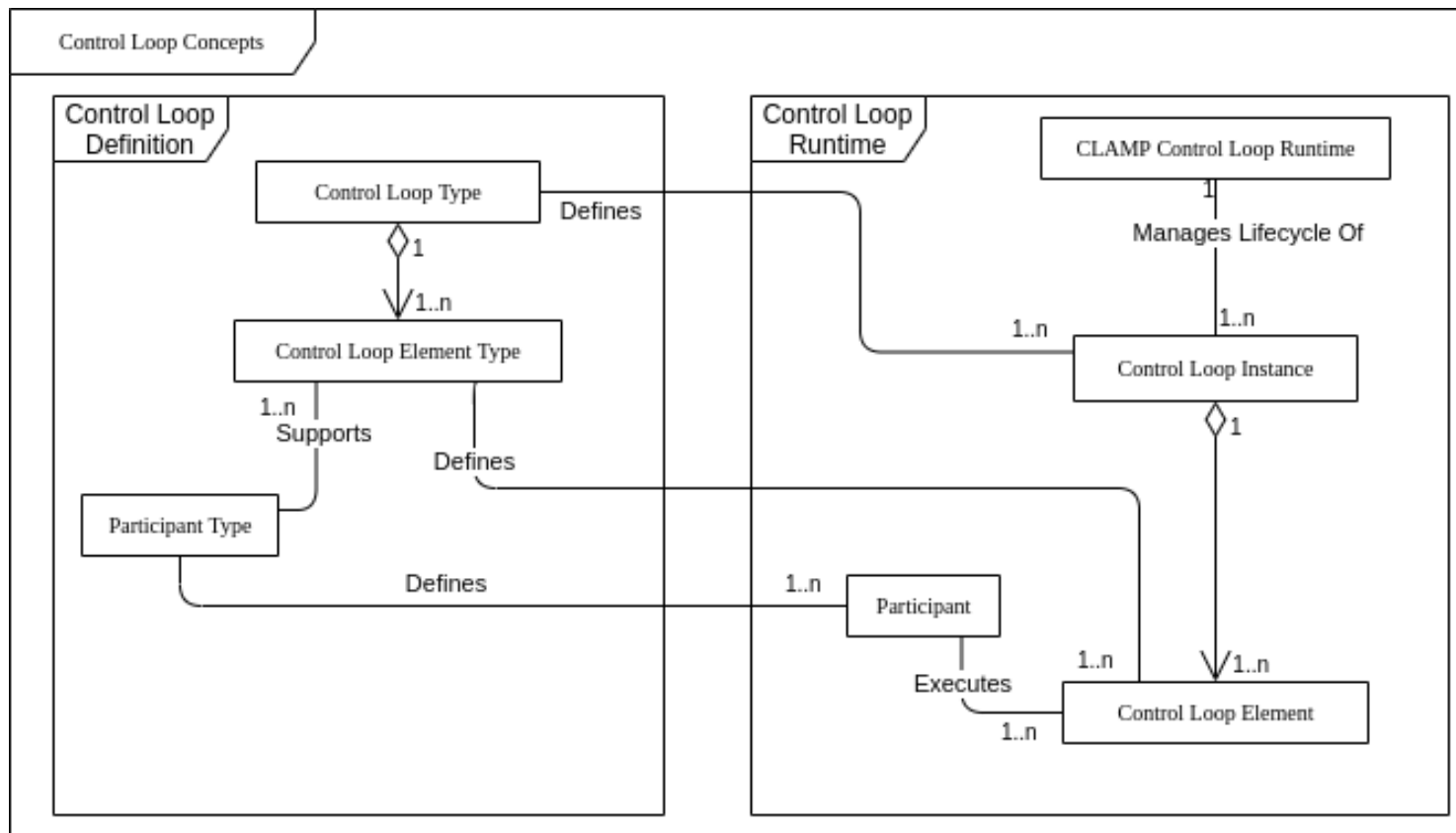



# Control Loop Life Cycle Management

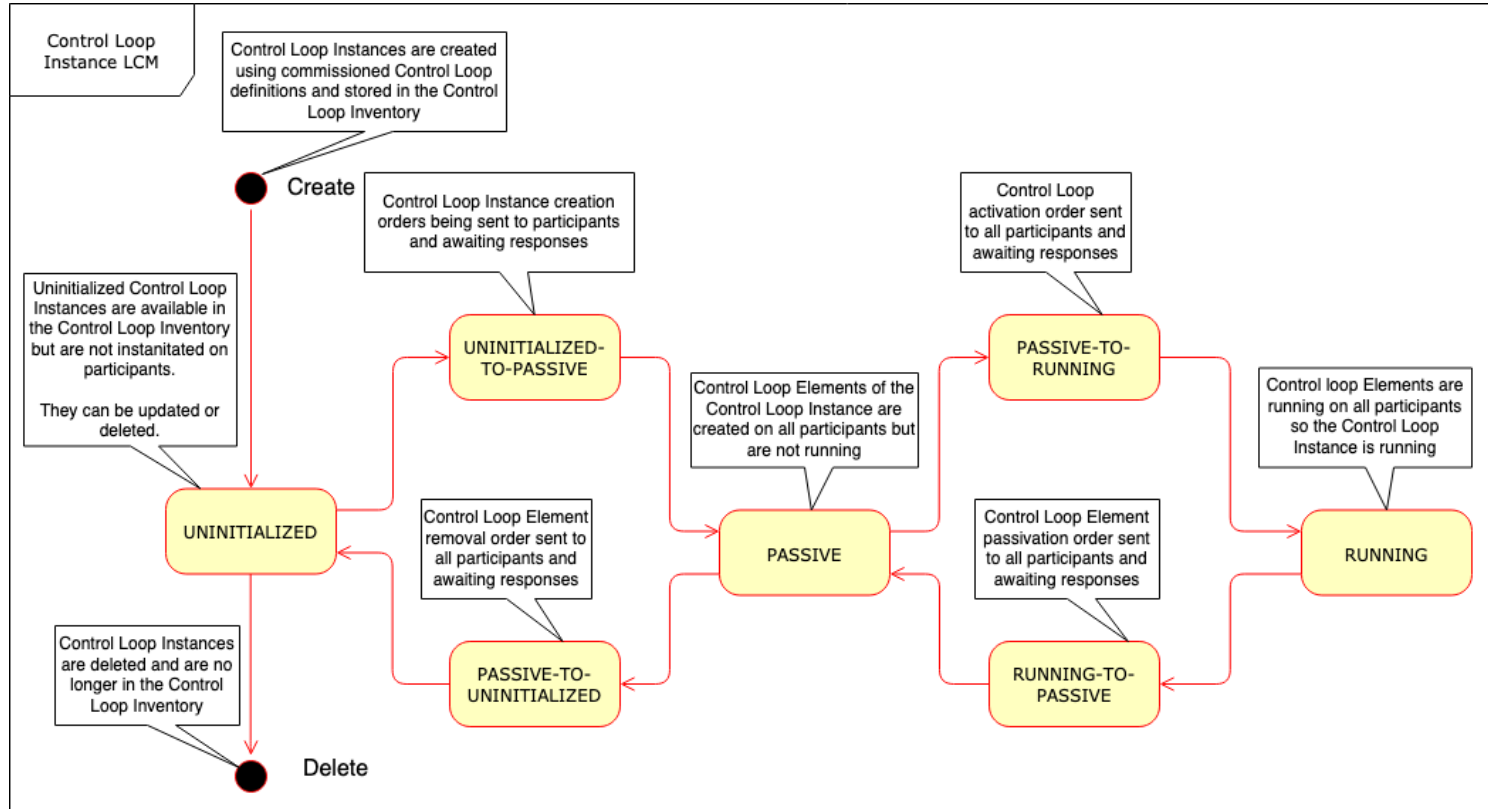

- TM Forum Autonomous Networks
  - Intent Driven Management
  - TM Forum Multi-SDO Initiative - Autonomous Networks
- ETSI ZSM - ONAP
  - PoC program
  - PoC on ONAP's Intent-based Cloud Leased Line Solution – Henry Yu
  - PoC on Control Loops
- ITU Focus Group on Autonomous Network (ITU-FG AN)
- GSMA - Operator Platform Group

- ITU-T Focus Group on Autonomous Networks was established by ITU-T Study Group 13 at its virtual meeting, 17 December 2020.
- The Focus Group will draft technical reports and specifications for autonomous networks, including exploratory evolution in future networks, real-time responsive experimentation, dynamic adaptation to future environments, technologies, and use cases.
- The Focus Group will also identify relevant gaps in the standardization of autonomous networks.

The primary objective of the Focus Group is to provide an open platform to perform pre-standards activities related to this topic and leverage the technologies of others where appropriate.



# Realization of ONAP/O-RAN Autonomous Networks Use Cases: ONAP 5G SON Use Case Perspective

Presented by:

N.K. Shankaranarayanan, STL (nk.shankar@stl.tech)

Krishna Moorthy, Wipro (krishna.moorthy6@wipro.com)

ITU-T Focus Group on Autonomous Networks 5<sup>th</sup> Virtual Meeting

Nov 3, 2021

ONAP 5G SON Use Case Contributing Companies:

STL, Wipro, AT&T, IBM, highstreet technologies, Ericsson, Nokia, Pantheon,

Reliance Jio, Rutgers University Winlab, Tech Mahindra, Verizon

# Introduction

- ONAP (Open Network Automation Platform) provides an open-source based architecture and platform which can be used to implement autonomous networking concepts
- ONAP 5G Use Cases (e.g., SON, Network Slicing) have demonstrated Proof of Concept (PoC) implementations which provide building blocks for network automation
  - Implementations are based on contributions to ONAP open source
- ONAP 5G Use Cases are designed to be have maximum alignment with O-RAN Alliance specifications for disaggregated open mobile networks
  - Ongoing work on harmonizing ONAP and O-RAN

# Talk Outline

- ONAP 5G SON Use Case – PCI and centralized ANR (~7)
- ONAP Control Loop for Network Automation with ML (~15)
  - Demo
- Model-driven architecture – interfaces, data models (~3)
- Harmonizing ONAP and O-RAN for end-to-end use case implementations (~10)
- Conclusion (~5)
- Q&A

# ONAP-based SON: O-RAN O1 focus (Rel.3 – Rel.9)

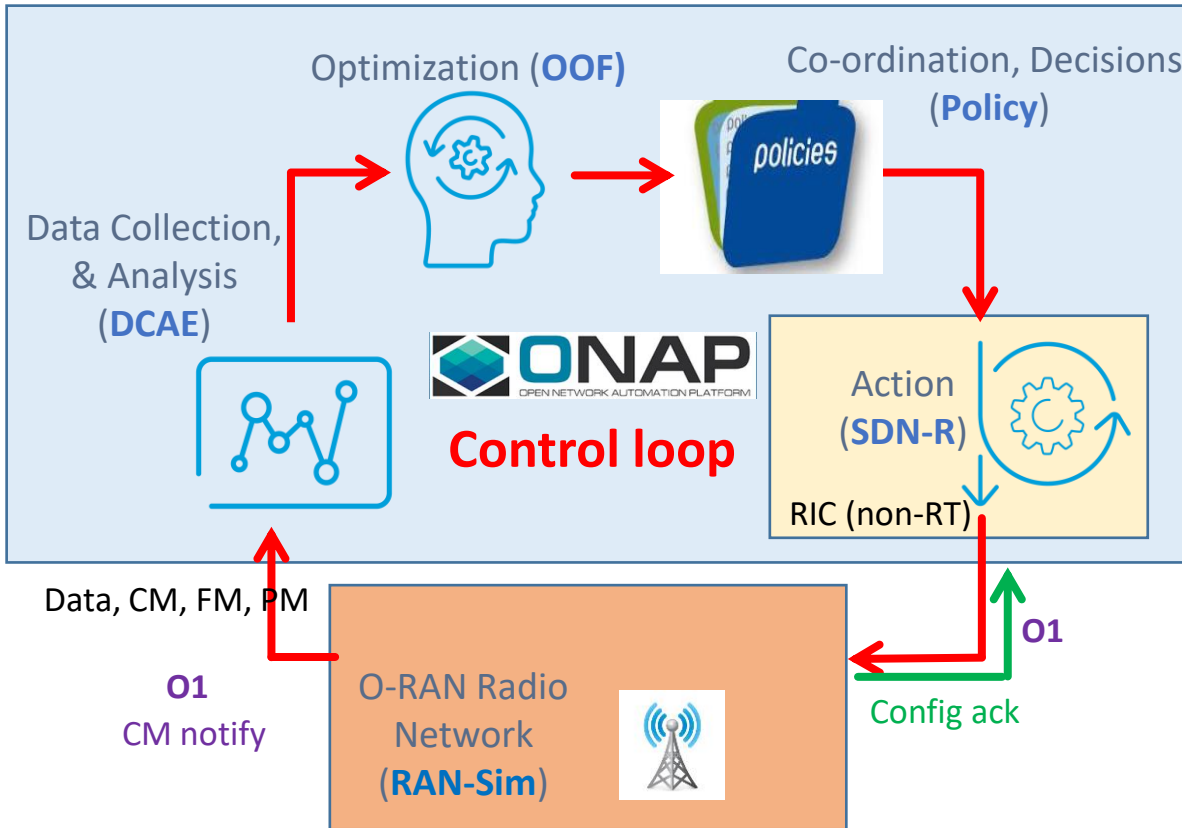

- SON  $\Leftrightarrow$  Control Loop (CL)
- ONAP: Open-source platform, with basic open-source code
- Companies can use framework to add proprietary SON solutions, including optimization algorithms, etc.

- OOF-SON use case has built a foundation for ONAP/O-RAN integration
- Radio network uses common netconf/yang model

## Data flows

- SDN-R to RAN: netconf-based configuration
- RAN to DCAE: VES format for FM alarms, PM KPI, CM Notification

- TM Forum Autonomous Networks
  - Intent Driven Management
  - TM Forum Multi-SDO Initiative - Autonomous Networks
- ETSI ZSM - ONAP
  - PoC program
  - PoC on ONAP's Intent-based Cloud Leased Line Solution – Henry Yu
  - PoC on Control Loops
- ITU Focus Group on Autonomous Network (ITU-FG AN)
- GSMA - Operator Platform Group



# GSMA - Operator Platform Group

- The Operator Platform Group is open to the wider edge-ecosystem and beyond brings together operators, platform developers, edge cloud providers, Standards Developing Organisations (SDOs), Open Source Projects, industry for and market participants.
- The Operator Platform defines a common platform exposing operator services/capabilities to customers/developers in the 5G-era in a connect once, connect to many models. The first phase of the platform focuses on Edge which will be expanded in future phases with other capabilities such as connectivity, slicing and IPComms.
- The Operator Platform Group is made up of over 40 of the world's leading operators and over 25 key ecosystem partners and is focused on developing requirements to deliver a common solution to the ecosystem. The OPG meet weekly to work on requirements and bringing the Operator Platform to market.

# Operator Platform Telco Edge Requirements

GSM Association  
Official Document OPG.02 - Operator Platform Telco Edge Requirements

Non-confidential



**Operator Platform Telco Edge Requirements**

**Version 1.0**

**29 June 2021**

[Link to document](#)

*This is a Non-binding Permanent Reference Document of the GSMA*

---

A close-up, low-angle shot of a golden wheat field. The wheat stalks are in sharp focus in the foreground, with a soft, warm glow from the sun in the background, creating a bokeh effect. The overall color palette is warm, dominated by yellows, oranges, and browns.

**OLF**

NETWORKING

---

LFN Developer & Testing Forum