



OPEN  
NETWORKING  
& EDGE  
SUMMIT

# ONAP and Cloud Native

Best of Both Worlds

Hosted By

 THE **LINUX** FOUNDATION |  **LF** NETWORKING |  **LF** EDGE

#ONESummit @twitter

# Our ONAP Cloud Native Journey



Prepared by Catherine Lefèvre (ONAP TSC Chair) & ONAP CNF Task Force

## Cloud Native Reference Architecture

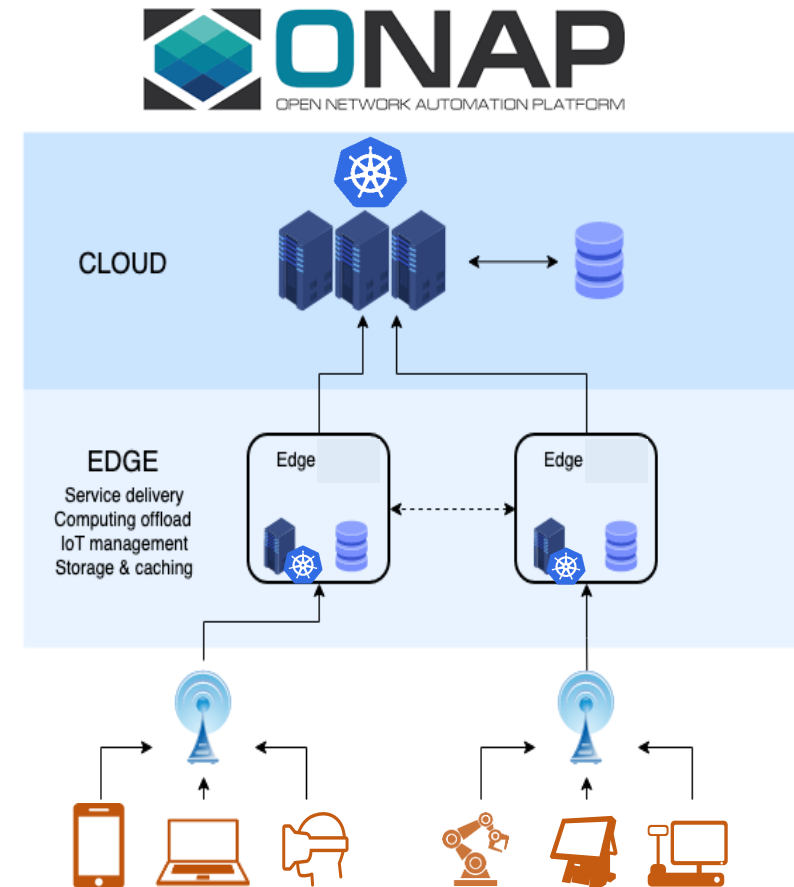
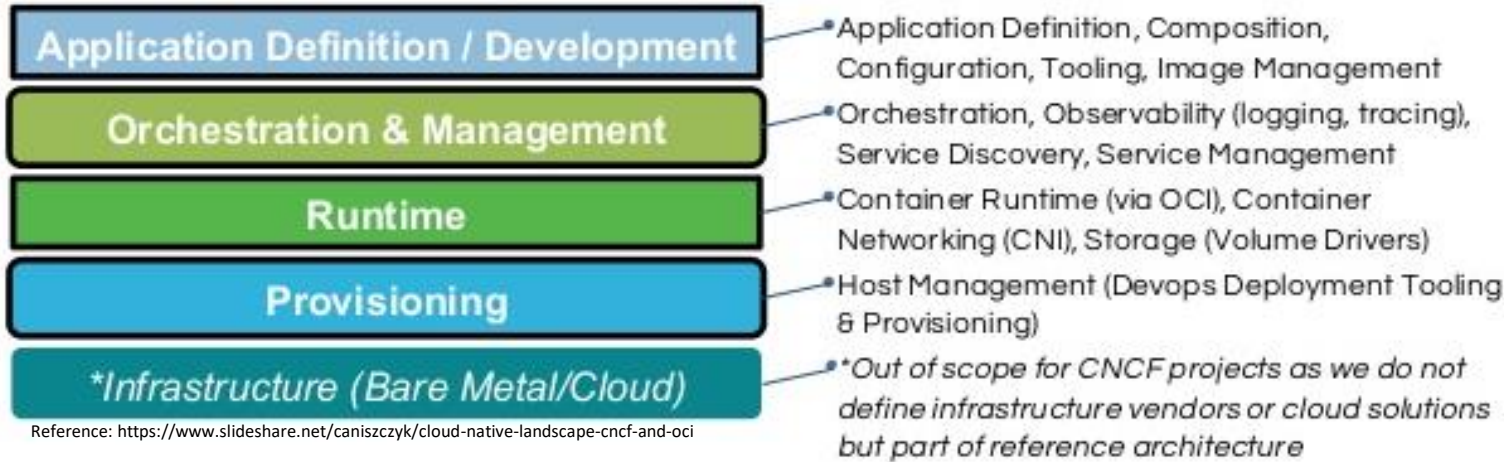

# Cloud Native Cornerstone – The Service Orchestration



Prepared by Srinivasa Addepalli (Intel), Timo Perala (Nokia)

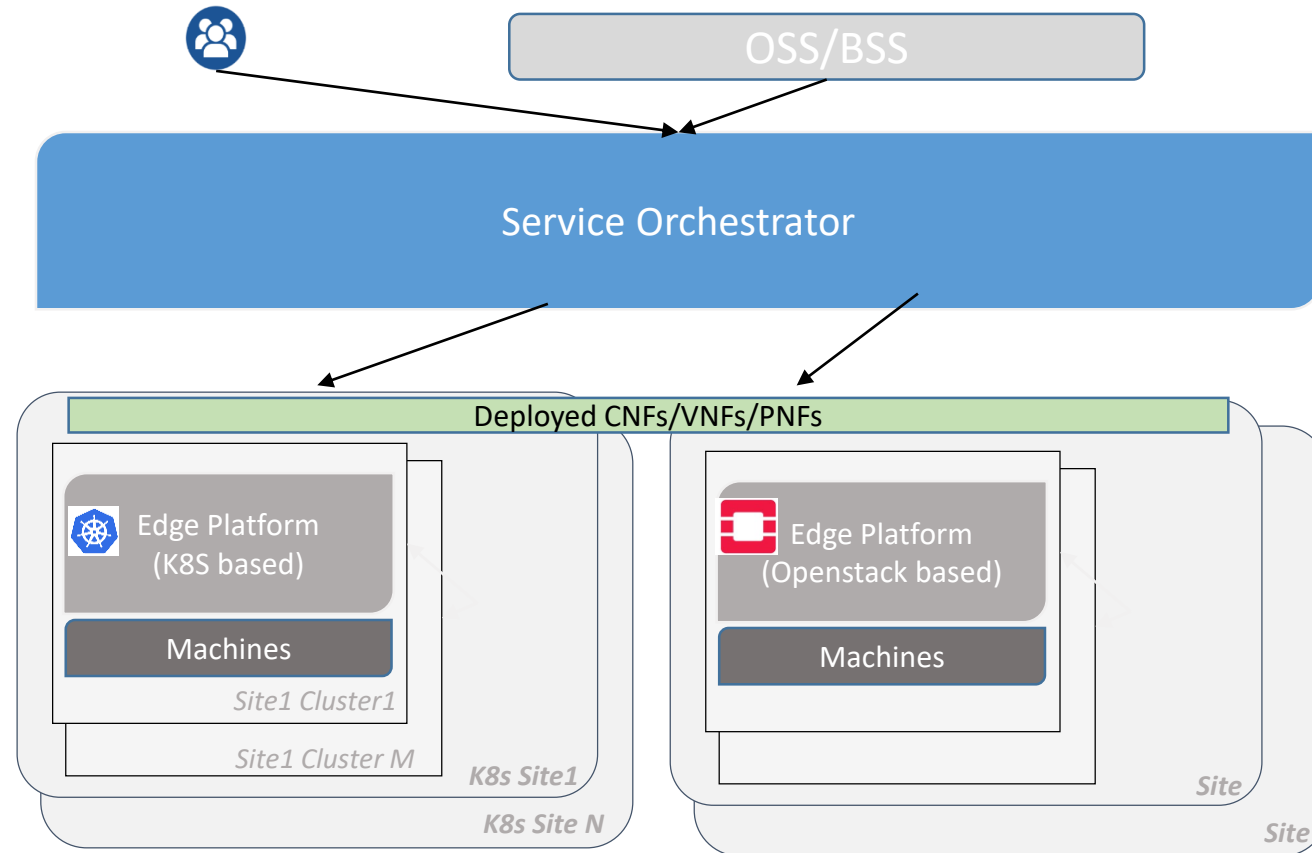

# Why Do You Need Service Orchestrator?



Prepared by Srinivasa Addepalli (Intel)

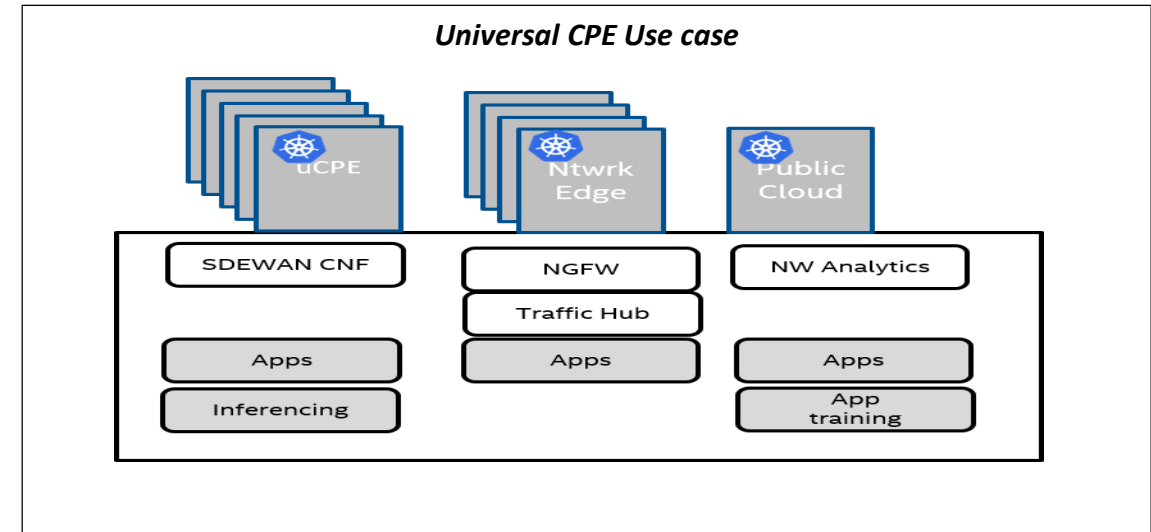
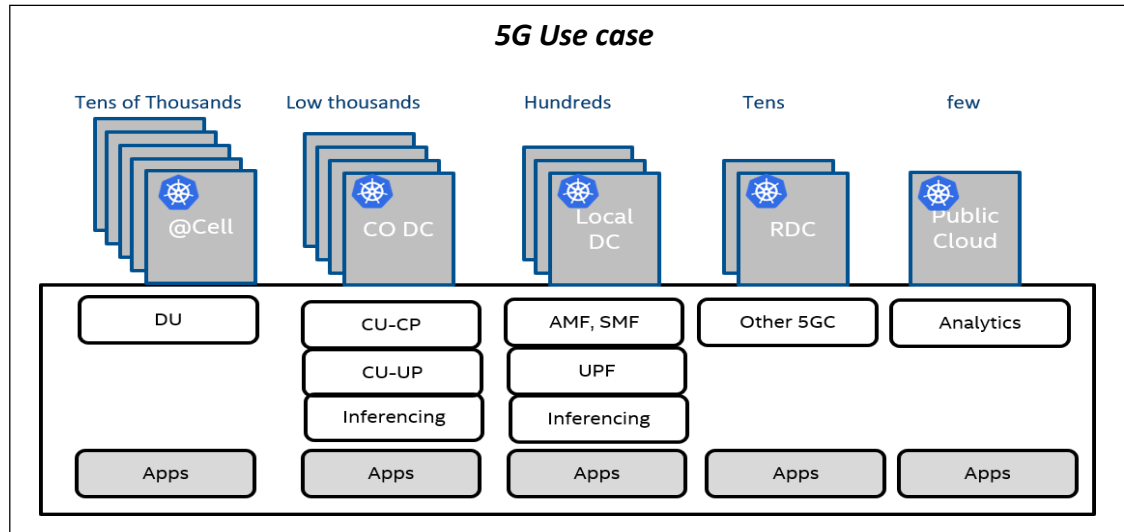

- *Large Number of sites*
- *Computing (Apps across sites) – MEC*
- *Multiple tenant applications along with operator CNFs.*
- *Workload types - VMs, VNFs, CNFs, CNAs and Functions (FaaS)*
- *Note: K8s is becoming choice of workload orchestrator in each cluster*

*Multi Edge/Cloud computing scale is similar (or even higher) to Hyper-scalers' scale  
Now Telcos, Enterprises, MSPs need @scale Orchestration and Automation solutions*

# What Is The Value Proposition of ONAP?



Prepared by Alla Goldner (AMDOCS), Srinivasa Addepalli (Intel)

ONAP itself uses Micro-service architecture & uses **Cloud Native principles**

ONAP Manages **Network-service & application LCM** across Multiple VIMs (Openstack, K8s)

ONAP **Design tools** support multiple descriptions (Helm, TOSCA, HEAT etc.)

ONAP **OOF (Optimization)** chooses the right locations to place workloads

ONAP **DCAE** collects telemetry from remote sites, analyzes them and generate any control loop actions (Scale, Heal)

ONAP supports standard models & APIs as per ETSI, TMF, MEF, 3GPP

ONAP enables **Day2 configuration** of Network functions via RESTful API, NetConf, K8s CRDs

ONAP **AAI** is the central repository that keeps site/network element inventory and network service status.

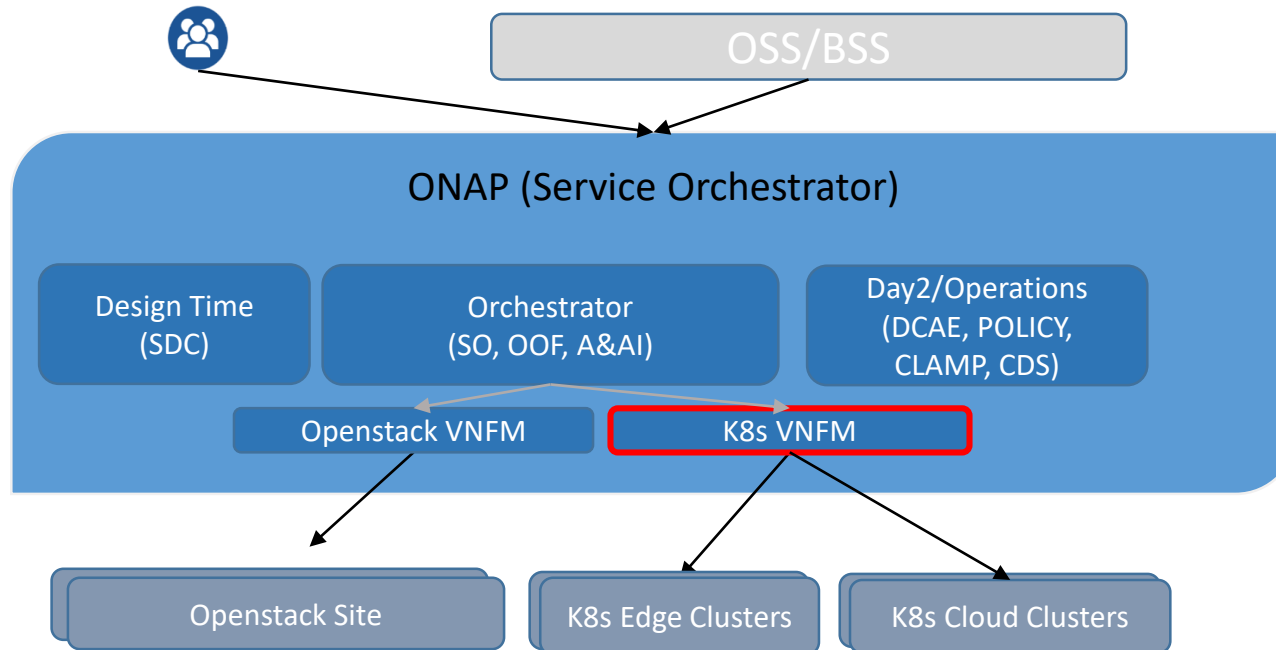

ONAP is a comprehensive service orchestrator

# Cross-Community CNF Landscape



Prepared by Olivier Smith (Matrixx), Ranny Haiby (Samsung)

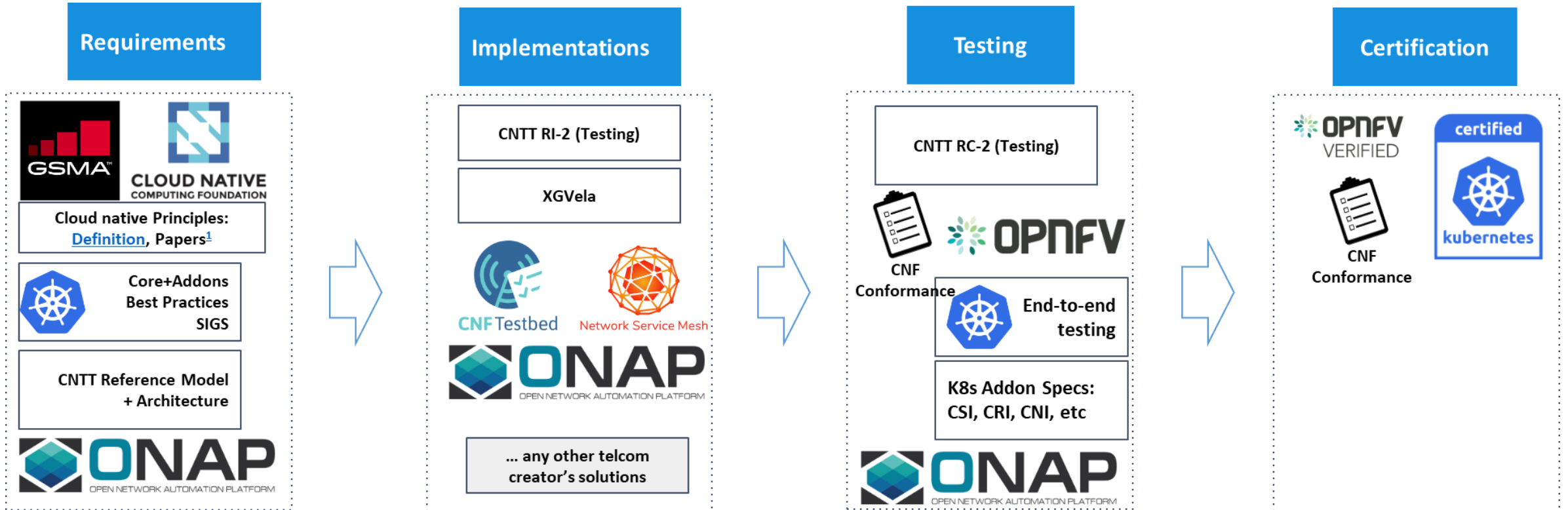

Requirements to create a reference platform w/workloads meeting the model (high-level requirements and features)

Communities can use the requirements as-is or with adjustments when implementing solutions for their end-users

Test cases can cover the requirements and be used for verification of the various implementations

LFN's certification and badging program. Will use the results of several upstream testing sources. Will use multiple sources for requirements.

Source: [https://docs.google.com/presentation/d/1rTUDaCKW96IUJYt-QckITmxwRUD1l8pFZe1xCqyK6yo/edit?ts=5f1f18cd#slide=id.g8ecce7b011\\_2\\_0](https://docs.google.com/presentation/d/1rTUDaCKW96IUJYt-QckITmxwRUD1l8pFZe1xCqyK6yo/edit?ts=5f1f18cd#slide=id.g8ecce7b011_2_0)

# ONAP For ETSI SDO (Conformance to ETSI Specifications)



Prepared by Byung-Woo Jun (Ericsson), Fred Oliveira (Verizon), Seshu Kumar (Huawei)

## NS/VNF/PNF Modeling and Packaging Conformance

- **SOL004** for VNF and PNF packages
- **SOL007** for NS package
- **SOL001** for describing VNF, PNF and NS models
- **SOL003 (IFA007)** for VNF Package Management
- **SOL005 (IFA 013)** for NS/PNF/VNF Package Management
- **SEC022** for ETSI Package and API security

## Lifecycle Management Conformance for

- **SDC** for SOL004 and SOL007 package onboarding, design and distribution
- **ONAP NFVO (VFC and SO NFVO) and External NFVO** for ETSI MANO SOL005-compliant NFVO functionalities.
- **SOL003 Adapter** for SOL003-compliant VNF LCM interfaces
- **SOL005 Adapter** for SOL005-compliant NS LCM interfaces
- **SOL002 Adapter** for SOL002-compliant VNF/VNFC LCM interfaces (currently on hold)
- **ETSI Catalog Manager** for ETSI SOL004/SOL007/SOL001 Runtime Package Management and Parsing for NS/VNF/PNF

## Ongoing CNF Modeling, Packaging and Orchestration Conformance

- **IFA 011 (VNF Descriptor and Packaging Specification)**
  - ONAP VNF/CNF package and models including Helm Charts & Container Images conform to IFA 011
- **IFA 040 (Service interfaces for OS Container Mgmt & Orch)**
  - ONAP conforms to the OS container NFV object model, CISM and CIR management, based on IFA 040
- **IFA 010 (NFV Mgmt & Orchestration Functional Reqs)**
  - ONAP NFVO and VNFM orchestration functions conform to IFA 010 requirements
- **IFA 005 (Or-Vi Interface and IM)**
  - ONAP NFVO and VIM interfaces conform to IFA 005 (Or-Vi)/OpenStack
- **IFA 006 (Vi-Vnfm Interface and IM)**
  - ONAP architecture conforms to IFA 006/OpenStack for the interfaces between VNFM and VIM

On top of the ONAP ETSI package onboarding and distribution mechanism, ONAP will support enhanced VNF/CNF models, Helm Charts, CIR and interactions with CISM and VIM for LCM

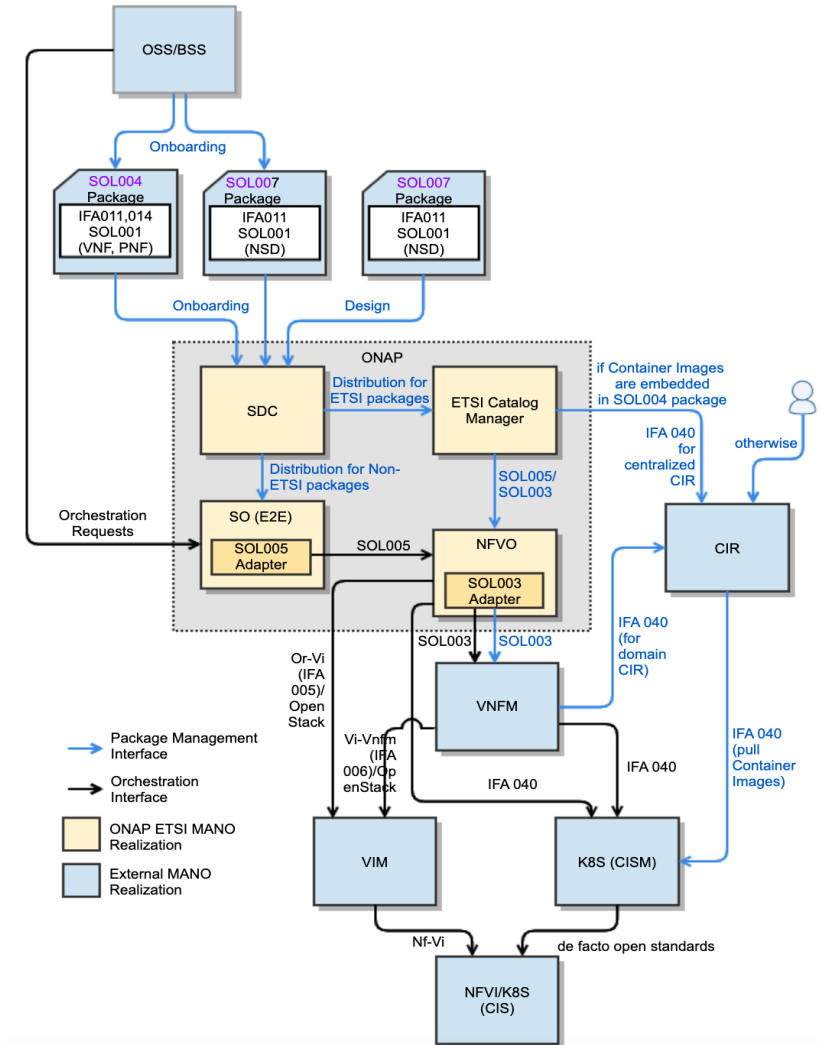



# ONAP CNF Evolution



Prepared by Seshu Kumar (Huawei), Lukasz Rajewski (Orange)



## PAST

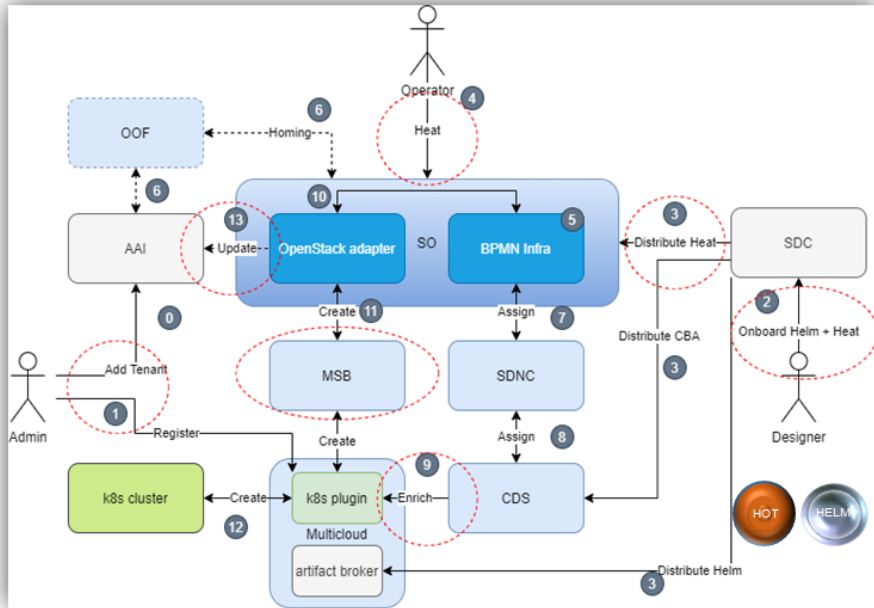

### Frankfurt

- Embedding the helm into the heat package distro
- Installation of Helm package into K8s cluster
- Basic helm enrichment through CDS



## PRESENT

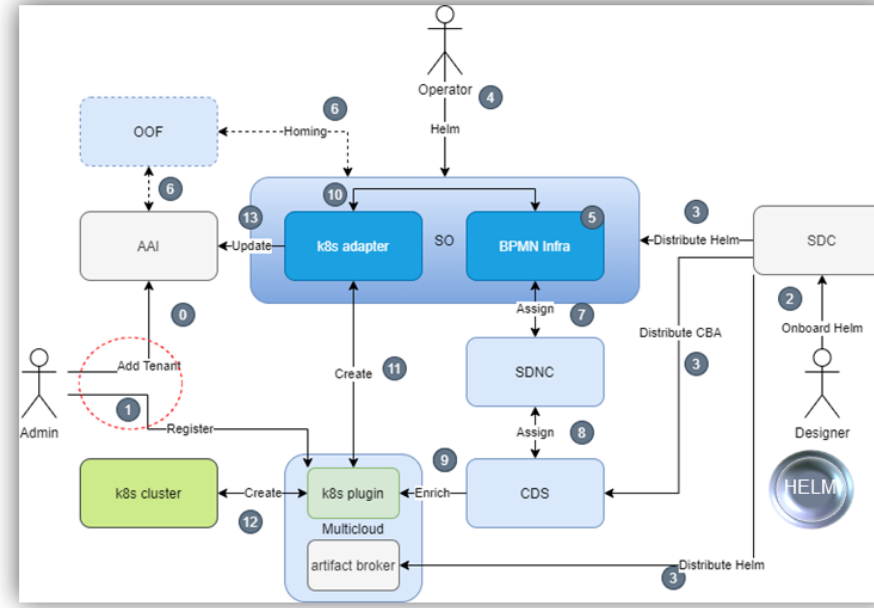

### What Guilín Will Bring

- Native Helm package support in SDC and SO
- Native Helm enrichment support in Controller Design Studio
- E2E CNF Orchestration chain in all SO components



## FUTURE



HEAT TOSCA      HEAT TOSCA HELM      HELM

### Beyond

- Extension in AAI CNF model
- Health Check and Monitoring of CNF resources
- CDS Native CNF Configuration
- Discovery of K8S cluster in ONAP
- Cross community Integration





# OPEN NETWORKING & EDGE SUMMIT

Hosted By

 THE **LINUX** FOUNDATION |  **LF** NETWORKING |  **LF** EDGE