

# Configuration & Persistency Service



- Release 8 (Honolulu) TSC Presentation  
Oct 01, 2020 version 11

 Zu Qiang (Ericsson)

 Michela Bevilacqua (Ericsson)

 Toine Siebelink (Ericsson)

 Tony Finnerty (Ericsson)

 Jacqueline Beaulac (Ericsson)

 Rishi Chail (Ericsson)

 Ciaran Johnston (Ericsson)

 Pawel Slowikowski (Samsung)

 Swami N (Wipro)

 Bruno Sakoto (Bell Canada)

 Fred Feisullin (Verizon Wireless)

 Ben Cheung (Nokia)

 Marge Hillis (Nokia)

 Shankar N K (AT&T)

 Ted Johnson (AT&T)

 Claudio Gasparini

# R8 TSC Project Proposal Presentation

TIME	Oct 01, 2020 TSC Agenda
5 min	<b>Context &amp; Overview of C&amp;PS &amp; Agenda</b> – Introduction to C&PS, Project Context.
5 min	<b>Model Driven C&amp;PS Proof of Concept (PoC)</b> – Overview of the Model-Driven C&PS PoC for R7.
5 min	<b>Project Proposal &amp; Progress from last presentation</b> – Project proposal (teaser), Project Roadmap, TSC Vote
5 min	<b>Questions &amp; Answers</b> – Q&A

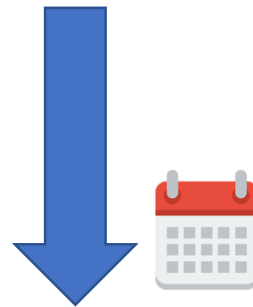

TIME	Q&A Session Post-Session
-	<b>Follow-up questions</b> – Follow-up meetings at C&PS Team Call (Fridays)

# Overview of Configuration & Persistency Service



**Context**



**Architecture S/C**



**Overview**

# Context for C&PS



TOPIC	PROBLEM	SOLUTION
<b>Heterogeneous Data Sources</b>	Reconciling Multiple domains, multiple vendors, multiple functions and multiple versions	Model Driven Persistence
<b>Shared Data Access</b>	Expensive IO operations that should be shared rather than duplicated	Share Data access through model ownership
<b>Model Handling</b>	Because of the heterogeneous data sources need streamlined approach to support models without having platform life cycle events.	Model Driven Persistence
<b>A&amp;AI Scope Creep</b>	A&AI storing non-inventory information resulting in mismatch of A&AI access	Storing Network Element data in C&PS instead of A&AI

# Configuration & Persistency Service (C&PS)

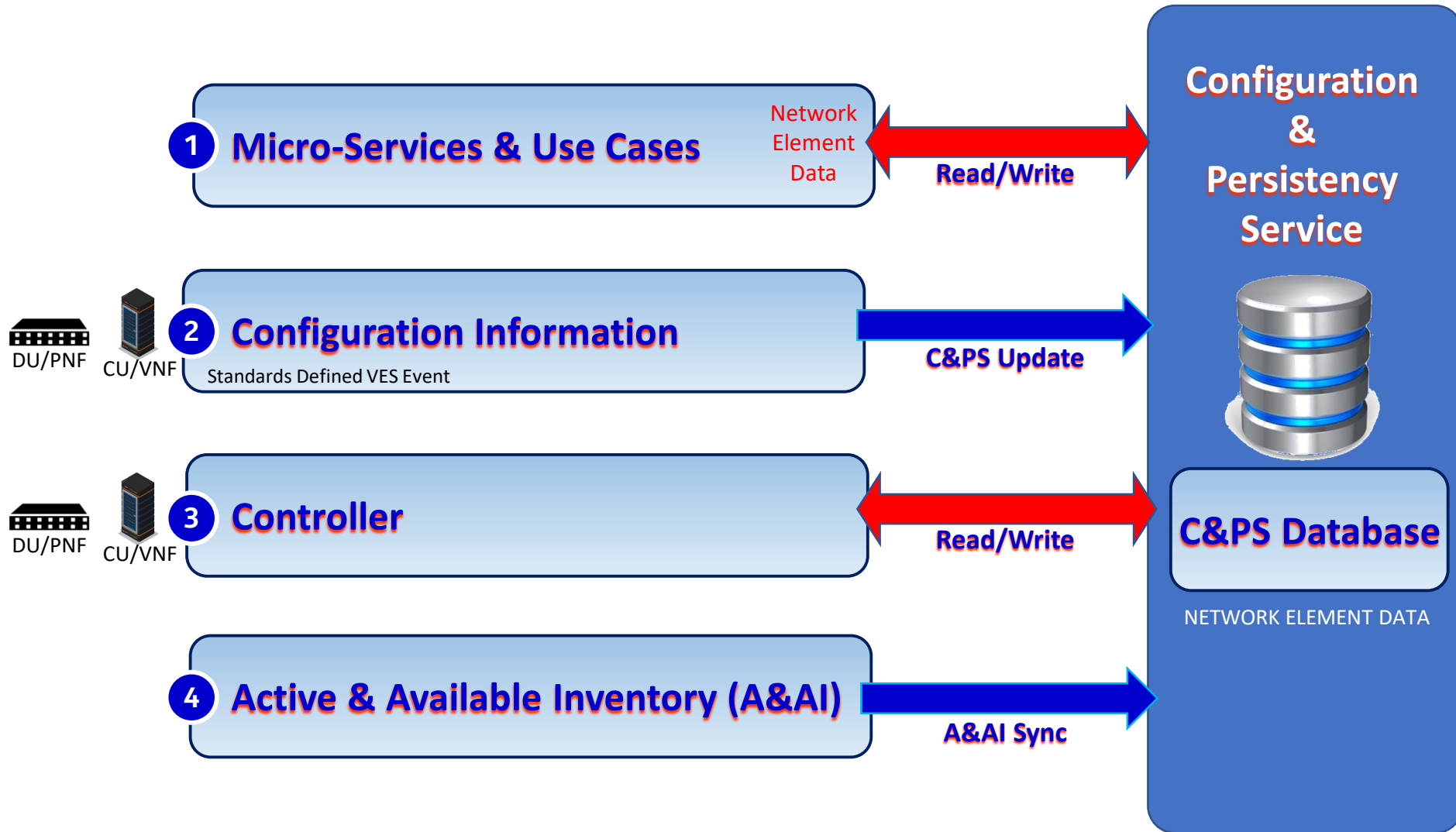

# Configuration & Persistency Service (C&PS)

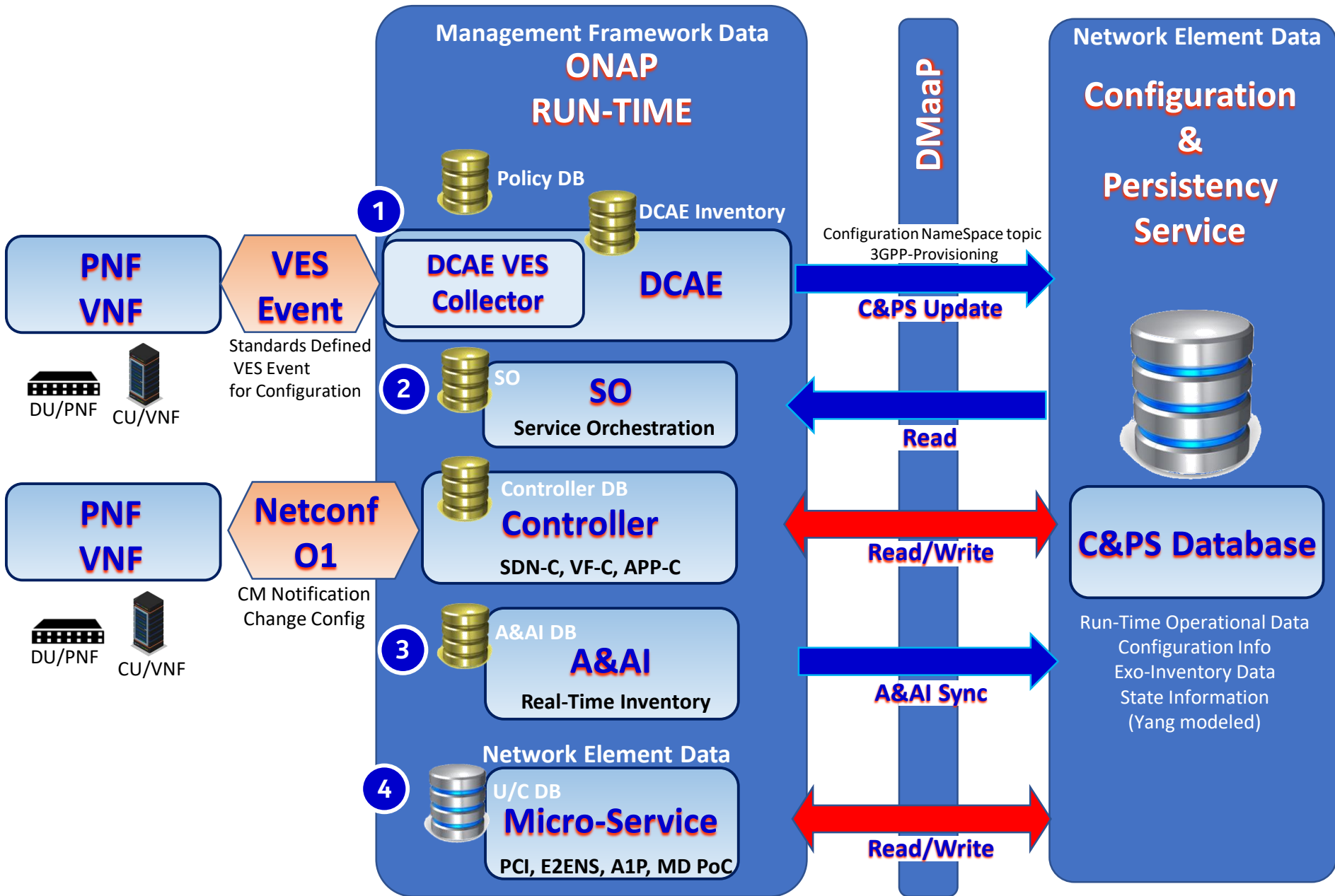

# Configuration & Persistency Service (C&PS)

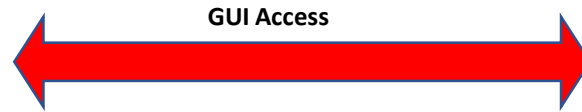
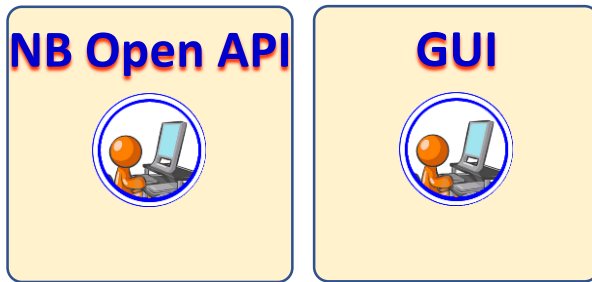
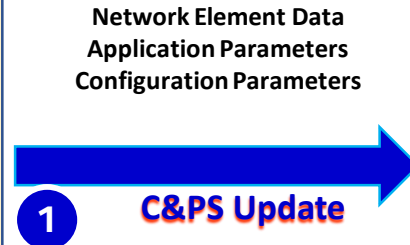
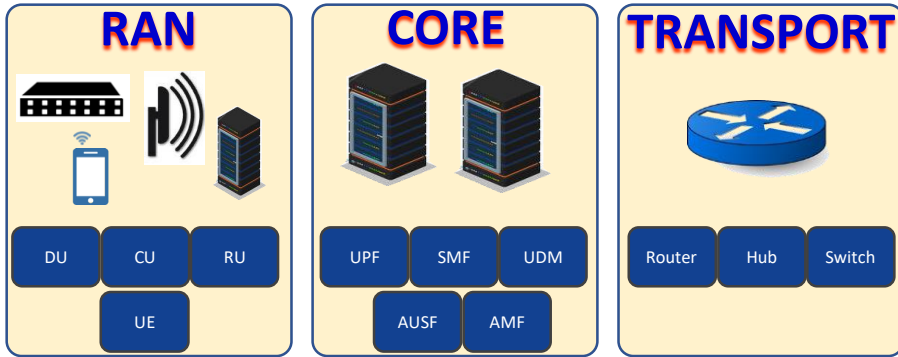

Network Element Data

**Configuration & Persistency Service**



**C&PS Database**

Run-Time Operational Data  
Configuration Info  
Exo-Inventory Data  
State Information

## ONAP Micro-services, POCs & Use Cases

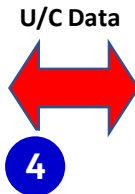
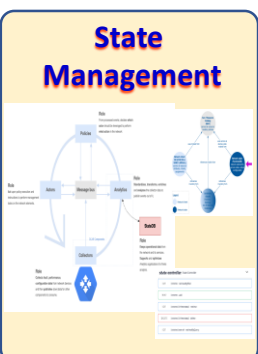
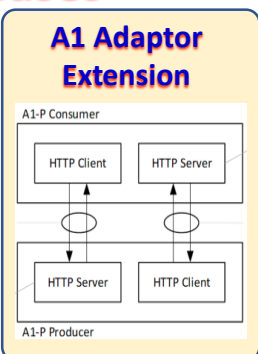
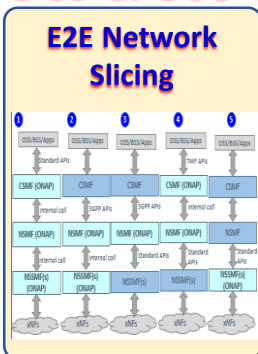
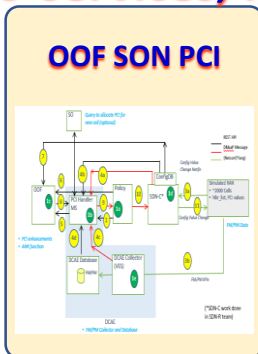
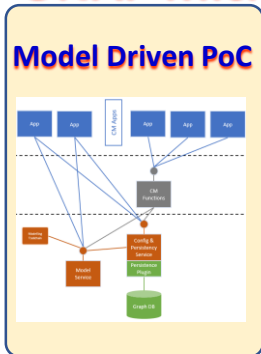



OSS / BSS / Other

Legend **Design** Orchestration & Management Operations

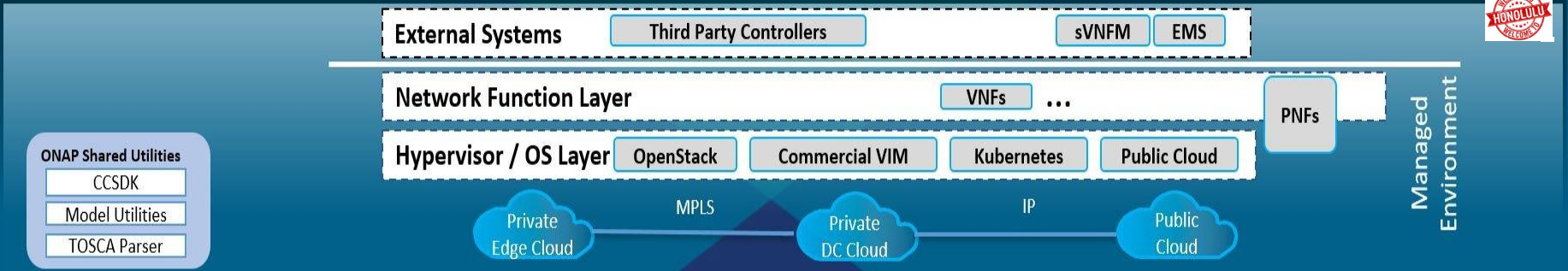
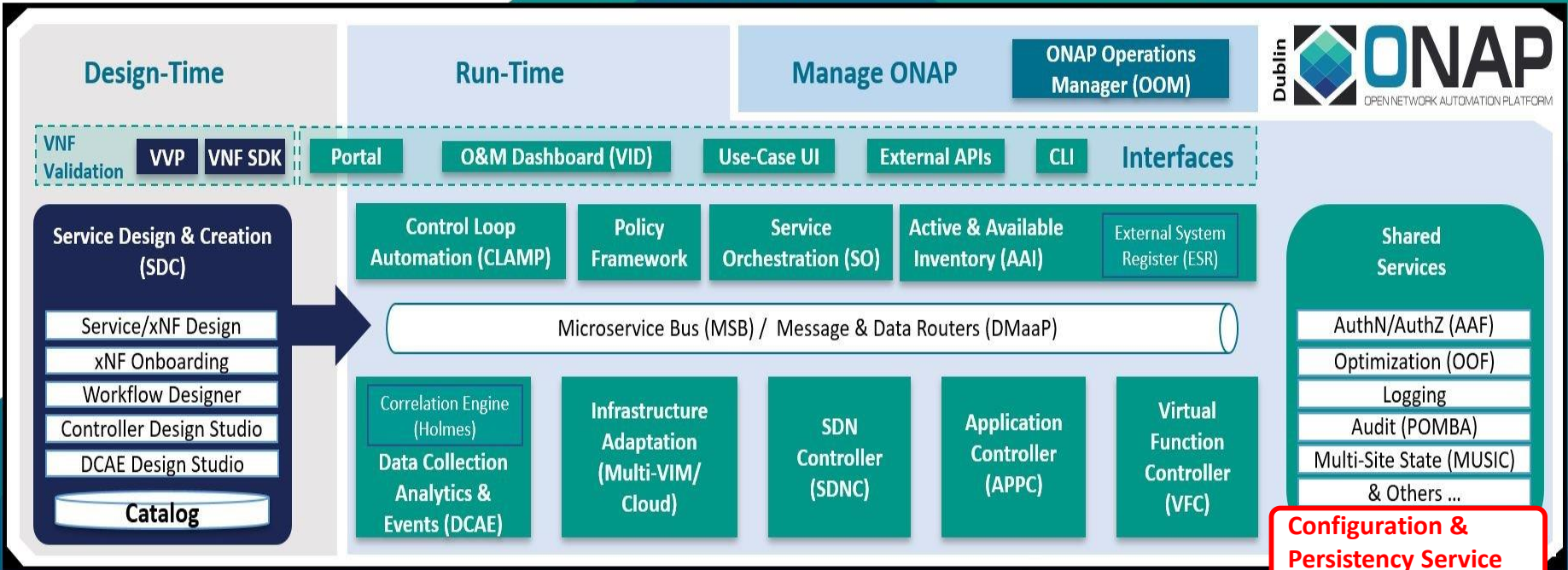



# R7 – Model Driven Configuration & Persistency Service Proof of Concept



**Proof of Concept**

# R7 Model Driven C&PS PoC



Use case	Component	Work required
----------	-----------	---------------

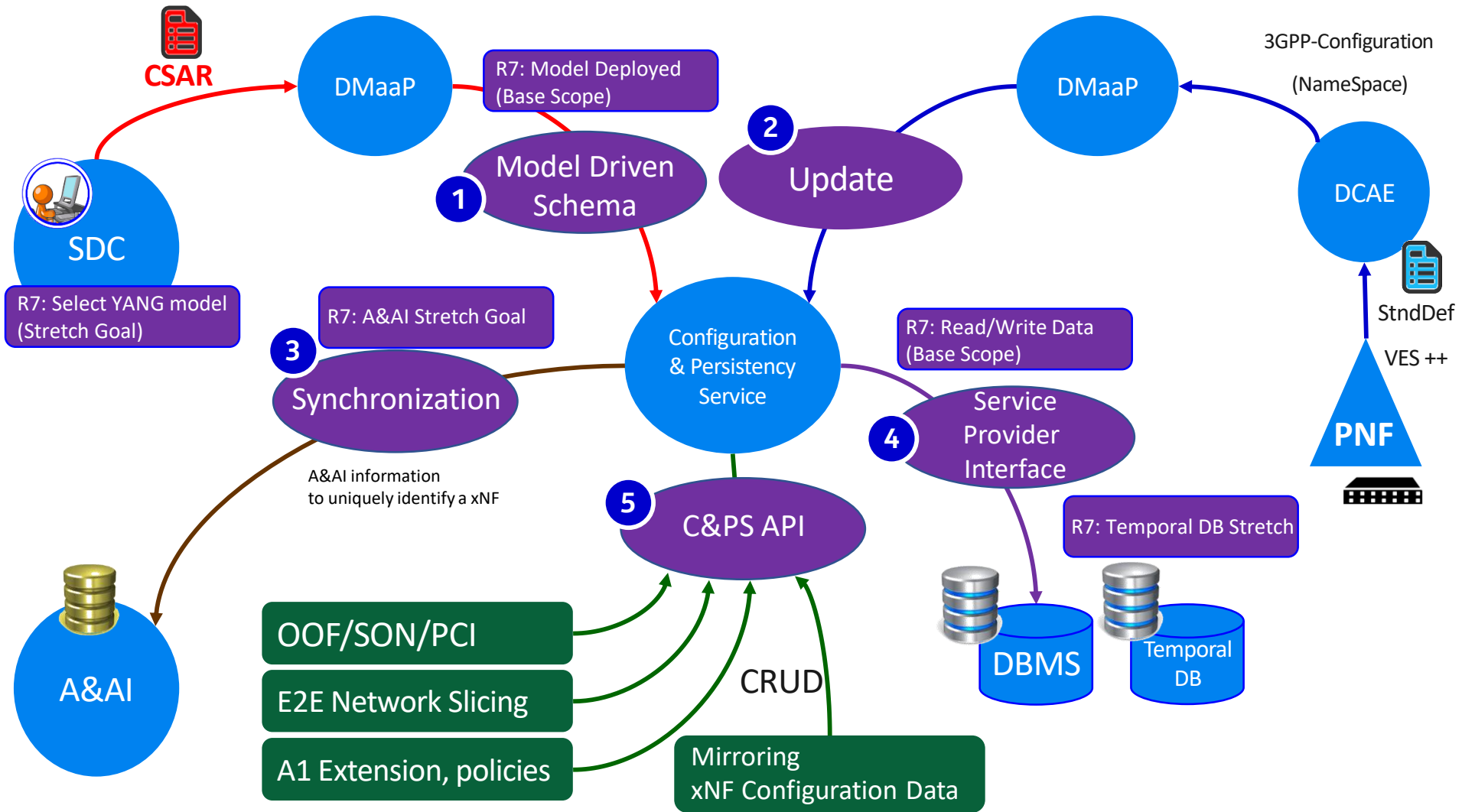

# R7 Model Driven C&PS PoC Lessons Learned



TOPIC	PoC RESULTS
<b>SEED CODE</b>	Seed Code to serve as a basis for C&PS has been developed
<b>PROOF POINTS</b>	<ol style="list-style-type: none"><li>1. Create/read CRUD operations using YANG fragments using a simple schema or schema-less repository</li><li>2. Deploy &amp; upgrade YANG model fragments at run-time</li><li>3. Validate based on YANG Constraints</li><li>4. Provide architecture vision and roadmap for a target architecture.</li></ol>
<b>ARCHITECTURE AGREEMENTS</b>	Resolve key architectural Issues necessary for C&PS as a stand-alone project
<b>C&amp;PS CORE FUNCTIONALITY</b>	Can soon demonstrate some key C&PS operations
<b>PERFORMANCE LIMITS</b>	Ascertain a sense of Performance and Capacity boundaries

# R7 Model Driven C&PS PoC Lessons Learned



- Base : N/A (new code)  
Main dependency : ODL Yang Tools 5.x (probably)  
<https://javadoc.io/doc/org.opendaylight.yangtools>

- Design and Architecture discussions ongoing  
<https://wiki.onap.org/display/DW/Issues+decisions+and+assumptions>

8	1	MEDIUM	Existing Yang Parser	Is there an existing Yang Parser in ONAP an/or OpenDayLight that can be used for C&PS	No	
9	N/A	AGREED	Location of PoC Code	Dan Timony suggested to use an existing CCSDK repo, he mentioned ccsdk/features. As long as the PoC remains completely independent and doesn't affect delivery of existing artifacts in the same repo.	--	ccsdk/features, see <a href="https://gerrit.onap.org/r/c/ccsdk/features/+110385">https://gerrit.onap.org/r/c/ccsdk/features/+110385</a> (awaiting approval)
10	N/A	AGREED	Common information model, Data lake and Access control	How will the CPS help with managing coupling between ONAP components that make use of data lake and common information model	--	We will start with Architectural Approach A in the PoC with the aim of fully supporting Architectural Approach C.  I.e. access to the data lake will be conditional on permission granted by the data owner. In the PoC we will not implement the permission granting mechanism
11	4,5	MEDIUM	Transactional behavior	It needs to be clear to users the level of atomic operations supported by the CPS	Yes	

# C&PS Roadmap



Roadmap





# C&PS Roadmap & R6-R8 Plan

## Configuration & Persistency Service (CPS) Roadmap –

R6 Frankfurt

R7 Guilin



R8 Honolulu



### C&PS 1.0

#### R6 C&PS

- CC-SDK/SDN-C solution
- Evolution of “ConfigDB”

#### Supporting R6 Use Cases

- SON/OOF/PCI U/C

June 5, 2020

### C&PS 1.1

#### R6 C&PS Extensions

- Evolution of CC-SDK/SDN-C solution REQ322

#### Supporting R7 Use Cases

- SON/OOF/PCI U/C
- 5G E2E Network Slicing

#### Model-Driven PoC

- Seed implementation
- Write NE Data
- Read NE Data
- Access Control
- Info-Modeling design

#### State Management PoC

- State Management PoC (BellCA) self-contained

December 2020

### C&PS 2.0

#### R8 C&PS stand-alone project proposal

- Deprecate C&PS 1.0 & 1.1
- Project proposals TSC/Architecture S/C
- Setup Project Repo
- Full Info-Model

#### CPS FUNCTIONALITY:

- Data Recovery
- Model Adaption (Dynamic Schema)

June 2021

Legend:

RED text is CC-SDK/SDN-C solution

BLUE text is the PoC & stand-alone project

# C&PS Roadmap & R8-R10 Plan



## Configuration & Persistency Service (CPS) Roadmap –

R8 Honolulu



R9 Istanbul



R10 Kyoto



### **C&PS 2.0**

#### **R8 C&PS stand-alone project proposal**

- Deprecate C&PS 1.0 & 1.1
- Project proposals TSC/Architecture S/C
- Setup Project Repo

#### **CPS FUNCTIONALITY:**

- Data Recovery
- Model Adaption (Dynamic Schema)

Legend:

RED text is CC-SDK/SDN-C solution

BLUE text is the PoC & stand-alone project

June 2021

Rx (future) development

#### **CPS FUNCTIONALITY:**

- Data Auditing Model driven
- Topology Traversal
- Data Syncing

December, 2020

Rx (future) development

#### **CPS FUNCTIONALITY:**

- Data Auditing Rules Driven
- Data History
- Roll-Back
- Database Backup
- Performance Optimization (Scaling)

June 2021

# Questions





## Notes from Oct 1, 2020 TSC Meeting / Q&A

### Identify a PTL?

Catherine – Naming a PTL

Identify Committers / Vote among Committers. Commitment to the project & staffing.

### What kind of DB will be used? (Eric Debeau)

Designed with a SPI which allows for other DBs to be integrated, such as a TSDB. Currently the C&PS PoC is using MariaDB because it was pervasive in ONAP. Postgres is a possibility as well. The SPI reference implementation, MariaDB would be sufficient for that. As the PoC/project progresses, we may eventually swap it out for another relational database. E.g. different technologies have different capabilities JSON string vs JSON binary storage. Those characteristics may influence the final decision.

### Testing & validation of integration a DBMS?

Thus, the C&PS is looking at a DBMS solution that already exists. The final development of C&PS in R8 will investigate this. This will also depend on the Use Case team's needs. There isn't any technical hurdle to using a shared DBMS solution that already exists in ONAP.

### There are already DBs in ONAP, can they be reused?

Currently the C&PS project is using a dedicated one, and the team is looking at how to get the schema into that. Reutilizing an existing DBMS will depend on how that interface is exposed. This will be investigated in R8.

### Issue a TSC VOTE!

Send email to ONAP-TSC Vote, Slides, Recording, & Deadline Oct 12 for final vote.

Based on material, recording, information presented at TSC does the TSC approve

The C&PS project be an independent project. Tool chain. 55% test coverage.

+1 Yes/ -1 No (why?) / 0 no opinion

# APPENDIX



# Dependencies vs Scope

## DEPENDENCIES – need to operate

SDC Yang Model (to load schema)  
ability to process & translate yang models into schemas  
AAF (intra-ONAP security)  
Database implementation for Data Persistency  
(for example MariaDB)

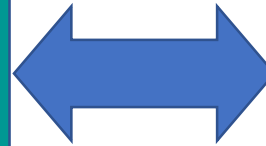

## DEPENDENCIES – value added

DMaaP (some use cases to work / indirect dependency)

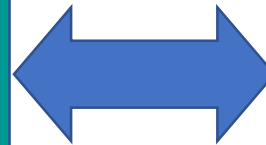

## SCOPE





**C&PS**  
**Database**



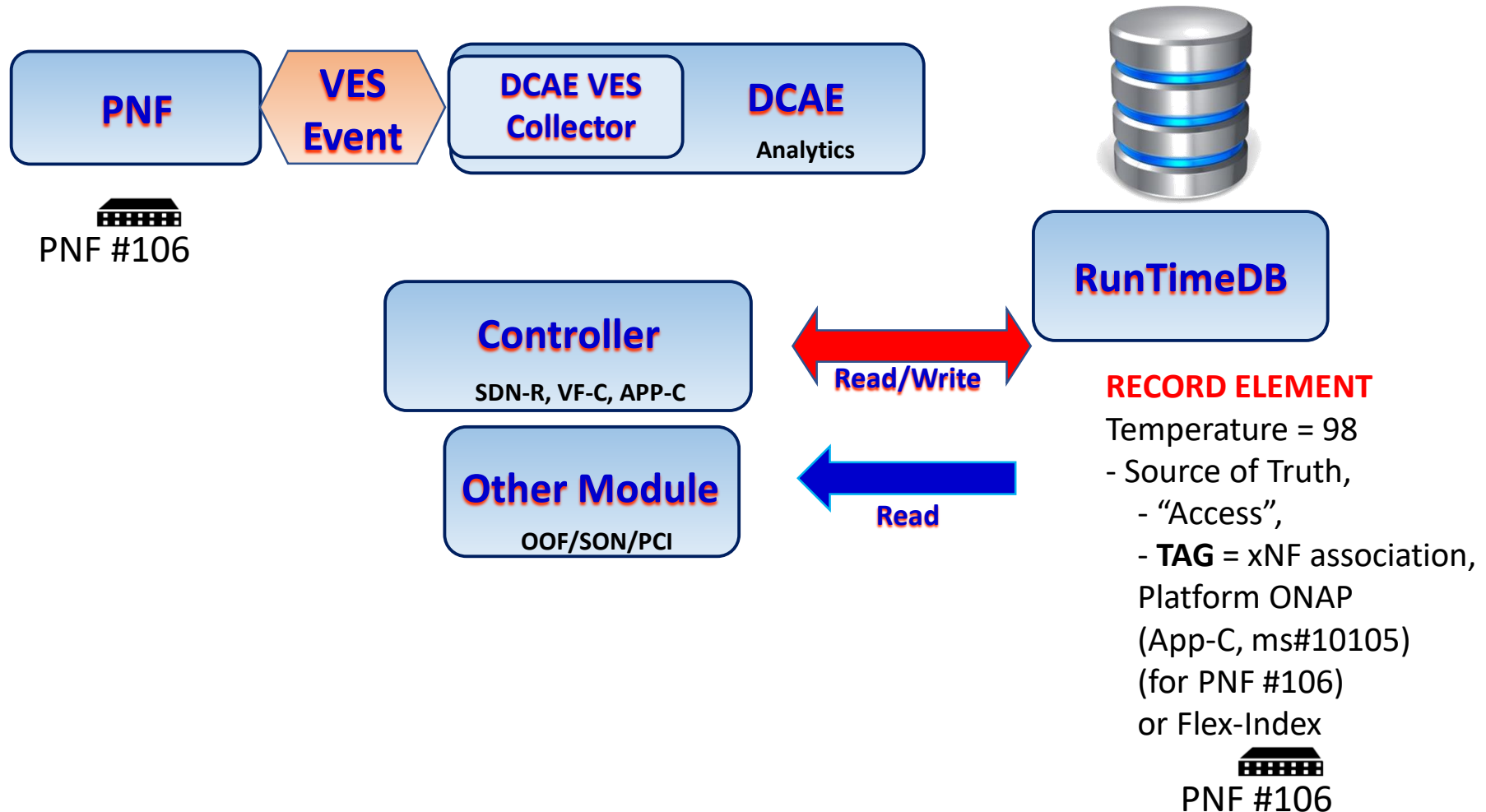





RECEIVE INFORMATION  
WRITE INFORMATION  
PUBLISH CHANGES  
REFERENTIAL INTEGRITY  
INGEST PACKAGES  
LOGICAL OBJECTS  
ASSOCIATIONS  
CARDINALITY RULES  
LINKING RESTRICTIONS  
SYNCHRONIZATION  
DATA INTEGRITY & RECOVERY

# Config & Persist Service (Run-Time View)



-  PNF #101
-  PNF #102
-  PNF #103
-  PNF #104



-  PNF #101 
-  PNF #102 
-  PNF #103 
-  PNF #104 



-  PNF #101 
-  PNF #102 
-  PNF #103 
-  PNF #104 

A&I correlated/Index to RunTimeDB  
Publish changes in A&I, notification on DMaaP

Indices into Config & Persist Service may also use Flex-Index (such as CellID)

# C&PS Database (Run-Time View)

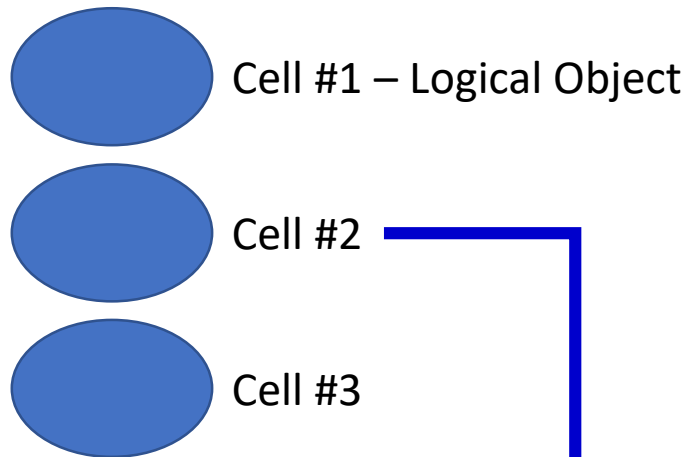

## RECORD ELEMENT INDEX = PNF #106

Parameter #1  
Parameter #2  
Parameter #3  
State Info X.733

### Associations

{ Logical Object #111 Cell #2 }

### Cardinality Rules

### Linking Restrictions

## RECORD ELEMENT INDEX = Logical Object #111

Parameter #1  
Parameter #2  
Parameter #3  
State Info

### Associations

{ PNF #106 }

### Cardinality Rules

### Linking Restrictions

## RECORD ELEMENT INDEX = PNF #106

Parameter #1  
Parameter #2  
Parameter #3  
Logical object, Cell #1  
Cell Parameter #1  
Cell Parameter #2  
Cell Parameter #3

# C&PS Information Model Design R7

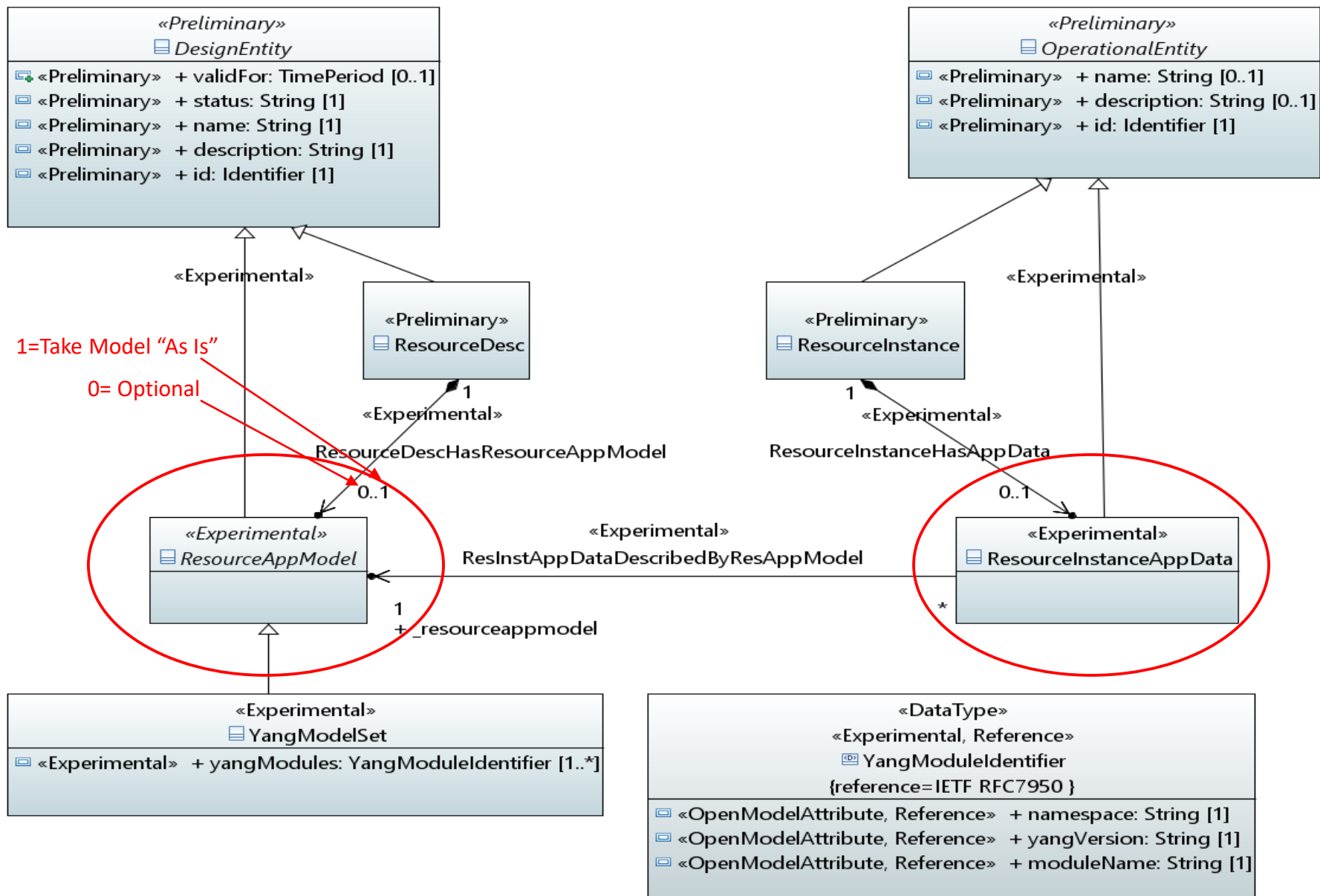

# C&PS Information Model Design R8

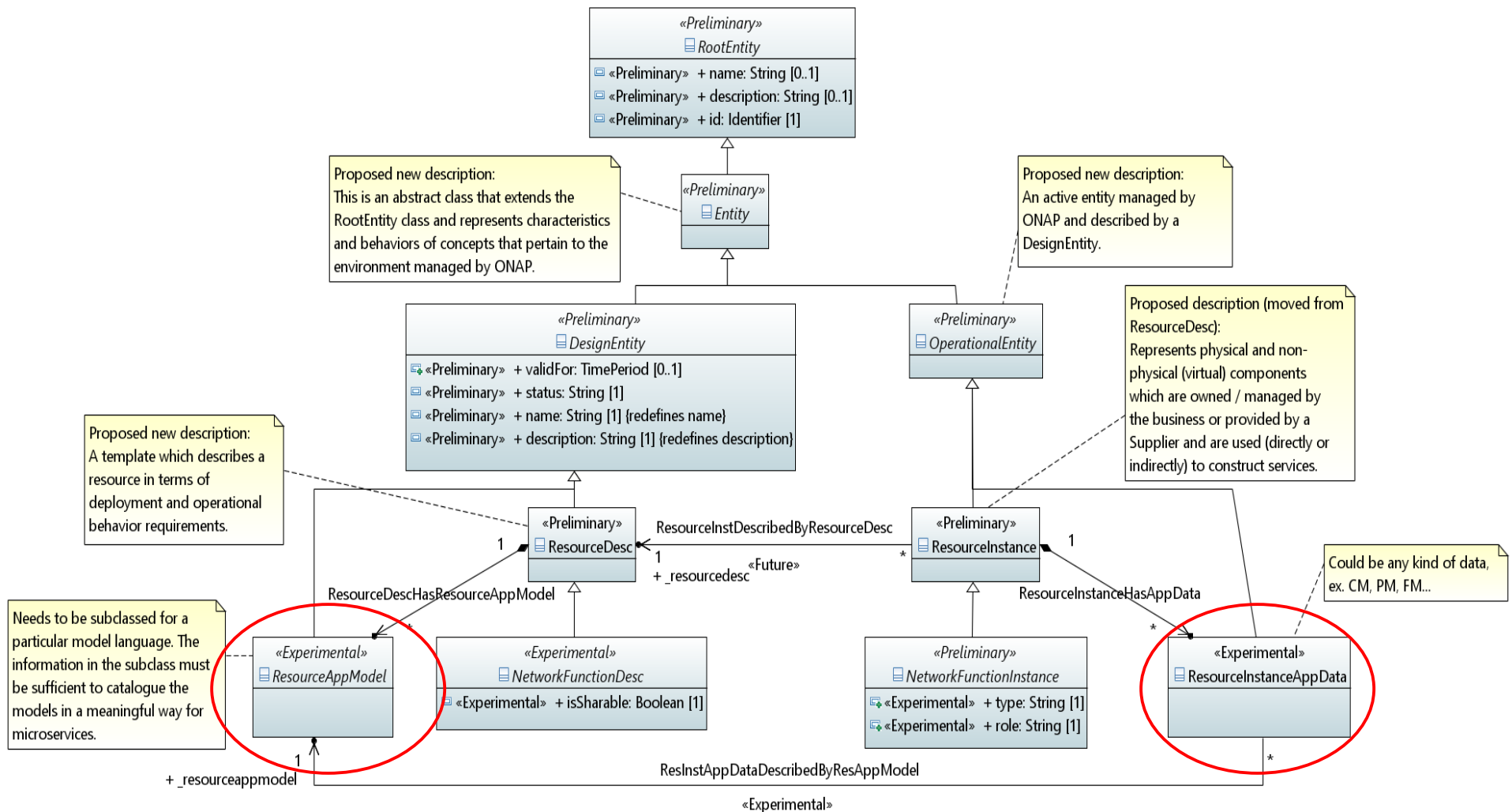



# C&PS Time Series Management

## Streaming Database

Analyze large volumes of continually arriving data, keep little state.

E.g., count the number of packets transmitted over an interface, by 1 minute intervals

Storm, Flink

## Time Series Database

Store KPIs : periodic measurements of an entity, emphasis on analytics

E.g. find peak transmission periods of an interface.

InfluxDB, TSDB

## Temporal Database

Store current and past conditions of an entity.

E.g., Keep track of an interface state

Postgres, MariaDB

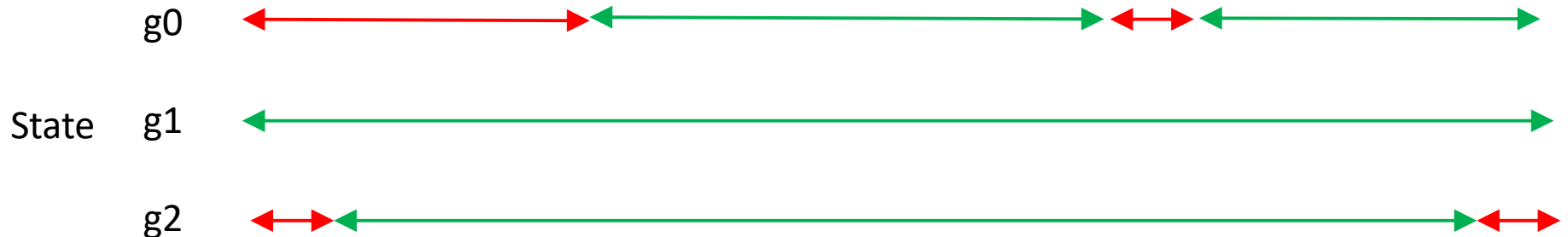

# A&AI vs C&PS

**Concepts** – A&AI conceptually stores Real-time inventory view of connected and “topology” of xNFs that ONAP sees. C&PS stores Network Element Data. A&AI and C&PS overlaps because they both need to know about Network Element objects so that can managed & orchestrated.

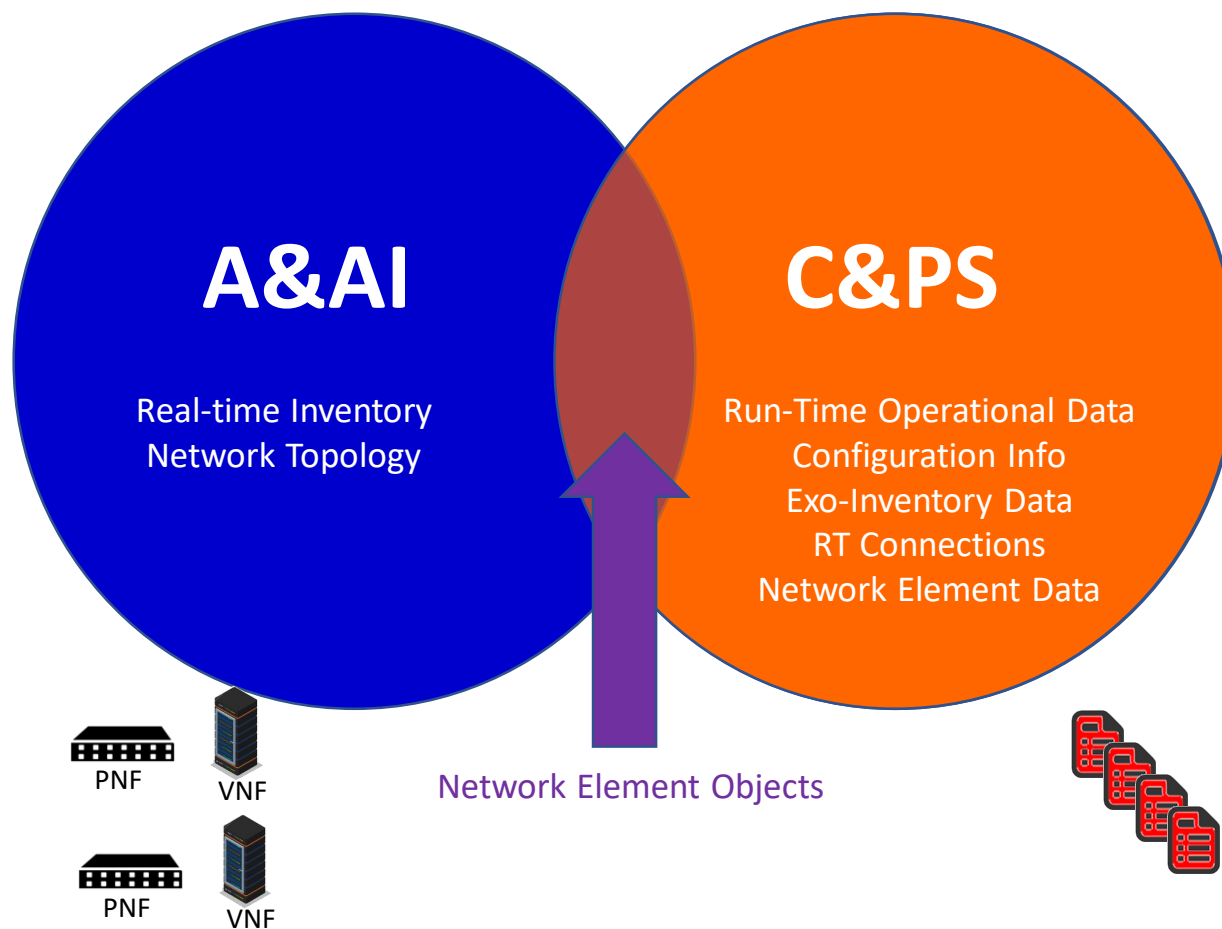

# Use Cases & Proof of Concepts



**Use Cases**



**Proof of Concept**

# C&PS Use Cases and Proof of Concepts in R8

5G USE CASE	DESCRIPTION
<b>OOF - SON (5G)</b>	Optimization and SON functions for 5G RAN. Self-optimization, Self-Healing, Self-configuration.
<b>NETWORK SLICING (5G Use Case)</b>	Network Slicing defines Slices for 5G RAN systems. Network Slicing is a long-lead (multi-release) development. (will be presented in its own lecture at the Virtual Face to Face)
<b>MOBILITY STANDARDS HARMONIZATION/ A1 adapter</b>	A1 adapter: Enhancing the A1 adapter/interface capabilities in ONAP to manage A1 Policies, support multiple A1 targets in the RAN and multi-version A1 interface for different A1 targets, introduce secure TLS communication.
<b>STATE MANAGEMENT POC</b>	Bell Canada led PoC for State tracking and State management using C&PS Integration with C&PS (as a platform). Have the State management S/W now work with C&PS using available swaggers/APIs

# OOF / SON / PCI Use Case

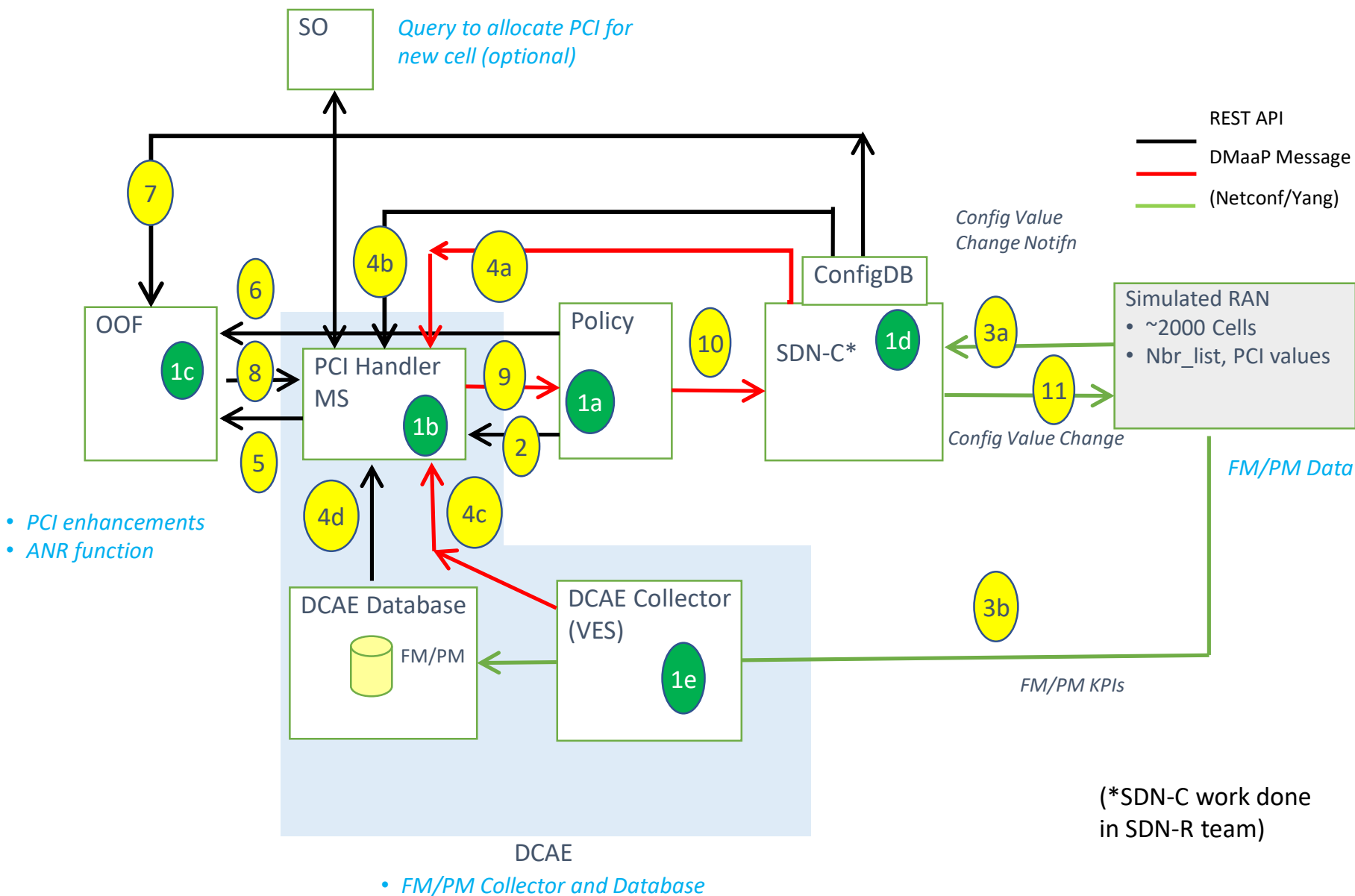

# End to End Network Slicing Use Case

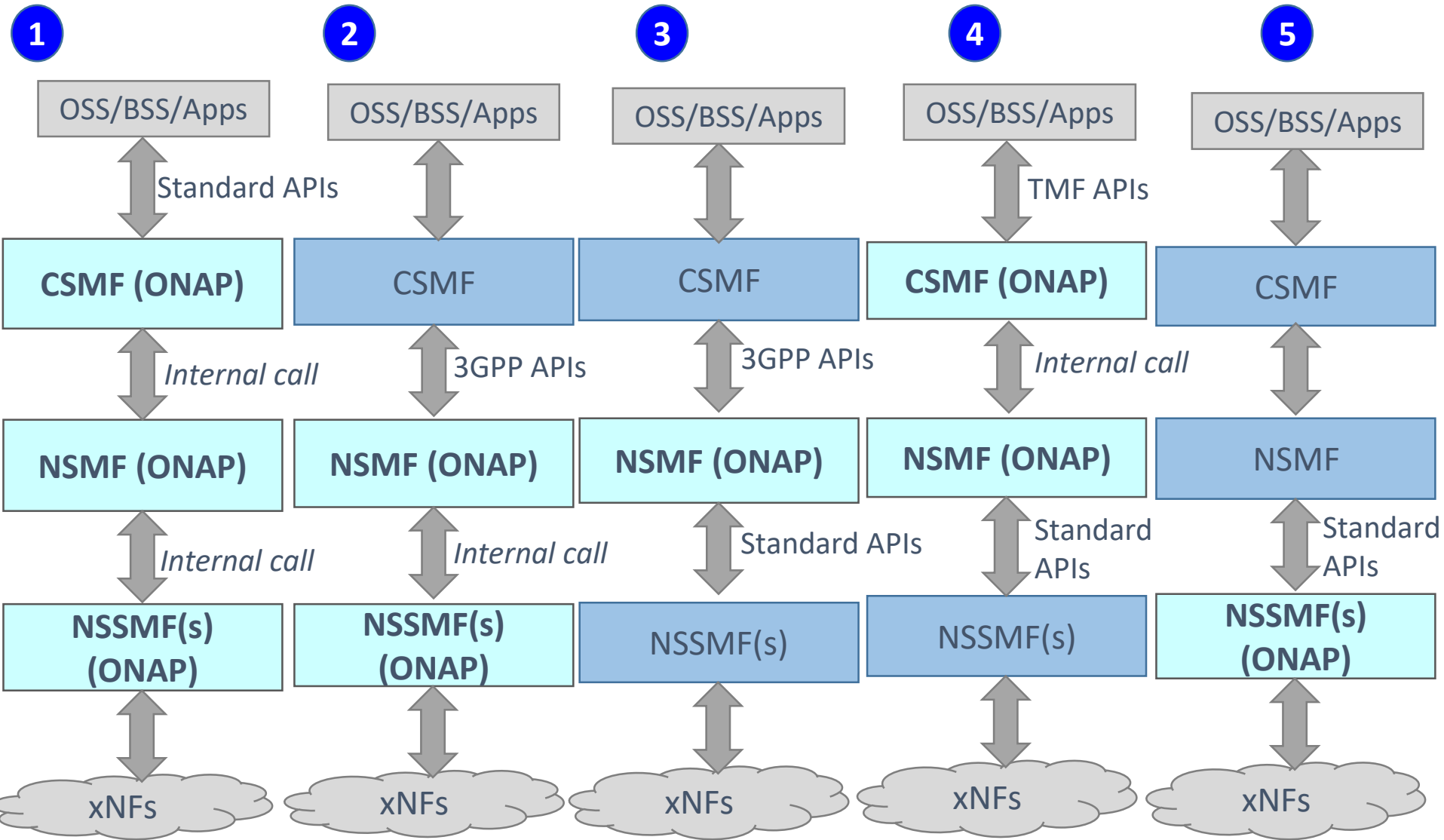

3<sup>rd</sup> party component

# A1 Policy Extension ORAN-ONAP Harmonize

**Executive Summary** - This requirement enhances the A1 adapter/interface capabilities provided in Rel 6 as part of 5G/ORAN & 3GPP Standards Harmonization requirement ( REQ-38). O-RAN has defined A1 interface specification in the context of the management of 5G RAN elements to provide intent based policies for optimization of the RAN network performance. Planned enhancements for Rel 7 include additional support for managing A1 Policies, multiple A1 targets in the RAN, multi-version support for different A1 targets, and secure TLS communication.

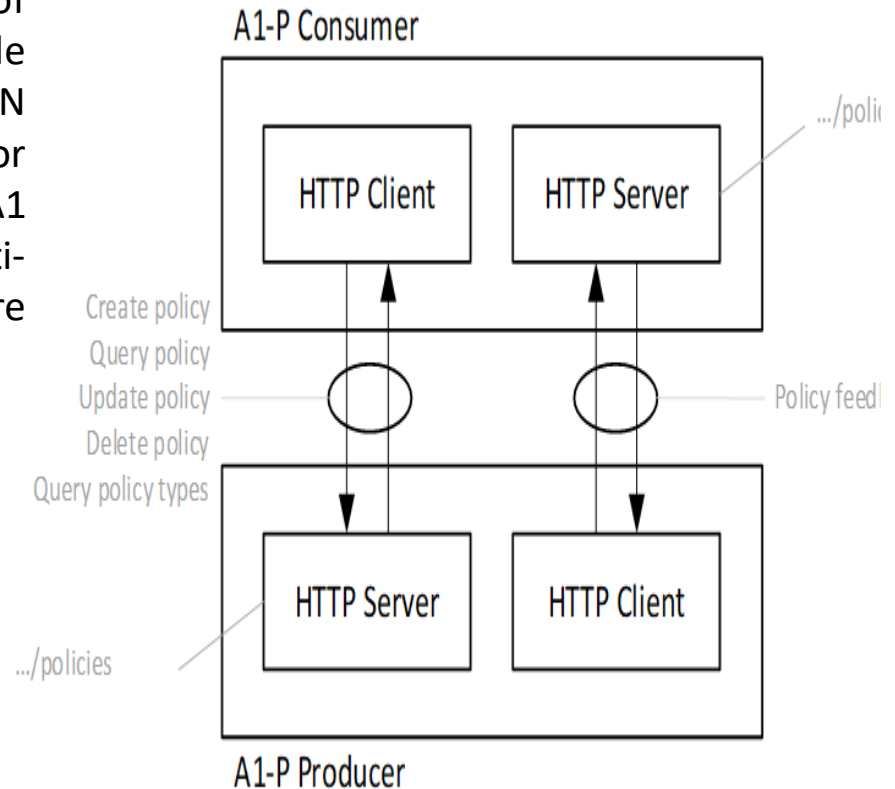

# State Management PoC (Bell Canada)

